

straightcurve®

Specifications

400mm Fixed Height Retainers & Planters

PANEL LENGTHS 400mm, 600mm, 800mm, 1000mm, 1200mm, 2000mm
TOP THICKNESS 46mm



Steel plate thickness 2mm

FINISHES

● Weathering Steel

ADDITIONAL ACCESSORIES

- ✓ Straight Join Set (12 x Tek Screws 12G x 16mm)
- ✓ Closed Corner Set (6 x Tek Screws 12G x 16mm)
- ✓ Open Corner Set (8 x Tek Screws 12G x 16mm)
- ✓ Universal bracing set
- ✓ Standard crossover Bracing Set
- ✓ Large anchor post (6 x Tek Screws 12G x 16mm)
(Fixing lip set sold separately)

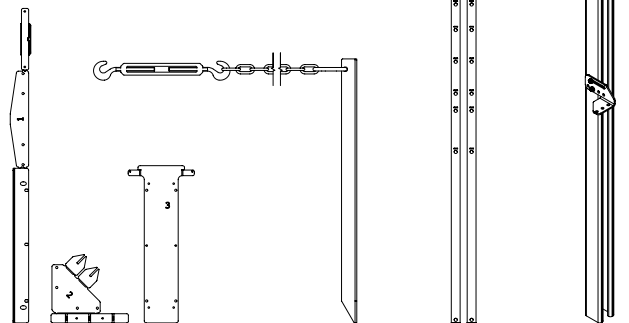

Installation guide

400mm Fixed Height Retainers & Planters



PREPARATIONS

Check you have the right panel sizes and join pieces (1,2 or 3) needed to achieve your goal. When building the planter box, do so on a flat work surface. Create a level installation base for set up. You may have several panel combinations that can make the same size bed so consider what combo will give the neatest seam arrangement where opposing straight joins align.

JOINING AND CORNER OPTIONS

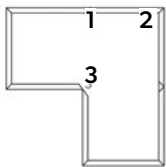

The three types of joining options include:

1. Straight join
2. Closed corner
3. Open corner

Important: Products are never shorter but sometimes slightly longer than indicated due to manufacturing tolerances. Be careful with tight spaces as our products might be bigger than expected.

1. STRAIGHT JOIN

A. BRING 2 PANELS TOGETHER

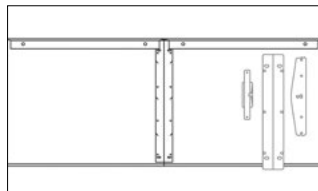

B. FIX IN TOP JOINER

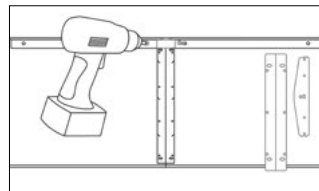

C. FIX IN BOTTOM JOINER

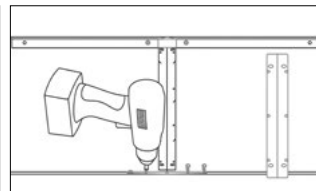

D. FIX IN CENTRAL JOINER

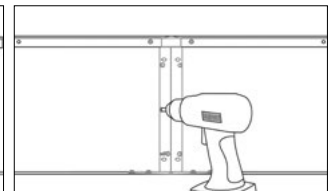

2. CLOSED CORNER

A. BEND TOP JOINER TO SHAPE

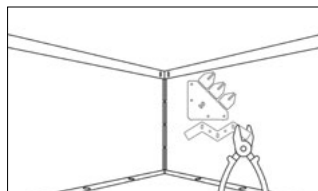

B. FIX IN TOP JOINER

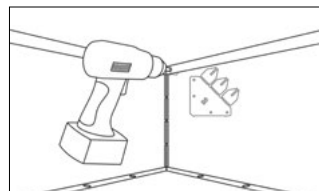

C. FIX IN BOTTOM JOINER

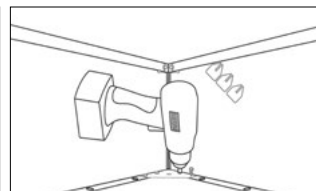

D. HAMMER IN CENTRAL TABS

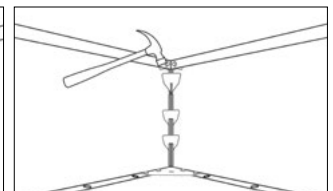

3. OPEN CORNER

A. BRING 2 PANELS TOGETHER

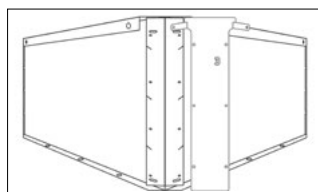

B. FIX IN JOINER AT TOP

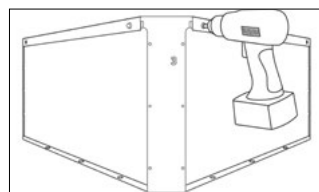

C. FIX ALONG THE SPINE

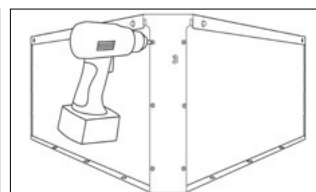

Note: Join pieces are completely concealed. They simply lock the panels together internally.

Installation guide

400mm Fixed Height Retainers & Planters



BRACING METHODS

Bracing is required wherever straight joins occur. For standard width beds (1200mm or less) use the standard crossover bracing set. For wide beds (>1200mm) or where using one wall of panels for retaining, use the universal bracing set connected to straight join top eye hole or large anchor post connected to panel itself at intervals. For large anchor posts the top and bottom edge lips are screwed to the post (the top lip tucks in under the folded top edge and the bottom one screws to the foot of the panel, see diagram right). If using 2000mm panels bracing at the middle point is recommended in addition to bracing at straight joins.

CROSSOVER BRACING INSTALLATION

1. Fit the braces between the straight joins top hole and the lower hole on the opposing side join, break to correct length to do this. (See diagram right)
2. Secure using lockpins supplied.

NB panel combinations with straight joins directly opposite required for this method.

