

75mm Garden Edging

For curved and straight edging situations.

Do you know what edging product is best for your project? Let's figure that out together here!

Firstly, what are you trying to do?



LAWN EDGE

Non-invasive grasses and ground covers

OR



PATHWAYS/RETAINING

Paving, stone and crush retainer edge

OR



DIVIDER

Divider between gravels/ woodchips/ mulches etc

Perhaps it looks something like these?

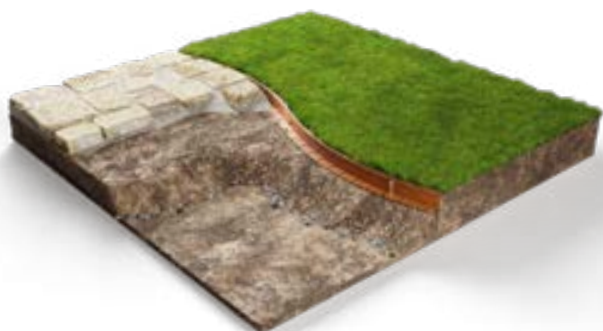

Straightcurve® Flex Garden Edging - 75mm

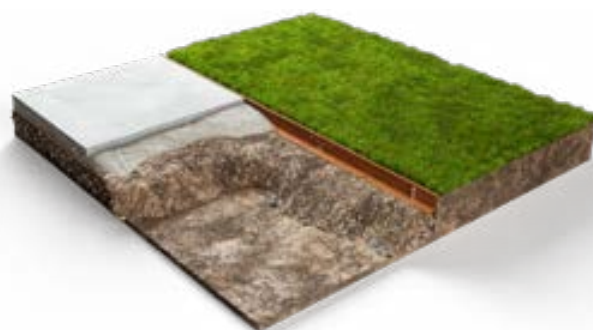

Straightcurve® Zero-Flex Garden Edging - 75mm

How do you choose from our two 75mm edging options?

We have a 75mm edge for curved or straight edging situations. Consider what matters to you so you can be sure of selecting the best option from our range. It's your call and we hope this selection table makes it easier!

I'm looking for...

We recommend for this ...

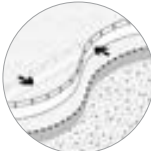
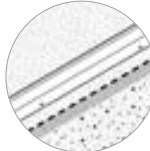
	 Flex - 75	 Zero Flex - 75
Something I can do myself	✓	✓
Something flexible enough to make tight curves with ease	✓	✗
Tree rings	✓	✗
Tree box surrounds	✗	✓
Something with no flex that helps me to create a straight run	✗	✓
A straight edge that will stay true and won't waver*	✗	✓
An edge ideally suited to run pavers up to, instead of a concrete haunch	✓	✓

*Preparation of a level compacted surface gives the best result, but this edge is vulnerable to forceful impacts. The Zero-Flex 100mm is a stronger option.

Did you know? It's also possible to combine styles, as our Flex Garden Edging and Zero-Flex Garden Edging are join and profile compatible.

Product overview

ROUNDED TOPS AND SAFETY FEATURES

The smooth, rolled tops and rounded connector plate corners assist safe handling. When installed, all joins/fixings are internal so that the exposed top and front present as a smooth top edge and continuous fascia.

SAFER AND CLEANER HANDLING

We recommend wearing gloves as the manufacturing process can leave residual oils/dust and our products can get hot when exposed to sunlight. Our products are shipped in bundles, when lifting bundles handlers should be mindful of their carrying capabilities. Single items are easy to carry for one person (see product weights).

ABOUT WEATHERING STEEL

The manufacturing process of weathering steel leaves the surface in a dark, almost black state. This dark 'finish' is an oxide layer that forms during the hot rolling process. The weathering process needs to break this layer down first before the desired protective patina layer can be established. You can expect some inconsistency in the patina formation because the thickness of the oxide layer varies; it'll appear spotty with some areas going orange and others still black.

The patina develops naturally with periods of wet and dry, and both phases are key for its steady formation. Do not wet continually without allowing time for thorough drying. A faster patina formation can be aided by cleaning the surface with soapy water to remove oil residue, but anything harsher is not advised as it can be detrimental to patina development and consequently, reduce product lifespan. Some rust solution products are safe to use as these 'build a surface patina' rather than just accelerating rusting.

WHAT IS A PATINA?

Patina is not the same as rust. All rust is patina, but not all patina is rust. Patina is a chemical bond between various elements and usually oxygen. It can be found on most metals with the exception of 8 inert (noble) metals like gold or silver. 'Normal' rust is iron-oxide, the patina referred to above is mostly a bond between copper, phosphorus, chromium, nickel, iron and oxygen. You may wonder, how does water feature in it? Water acts as an electrolyte, but that's a different story. In the end, the patina formed on

weathering steel is a dense layer that doesn't flake or allow oxygen through. Therefore, once formed, the oxidation process slows down dramatically.

LONGEVITY

Our products are of the highest quality ensuring longevity in the given environment. For further information please refer to the "Longevity Guide" and "Product Care Guide" on our website.

PAINTING, SEALING AND POWDERCOATING

Our galvanised products are suited to painting, but the surface should be thoroughly prepared (using acetone wash), and sealed with a metal primer (etch primer is very good) to maximise topcoat adhesion.

Powdercoating is a much more durable/hardy choice, and can be requested for large projects with lead times/costings supplied. It is worth noting that not all powdercoating performs the same, we use and recommend Interpon powder from AkzoNobel for assured quality and maximum endurance and suggest you request the same. It's also worth asking first to see a sample from your chosen powdercoater specialist.

Another question we get relates to freezing the colour (or patina development) at a certain stage. That's possible using a transparent sealant suitable for steel. Keep in mind that the colour will change when applying a sealant, it'll get a 'wet' look. Be sure to test this in a small inconspicuous area first before fully committing. This will require reapplication once a year.

WHEN IS CONCRETING AROUND THE FIXING SPIKES NECESSARY?

For sandy/soft/shifting ground conditions, consider setting the galvanised spikes into a small amount (3-5L) of concrete for extra hold. This is rarely required though, as the fill method tends to provide sufficient support for the buried edge and the 75mm edge is not performing a considerable load bearing function like taller profiles often do. Wetting down the sandy area prior improves stability during installation.

HOW TO POSITION THE EDGE?

This product has a back and a front facing side. Please consider which side will be the most visible in situ, based on your garden design and likely use of the area. This edge has a foot which is often used on the hard materials side (pavers/stone/crush) as their downward pressure increases edge rigidity with the hard materials built up to the top of the edge.

Fills such as mulch and stone may settle at lower than the install level and so require topping up later to maintain the look initially achieved. This top up practice can also increase lifespan, as the protective patina formation may be inconsistent in previously buried portions.

HOW DEEP DO I BURY THE EDGE?

This edge is designed to be mostly buried both in terms of the aesthetic finish and to maximise it's strength and durability. You may choose to leave the top portion (around 2cm) of the edge proud to help with material separation and containment, or for lawn maintenance practices of strimming against the edge itself. Not burying the edge at all will leave joint systems visible and see the edge vulnerable to damage.

WHY DO WE SUPPLY AND RECOMMEND TEK SCREWS?

You will see the pre-attached connector plate is fixed to the edge with rivets. This is the best method in the factory but when installing our edging Tek screws are a faster, stronger and easier option.

The long lasting, grey Dacromet® Tek screws are best for all buried screw locations. With a weathering steel install, and on the rare occasions when the screws are visible the zinc colour Tek screws are used as they rust over, making them less aesthetically intrusive.

However, if you choose to use rivets be sure to use stainless steel and not aluminium which will disappear within a year or so. Aluminium, like zinc, is a sacrificial anode that protects the steel by sacrificing itself.

ADVANTAGES

- ✓ Continuous smooth rolled tops
- ✓ Free standing for shape adjustment
- ✓ Strong, penetrative fixing spikes
- ✓ No welding required
- ✓ Up to 3x faster installation
- ✓ Designed for ease of use

Straightcurve® Flex Garden Edging - 75mm

FL075WS WEATHERING STEEL | FL075GS GALVANISED STEEL

Product features

The details that make the difference

Pre-attached connector plate and guide holes for precise and discreet joins

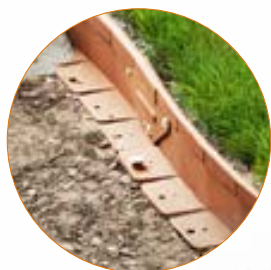

Notched design for smooth, even curves



6mm rounded tops for child and pet safety

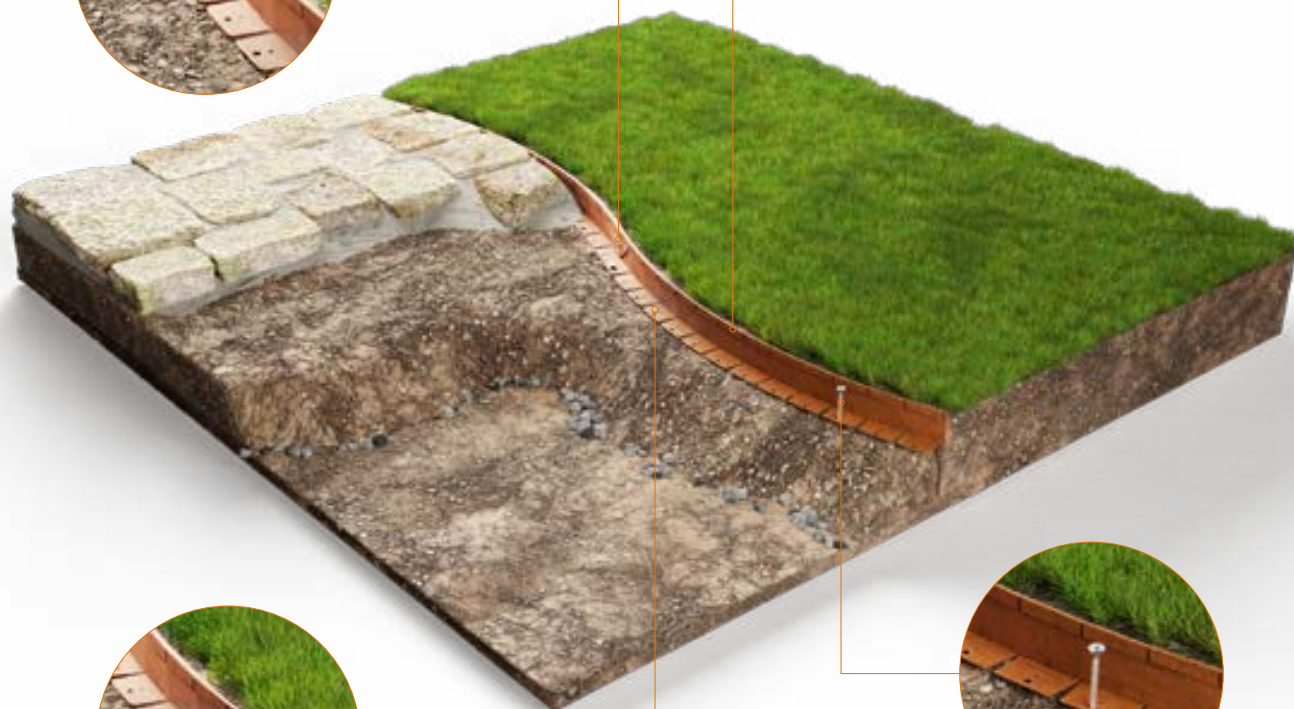

Positioning feet for stable set up

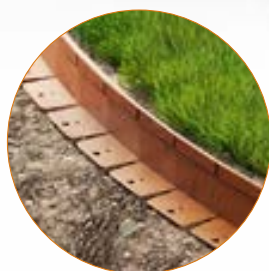

Moveable fixing spikes for easy obstacle avoidance

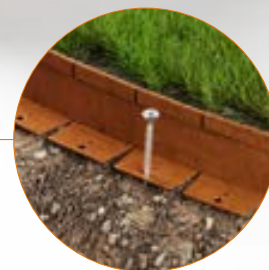

EDGE STYLE**FINISHES**

- Galvanised Steel
- Weathering Steel

For smoothly curving edging applications that hold position once shaped and installed.

Product specifications

TECHNICAL SPECIFICATIONS

Length (Installed)	2200mm
Top edge thickness	6mm
Steel plate thickness	1.6mm
Weight per length	3.7kg

BULK BUYING

Pack quantity	70
Bulk pack weight inc. pallet	280kg

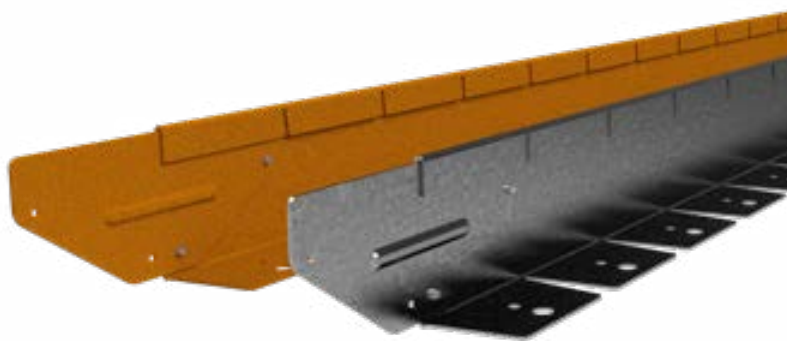
**SOLD AS SET INCLUDING**

- 1 x Connector plate (pre-attached)
- 3 x Galvanised spikes, 300mm long

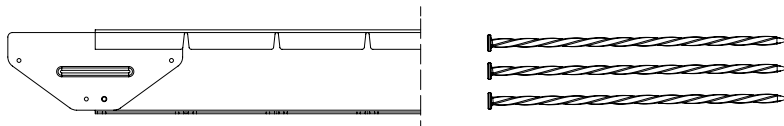

75mm Flex Installation Guide

Scan or click to watch install video



REQUIRED FIXINGS

- 2 x Tek Screws (12G x 16mm) or
- 2 x pop rivets (4mm shaft)

RECOMMENDED TOOLS

- Ground leveling tools
- Rubber mallet
- Cordless drill and Tek screw bit
- Angle grinder (required if modifying lengths or fashioning corners/ends)

PREPARATIONS

Mark the intended line on the ground. You might lay out a garden hose or try line marking paint if this helps visualise the design. Measure the length of edge needed.

For a lower finishing height, make a trench to sit the edge into. A firm level base is easier to work on, so if working on loose sand wet the area down first.

Note: This edge allows gentle sloping and corners are simply bent in.

DO...

- ✔ Consider the best edge orientation in terms of smooth face viewing.
- ✔ Join all lengths in place and perfect the line before fixing in final position.
- ✔ Use some spikes to hold partially in place while reviewing position.
- ✔ Flex rather than bend, especially if creating rings.
- ✔ Use some 75mm Zero-Flex lengths if your design has some straight sections, they're compatible!

DON'T...

- ✘ Use for straight lines, instead use 75mm Zero-Flex.
- ✘ Forcibly bend. Take care and gently flex the edge to shape.
- ✘ Accelerate rust with acids or salts.
- ✘ Leave a square top corner unsafely protruding at an end, cap or round it off with a grinder instead.

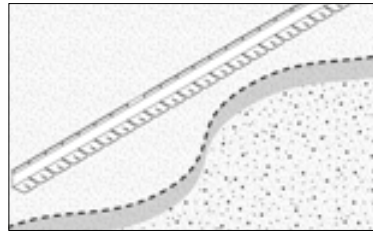

STEP 1 - Mark out edge line, prepare ground and place edges nearby.

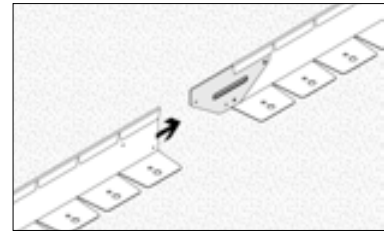

STEP 2 - Slide connector plate of one edge into the next to connect.

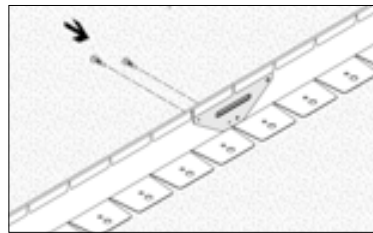

STEP 3 - Secure together with Tek screws through aligned guide holes.

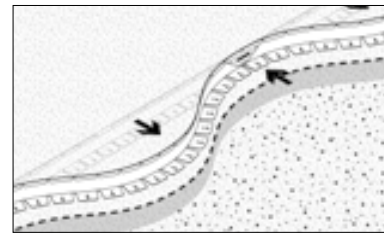

STEP 4 - Introduce further lengths, flex to shape and join as you go.

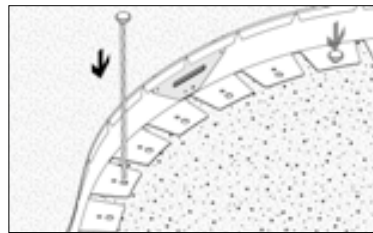

STEP 5 - Fix edge foot tabs with twisted nails in desired position.

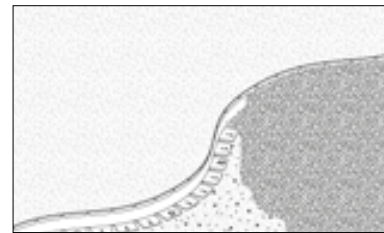

STEP 6 - Backfill to finish.

CORNERS - Corners are easily bent in by hand and with use of a rubber mallet. First raise up the foot tab adjacent the bend point so it's out of the way. Then bend in the corner and finish shaping with a rubber mallet.

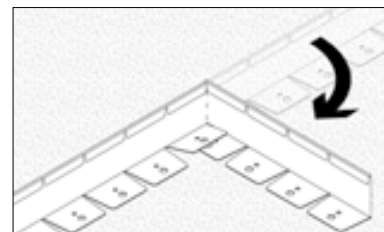
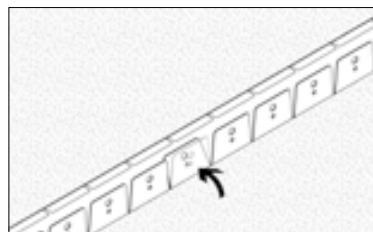

CIRCLES AND TIGHT CURVES

One length makes a tight 70cm diameter circle. Take care to gently flex the edge (i.e. do not bend) when forming the ring. Once the connector plate is aligned, Tek screw through the guide holes, then carefully adjust ring shape to your liking and fix to ground. Use a rubber mallet for making subtle shape adjustments.

The tight ring made with one length is not completely smooth on the inside. You can add part of a length (which requires cutting) to get a smoother result. Using whole lengths only the diameters increase with each additional length, i.e. 141cm, 212cm, 283cm and so on. As a guide the tightest curves without kinking the steel is equivalent to a radius of around 35cm.

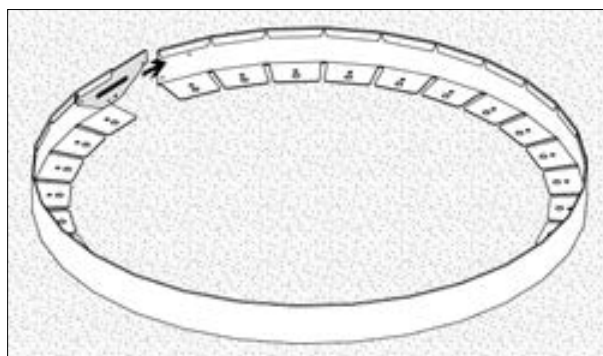

INSTALLING ON HARD SURFACES

The galvanised spikes will penetrate very hard ground, but use a bolt down option (galvanised bolts) for concrete or other impenetrable surfaces. On impermeable surfaces use packers to elevate the edge slightly; allowing drainage away from edge.

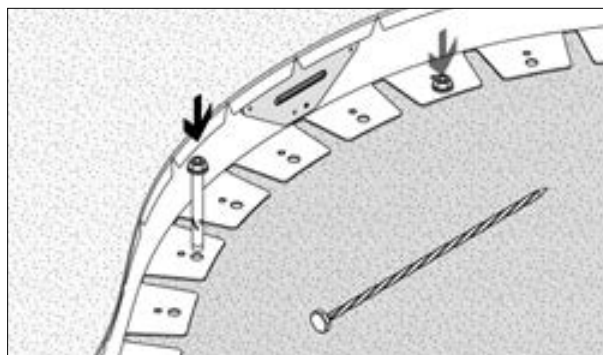

COMPATIBILITY

The 75mm Flex is compatible with the 75mm Zero-Flex, because the joining plates and edge profile are exactly the same. Where a layout requires curved sections and straight sections order some of each to best meet the design plan.

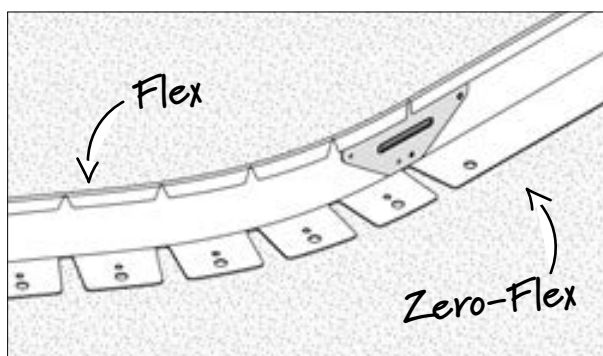

Straightcurve® Zero-Flex Garden Edging - 75mm

RL075WS WEATHERING STEEL | RL075GS GALVANISED STEEL

Product features

The details that make the difference

Pre attached connector plate and guide holes for precise and discreet joins

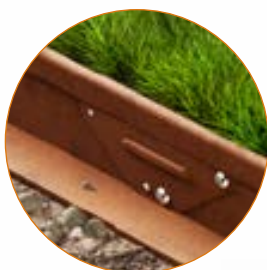

6mm rounded tops for child and pet safety



Continuous rolled top teams with angled foot for more rigid lines



Positioning feet for stable set up

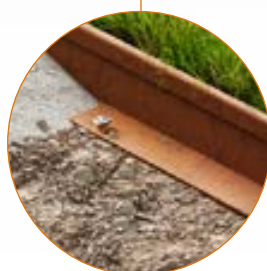

Moveable fixing spikes for easy obstacle avoidance

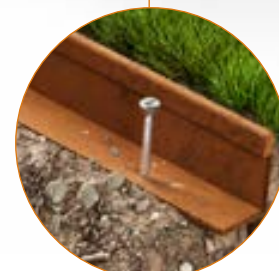

EDGE STYLE**FINISHES**

- Galvanised Steel
- Weathering Steel

For creating straight lines that look good down the line.

Product specifications

TECHNICAL SPECIFICATIONS

Length (Installed)	2200mm
Top edge thickness	6mm
Steel plate thickness	1.6mm
Weight per length	3.7kg

BULK BUYING

Pack quantity	70
Bulk pack weight inc. pallet	280kg

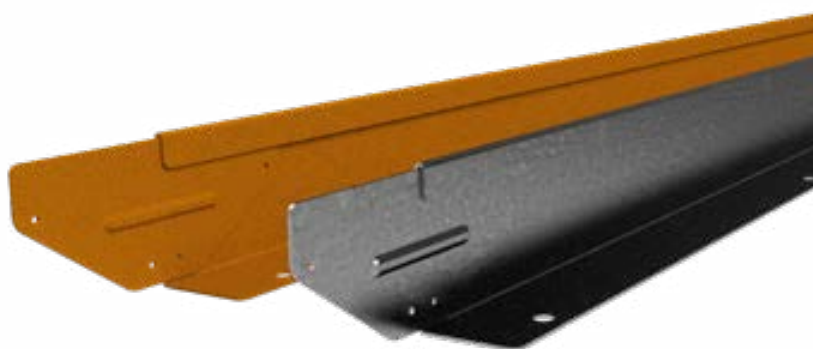
**SOLD AS SET INCLUDING**

- 1 x Connector plate (pre-attached)
- 3 x Galvanised spikes, 300mm long

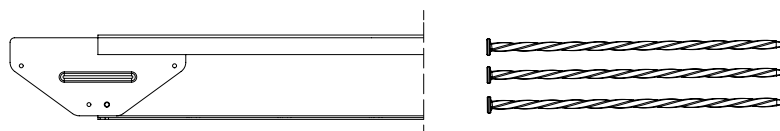
**ADDITIONAL ACCESSORIES**

- 500mm Corner piece (250 + 250mm arms, bend to desired angle)

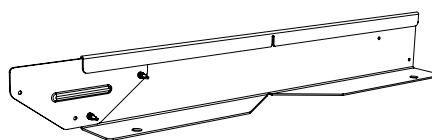

75mm Zero-Flex Installation Guide

Scan or click to watch install video



REQUIRED FIXINGS

- 2 x Tek Screws (12G x 16mm) or
- 2 x pop rivets (4mm shaft)

RECOMMENDED TOOLS

- Ground leveling tools
- Rubber mallet
- Cordless drill and Tek screw bit
- String line/line marking aid
- Angle grinder (required if modifying lengths or fashioning ends)

PREPARATIONS

Mark the intended line on the ground to measure what length of edge is needed. For a lower finishing height, make a shallow trench to partially bury the edge. A firm, level base is easier to work on, so if working on loose sand, wet down first. With the surface ready a string line or similar aid is useful to assist edge placement.

Note: This edge will not flex for gentle curves, it is for straight lines only.

DO...

- ✔ Consider the best edge orientation in terms of smooth face viewing.
- ✔ Ensure the install surface is levelled before installing.
- ✔ Join all lengths in place and check the line before finally fixing in position.
- ✔ Introduce or make corners where needed for a continuous top edge line.
- ✔ Use some spikes to hold partially in place while reviewing position.
- ✔ Use some 75mm Flex lengths if your design has some curved sections, they're compatible!

DON'T...

- ✘ Try to bend, instead use 75mm Flex for any curved sections.
- ✘ Accelerate rust with acids or salts.
- ✘ Leave a square top corner unsafely protruding at an end, cap or round it off with a grinder instead.

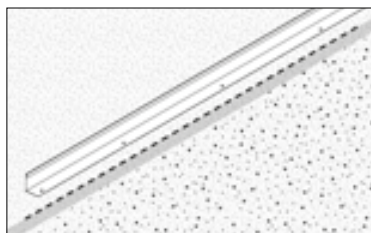

STEP 1 - Mark out edge line on ground and position edges on the desired line.

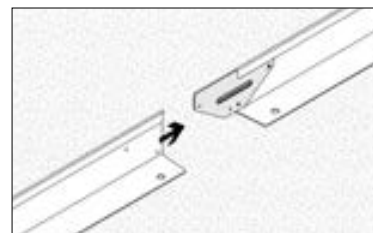

STEP 2 - Slide connector plate of one edge into the next to connect.

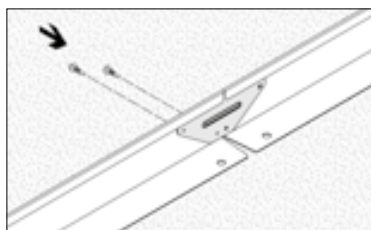

STEP 3 - Secure together with Tek screw through aligned guide holes.

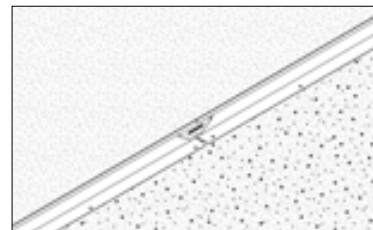

STEP 4 - Introduce further lengths, connecting them as you go.

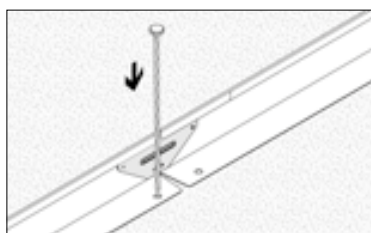

STEP 5 - Fix edge foot tabs with twisted nails in desired position.

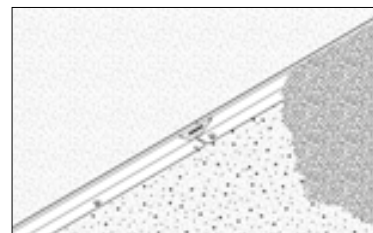

STEP 6 - Backfill to finish.

CORNERS - Corners are available for purchase or you can choose to make your own. Making your own corners will likely mean less waste, as the corners are simply made where they are needed with no offcuts created.

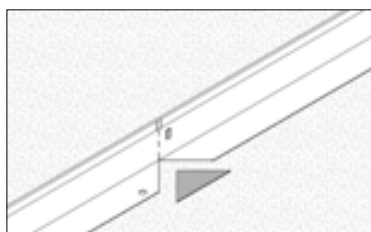

STEP 1 - Use angle grinder to score a line down the back of the edge and cut out these required gaps



STEP 2 - Bend by hand (past the 90 then back for right angles) and perfect shape with rubber mallet.

- i) 5-7mm of the folded lip at the top; and
- ii) A wide triangular piece from foot (angle exceeding 90 degree)

GEOMETRIC SHAPES

You may look to create the likes of rectangles, squares or other linear shapes and patterns. To do so measure carefully and create the corners where needed.

When making basic corners, creating a foot gap larger than the space required allows you to bend past and return to the 90 degree angle which is helpful in getting it 'just right.'

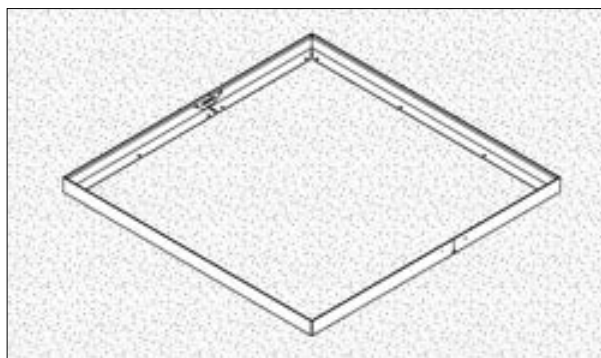

INSTALLING ON HARD SURFACES

The galvanised spikes will penetrate very hard ground, but use a bolt down option for concrete or other impenetrable surfaces. On impermeable surfaces use packers to elevate the edge slightly; allowing drainage away from edge.

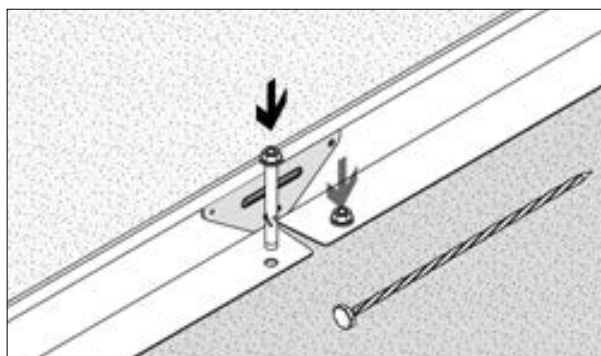

COMPATIBILITY

The 75mm Zero-Flex is compatible with the 75mm Flex, because the joining plates and edge profile are exactly the same. Where a layout requires straight sections and curved sections order some of each to best meet the design plan.

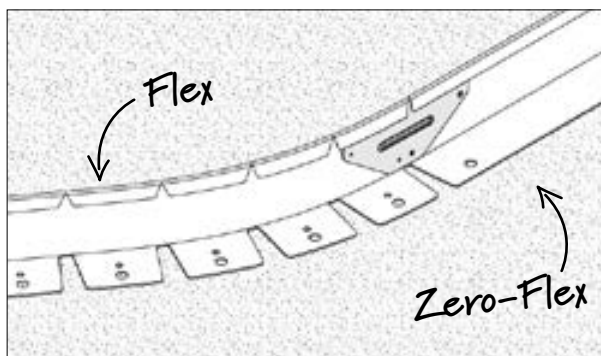

Technical Drawings

STRAIGHTCURVE® FLEX GARDEN EDGING - 75MM

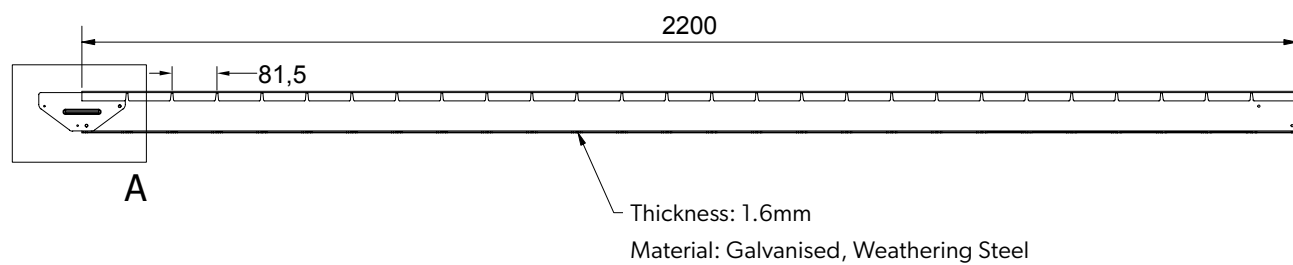

STRAIGHTCURVE® ZERO-FLEX GARDEN EDGING - 75MM

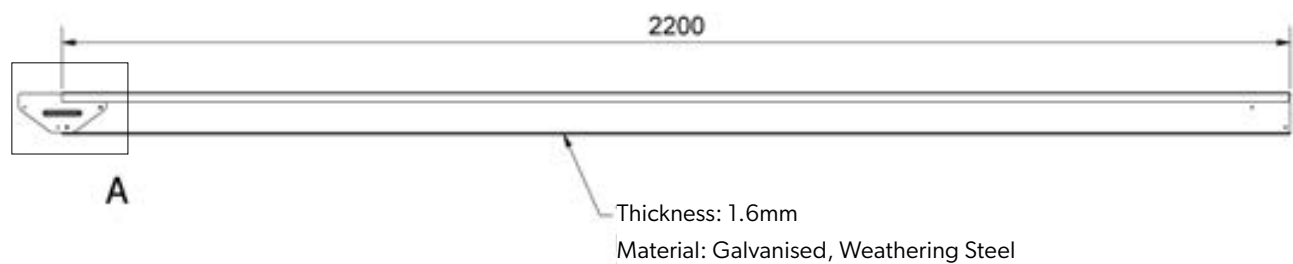



SIDE PROFILE



CONNECTOR PLATE

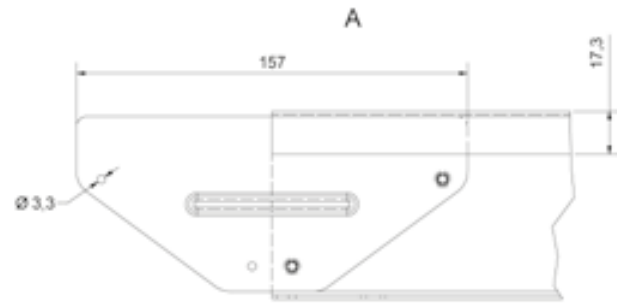

STRAIGHTCURVE® ZERO-FLEX GARDEN EDGING - 75MM - CORNER

