

100mm Garden Edging

For curved and straight edging situations.

Do you know what edging product is best for your project? Let's figure that out together here!

Firstly, what are you trying to do?



LAWN EDGE

Lawn edge for non-invasive grasses and ground covers

OR



PATHWAYS/RETAINING

Paving, stone and crush retainer edge

OR



DIVIDER

Divider between gravels/ woodchips/ mulches etc

Perhaps it looks something like these?



Straightcurve® Flex Garden Edging - 100mm



Straightcurve® Zero-Flex Garden Edging - 100mm

How do you choose from our three 100mm edging options?

We have solutions for curved and straight edging situations. Consider what matters to you so you can be sure of selecting the best option from our range. It's your call and we hope this selection table makes it easier!

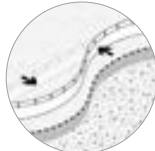
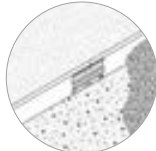
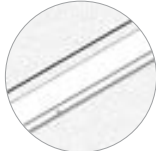
I'm looking for...	We recommend for this ...		
	 Flex - 100	 Rigid - 100	 Zero-Flex - 100
Something I can do myself	✓	✓	✓
Something flexible enough to make tight curves with ease	✓	✗	✗
Tree rings	✓	✗	✗
An edge that creates a strong gentle curve, for a radius exceeding 4m	✗	✓	✗
Something rigid that helps me to create a straight run	✗	✓	✓
A straight edge that will stay true and won't waver	✗	✗	✓
An edge ideally suited to run pavers up to, instead of a concrete haunch	✗	✗	✓

Did you know? It's also possible to combine styles, as our Flex Garden Edging and Rigid Garden Edging are join and profile compatible. Flex edging can also be modified to join the Zero-Flex edge neatly.

Product overview

ROUNDED TOPS AND SAFETY FEATURES

The smooth, rolled tops and rounded connector plate corners assist safe handling. When installed, all joins/fixings are internal so that the exposed top and front present as a smooth top edge and continuous fascia.

SAFER AND CLEANER HANDLING

We recommend wearing gloves as the manufacturing process can leave residual oils/dust and our products can get hot when exposed to sunlight. Our products are shipped in bundles, when lifting bundles handlers should be mindful of their carrying capabilities. Single items are easy to carry for one person (see product weights).

ABOUT WEATHERING STEEL

The manufacturing process of weathering steel leaves the surface in a dark, almost black state. This dark 'finish' is an oxide layer that forms during the hot rolling process. The weathering process needs to break this layer down first before the desired protective patina layer can be established. You can expect some inconsistency in the patina formation because the thickness of the oxide layer varies; it'll appear spotty with some areas going orange and others still black.

The patina develops naturally with periods of wet and dry, and both phases are key for its steady formation. Do not wet continually without allowing time for thorough drying. A faster patina formation can be aided by cleaning the surface with soapy water to remove oil residue, but anything harsher is not advised as it can be detrimental to patina development and consequently, reduce product lifespan. Some rust solution products are safe to use as these 'build a surface patina' rather than just accelerating rusting.

WHAT IS A PATINA

Patina is not the same as rust. All rust is patina, but not all patina is rust. Patina is a chemical bond between various elements and usually oxygen. It can be found on most metals with the exception of 8 inert (noble) metals like gold or silver. 'Normal' rust is iron-oxide, the patina referred to above is mostly a bond between copper, phosphorus, chromium, nickel, iron and oxygen. You may wonder, how does water feature in it? Water acts as an electrolyte, but

that's a different story. In the end, the patina formed on weathering steel is a dense layer that doesn't flake or allow oxygen through. Therefore, once formed, the oxidation process slows down dramatically.

LONGEVITY

Our products are of the highest quality ensuring longevity in the given environment. For further information please refer to the "Longevity Guide" and "Product Care Guide" on our website.

PAINTING, SEALING AND POWDERCOATING

Our galvanised products are suited to painting, but the surface should be thoroughly prepared (using acetone wash), and sealed with a metal primer (etch primer is very good) to maximise topcoat adhesion.

Powdercoating is a much more durable/hardy choice, and can be requested for large projects with lead times/costings supplied. It is worth noting that not all powdercoating performs the same, we use and recommend Interpon powder from AkzoNobel for assured quality and maximum endurance and suggest you request the same. It's also worth asking first to see a sample from your chosen powdercoater specialist.

Another question we get relates to freezing the colour (or patina development) at a certain stage. That's possible using a transparent sealant suitable for steel. Keep in mind that the colour will change when applying a sealant, it'll get a 'wet' look. Be sure to test this in a small inconspicuous area first before fully committing. This will require reapplication once a year.

HOW TO POSITION THE EDGE

The Flex and Rigid Garden Edging have a back and a front facing side. Consider which side will be the most visible in situ, based on your garden design and likely use of the area. For example, in a lawn edging install the smooth side would often face the lawn side so a smooth top portion presents with the neatly clipped lawn. These two edge styles do not have a foot which makes them ideal for retrofits along slightly crowded garden bed edges.

The Zero-Flex Garden Edging has no back or front facing side, so it looks smooth from both directions. The fixing screws and galvanised nails are used in the foot portion only, so they are hidden by the fill material used.

Fills such as mulch and stone may settle at lower than the install level and so require topping up later to maintain the look initially achieved. This top up practice can also increase lifespan, as the protective patina formation may be inconsistent in previously buried portions.

HOW DEEP DO I BURY THE EDGE?

The Flex and Rigid Garden Edging is designed to be mostly buried both in terms of the aesthetic finish and to maximise its strength and durability. Curved installs do generate a strength of their own so some layouts allow Flex to be set higher and still maintain its line well. Not burying the edge at all will leave join systems visible and see the edge more vulnerable to damage.

The Zero Flex Garden edging only requires partial burying to hide the foot, but when mostly buried its strength and durability are greatest of all. Installed on a firm base and with fill near flush to the top of the edge it is impressively strong.

You may choose to leave a portion of the edge proud to help with material separation and containment, or for lawn maintenance practices of strimming against the edge itself.

WHY DO WE SUPPLY AND RECOMMEND TEK SCREWS?

You will see the pre-attached connector plate is fixed to the edge with rivets. This is the best method in the factory but when installing our edging Tek screws are a faster, stronger and easier option. We recommend using Tek screws to make life easier! The long lasting, grey Dacromet® Tek screws are recommended for all internal(buried) screw locations. With a weathering steel install, and on the rare occasions when the screws are visible the zinc colour Tek screws are used as they rust over, making them less aesthetically intrusive.

However, if you choose to use rivets be sure to use stainless steel and not aluminium which will disappear within a year or so. Aluminium, like zinc, is a sacrificial anode that protects the steel by sacrificing itself.

ADVANTAGES

- ✓ Continuous smooth rolled tops
- ✓ Corners available or easily made in situ
- ✓ Up to 3x faster installation
- ✓ No welding required
- ✓ No Experience/training needed
- ✓ Designed for ease of use

Straightcurve® Flex Garden Edging - 100mm

FL100WS WEATHERING STEEL | FL100GS GALVANISED STEEL

Product features

The details that make the difference



Connector plate and guide holes for precise and discreet joins



8mm Rounded Tops for child and pet safety

Double Rolled, Notched Top for smooth, even curves



Discreet presence for retrofits and design integrity

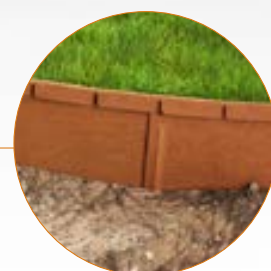

Moveable Lock-in Peg for easy obstacle avoidance

EDGE STYLE



For smoothly curving edging applications that hold position once shaped and installed.

FINISHES

- Galvanised Steel
- Weathering Steel

Product specifications

TECHNICAL SPECIFICATIONS

Length (Installed)	2200mm
Top edge thickness	8mm
Steel plate thickness	1.6mm
Weight per length	4.0kg

BULK BUYING

Pack quantity	70
Bulk pack weight inc. pallet	300kg

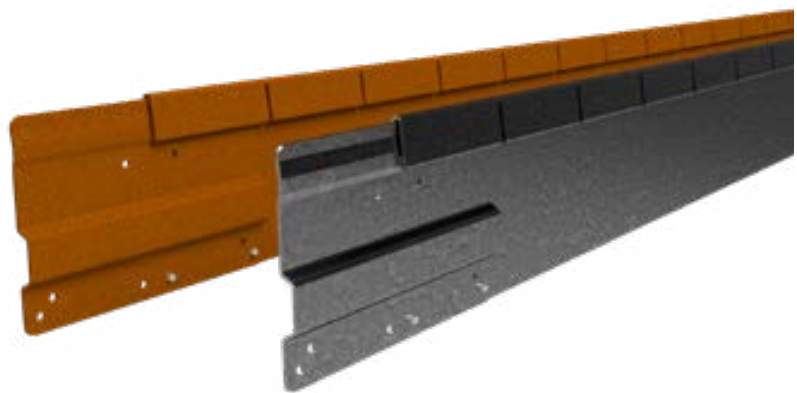

SOLD AS SET INCLUDING

- 1 x Connector plate (pre-attached)
- 3 x Fixing pegs, 300mm long



ADDITIONAL ACCESSORIES

- 500mm Corner piece (250 + 250mm arms, bend to desired angle)
- Hard surface fixing bracket
- Heavy duty peg

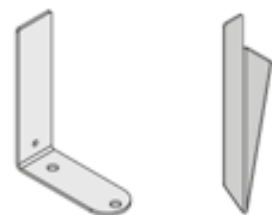

100mm Flex Installation Guide

Scan or click to watch install video

▶ INSTALL GUIDE



REQUIRED FIXINGS

- 2 x Tek Screws (12G x 16mm) or
- 2 x pop rivets (4mm shaft)

RECOMMENDED TOOLS

- Ground leveling tools
- Rubber mallet
- Cordless drill and Tek screw bit
- Angle grinder (only required if modifying lengths or fashioning ends)

PREPARATIONS

Mark the intended line on the ground and measure what length of edge is needed. Making a trench to set the edge into may be necessary. This will dictate the amount of edge that finishes proud and visible for your buried edge. For a retrofit, where surrounding heights are set, trench relative to these. For a new garden where surrounding materials may be added, the edge is sometimes installed without a trench, and then materials are filled up to and around it. Either way, burying the edge more deeply adds strength and assists curve support. Consider the 150mm or 240mm edge if more visibility of edge face is desired.

Note: This edge allows gentle sloping. Corners can be made or purchased as accessories. Length excess is cut away with angle grinder tool.

DO...

- ✓ Consider the best edge orientation in terms of smooth face/top edge viewing
- ✓ Join all lengths in place and perfect the line before finally fixing in position.
- ✓ Use some pegs to hold partially in place while reviewing position
- ✓ Flex rather than bend, especially if creating rings
- ✓ Use some Rigid lengths if your design has some straight sections, they have compatible connectors!

DON'T...

- ✗ Use for straight lines, instead use Rigid
- ✗ Forcibly bend. Take care and gently flex the edge to shape
- ✗ Accelerate rust with acids or salts, that's harmful to patina development
- ✗ Leave a square top corner unsafely protruding at an end, cap or round it off with a grinder instead.

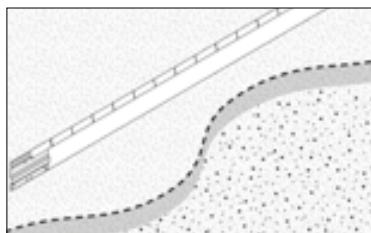

STEP 1 - Mark edge line on ground or by trenching and layout edge pieces.

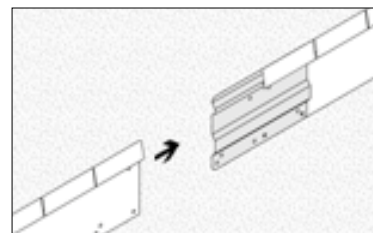

STEP 2 - Slide connector plate of one into the next to connect.

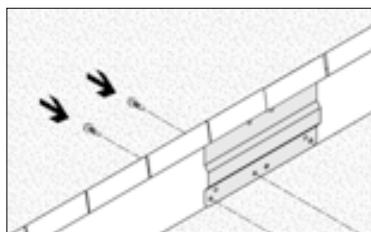

STEP 3 - Secure together with Tek screw through aligned guide holes.

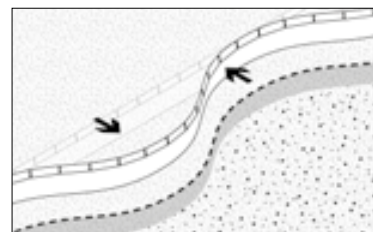

STEP 4 - Place, flex and connect all lengths along line, check line using pegs as temporary placeholders if needed.

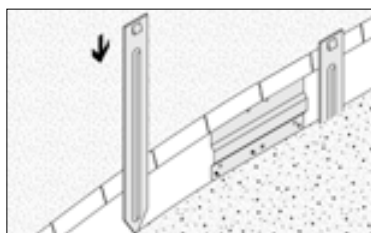

STEP 5 - Hammer all pegs adjacent edge (three per length) leaving them just above finishing height.

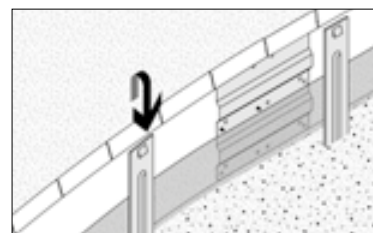

STEP 6 - Place edge onto pegs.

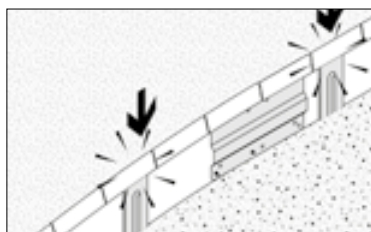

STEP 7 - Use rubber mallet to hammer edge on so peg locks in. Work down the line.

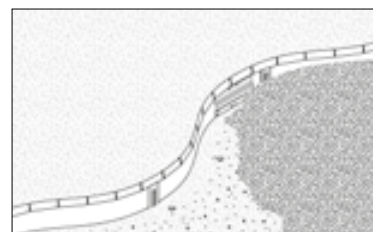

STEP 8 - Firming can be done with the rubber mallet, then backfill to finish.

CORNERS

Standard corners are available for purchase, but you can choose to make your own. Making your own corners will likely mean less waste, as the corners are simply made where they are needed with no offcuts created.

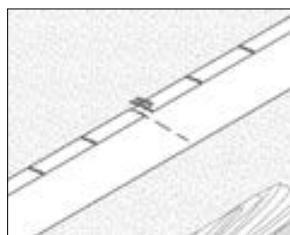

STEP 1 - Score a line down the back of the edge and create a sufficient opening (5-7mm) in the double folded lip at the top.

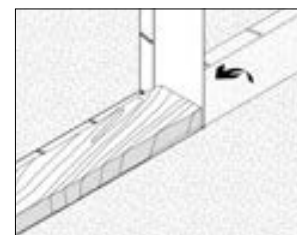

STEP 2 - Bend by hand. Placing a block of wood close to the fold improves the result.

JOINING EDGE TO A SURFACE OR ROCK

A join tab can be made using an angle grinder. This involves cutting away the top lip portion and scoring a fragmented fold line for the remaining tab piece. The tab is then bent as required for fixing and screwing to the surface it joins.

If butting up to a rock, using a diamond tip blade to cut a slot in the rock itself allows the edge to sit into it snugly, or just use the rock to hide the edge end safely behind it.

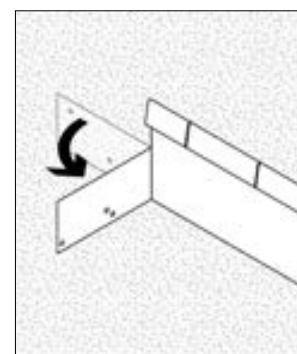
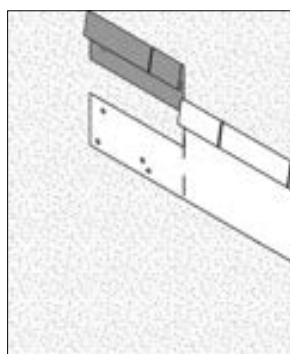

INSTALLING ON HARD SURFACES

Where ground conditions are too hard for standard pegs to penetrate, the Heavy Duty Peg may be used instead. These are first driven into the ground (hammer the hip, not the top part) and then the edge is hammered onto them with a rubber mallet to firmly wedge the Heavy Duty Peg in under the edge rim.

Alternatively the Hard Surface Fixing Bracket may be used. This also wedges firmly in under the edge rim when the edge is hammered onto it with a rubber mallet. This Hard Surface Fixing Bracket can be secured through the holes in the foot with galvanised spikes in hard ground or with DynaBolts™ when fixing to concrete. The DynaBolts™ or Fixing spikes utilised do not come with the bracket so need to be acquired separately.

On impermeable surfaces such as concrete, use packers to elevate the edge slightly; allowing drainage away from edge.

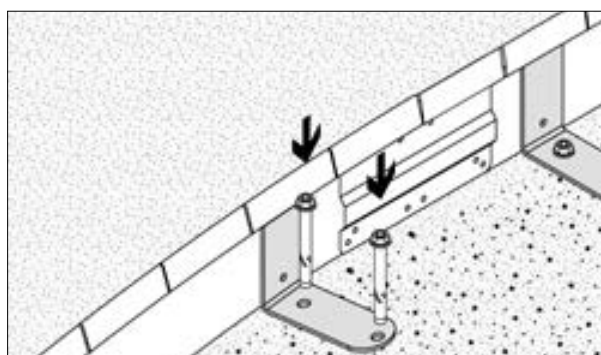
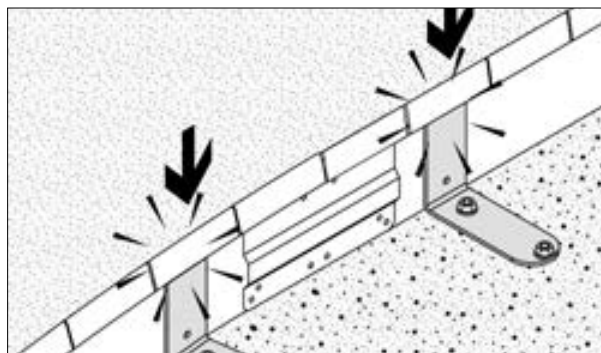

CIRCLES AND TIGHT CURVES

One length makes a tight 70cm diameter circle. Take care to gently flex the edge (i.e. do not bend) when forming the ring. Once the connector plate is aligned, Tek screw through the guide holes, then carefully adjust ring shape to your liking and fix to ground.

The tight ring made with one length is not completely smooth on the inside. You can add part of a length (which requires cutting) to get a smoother result. Using whole lengths only the diameters increase with each additional length, i.e. 141cm, 212cm, 283cm and so on.

As a guide the tightest curves without kinking the steel is equivalent to a radius of around 35cm. A further tip to achieve a tighter curve is to use your angle grinder to cut additional notches into the top lip in the section where it's needed.

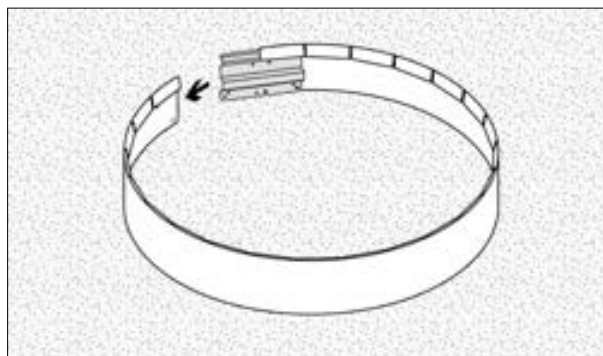

COMPATIBILITY

The 100mm Flex is compatible with the 100mm Rigid, because the joining plates and edge profile are exactly the same. This means you can use both together on the same project!

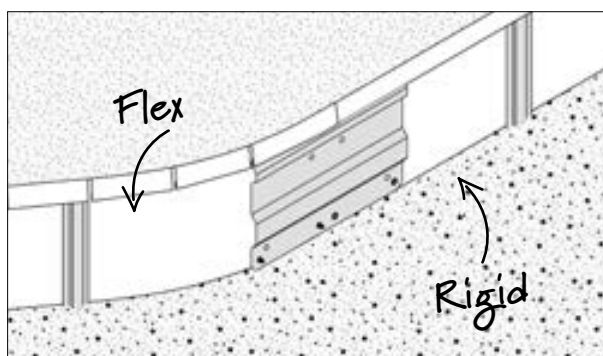

Straightcurve® Rigid Garden Edging - 100mm

RL100WS WEATHERING STEEL | RL100GS GALVANISED STEEL

Product features

The details that make the difference



Connector plate and guide holes for precise and discreet joins



8mm rounded tops for child and pet safety

Double rolled, continuous top for rigid straight lines

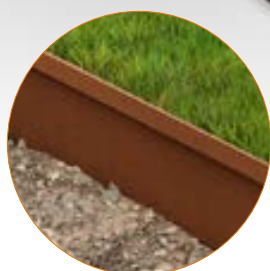

Discreet presence for retrofits and design integrity



Moveable lock-in peg for easy obstacle avoidance

EDGE STYLE



FINISHES

- Galvanised Steel
- Weathering Steel

For creating straight or slightly curving lines

Product specifications

TECHNICAL SPECIFICATIONS

Length (Installed)	2200mm
Top edge thickness	8mm
Steel plate thickness	1.6mm
Weight per length	4.0kg

BULK BUYING

Pack quantity	70
Bulk pack weight inc. pallet	300kg

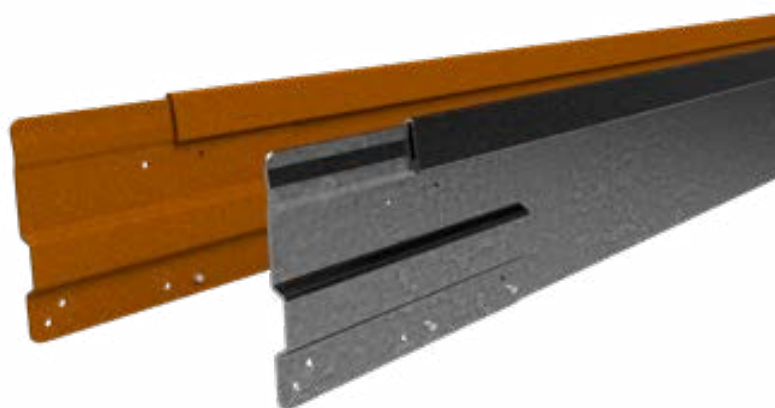

SOLD AS SET INCLUDING

- 1 x Connector plate (pre-attached)
- 3 x Fixing pegs, 300mm long



ADDITIONAL ACCESSORIES

- 500mm Corner piece (250 + 250mm arms, bend to desired angle)
- Hard surface fixing bracket
- Heavy duty peg



100mm Rigid Installation Guide

Scan or click to watch install video

▶ INSTALL GUIDE



REQUIRED FIXINGS

- 2 x Tek Screws (12G x 16mm) or
- 2 x pop rivets (4mm shaft)

RECOMMENDED TOOLS

- Ground leveling tools
- Rubber mallet
- Cordless drill and Tek screw bit
- Angle grinder (only required if modifying lengths or fashioning ends)

PREPARATIONS

Mark the intended line on the ground and measure what length of edge is needed. Making a trench to set the edge into may be necessary. This will dictate the amount of edge that finishes proud and visible for your buried edge. For a retrofit, where surrounding heights are set, trench relative to these. For a new garden where surrounding materials may be added, the edge is sometimes installed without a trench, and then materials are filled up to and around it. Either way, burying the edge more deeply adds strength and assists curve support. Consider the 150mm or 240mm edge if more visibility of edge face is desired.

Note: This edge will allow slight curving. Corners can be made in situ or purchased as accessories.

DO...

- ✓ Use for straight lines or very slight curves
- ✓ Consider the best edge orientation in terms of smooth face/top edge viewing
- ✓ Take care to position pegs exactly in line
- ✓ Use some Flex lengths if your design has some curved sections, they're compatible!

DON'T...

- ✗ Use for tight curving lines, instead use Flex edge
- ✗ Forcibly bend. This Rigid edge will shape gently for a slight curve only
- ✗ Accelerate rust with acids or salts, that's harmful to patina development

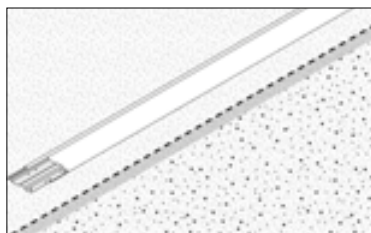

STEP 1 - Mark edge line on ground or by trenching and layout edge pieces.

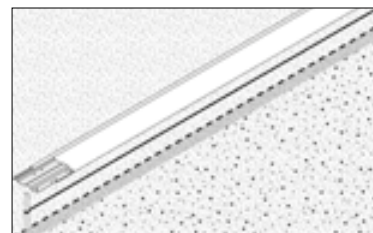

STEP 2 - Be sure trench depth is right and set string line, laser or other method to mark line.

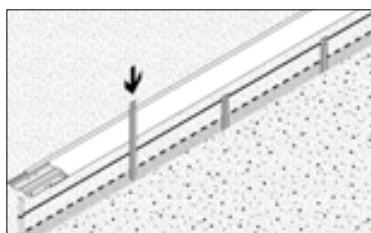

STEP 3 - Evenly space and hammer in pegs (three per length) directly along line to just above finishing height.

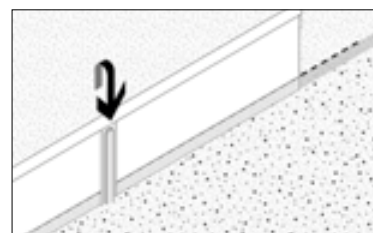

STEP 4 - Place first edge onto first three pegs (start at edge end without a connector plate).

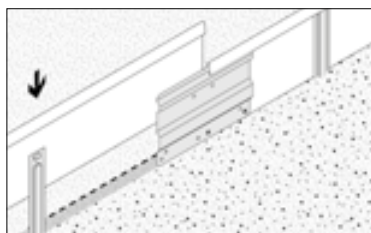

STEP 5 - Place next edge down onto pegs and connector plate of first edge for joining.

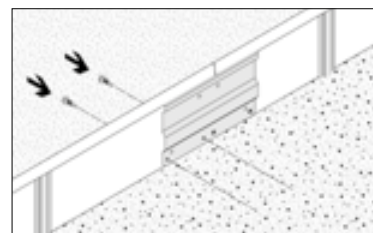

STEP 6 - Align guide holes for snug join, Secure with tek screws.

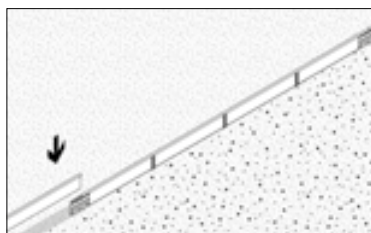

STEP 7 - Introduce further lengths, connecting them as you go along the install line.

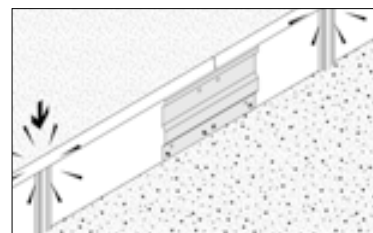

STEP 8 - Once all are in place, use rubber mallet to firmly strike edge so pegs lock in.

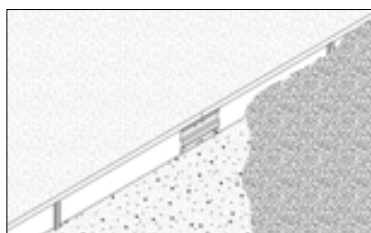

STEP 9 - Then backfill to finish, packing fill around the edge.

CORNERS

Standard corners are available for purchase, but you can choose to make your own. Making your own corners will likely mean less waste, as the corners are simply made where they are needed with no offcuts created.

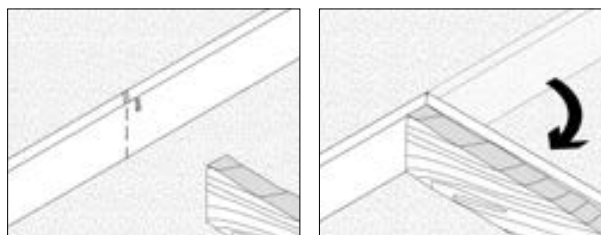

STEP 1 - Score a line down the back of the edge and create a sufficient opening (5-7mm) in the double folded lip at the top.

STEP 2 - Bend by hand. Placing a block of wood close to the fold improves the result.

GEOMETRIC SHAPES

You may look to create the likes of rectangles or squares such as for tree surrounds. To do so measure carefully and create the corners where needed. Alternatively purchase four corners for an exact 500mm square shape.

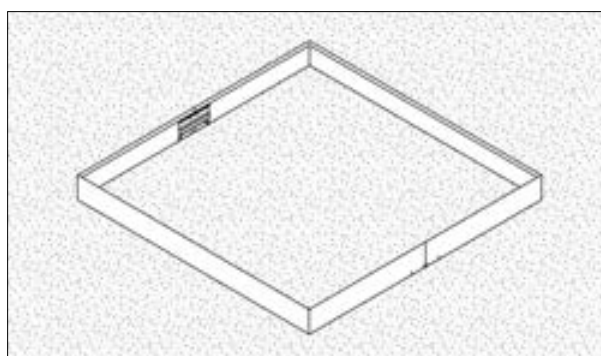

INSTALLING ON HARD SURFACES

Where ground conditions are too hard for standard pegs to penetrate, the heavy duty peg may be used instead. These are first driven into the ground (hammer the hip, not the top part) and then the edge is hammered onto them with a rubber mallet to firmly wedge the heavy duty peg in under the edge rim.

Alternatively the Hard Surface Fixing Bracket may be used. This also wedges firmly in under the edge rim when the edge is hammered onto it with a rubber mallet. This Hard Surface Fixing bracket can be secured through the holes in the foot with galvanised spikes in hard ground or with DynaBolts™ when fixing to concrete. The DynaBolts™ or Fixing spikes utilised do not come with the bracket so need to be acquired separately.

On impermeable surfaces such as concrete, use packers to elevate the edge slightly; allowing drainage away from edge.

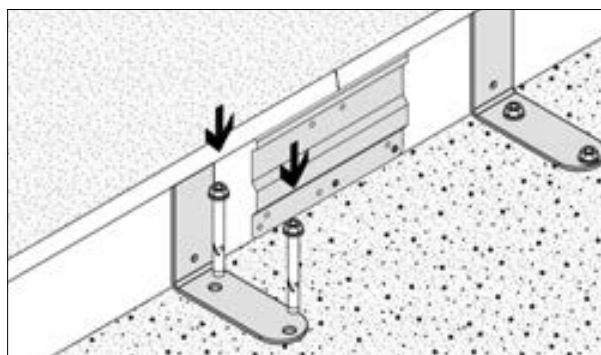
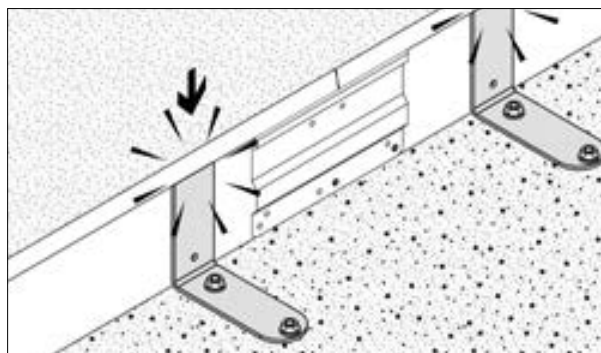

JOINING EDGE TO A SURFACE OR ROCK

A join tab can be made using an angle grinder. This involves cutting away the top lip portion and scoring a fragmented fold line for the remaining tab piece. The tab is then bent as required for fixing and screwing to the surface it joins.

If butting up to a rock, using a diamond tip blade to cut a slot in the rock itself allows the edge to sit into it snugly, or just use the rock to hide the edge end safely behind it.

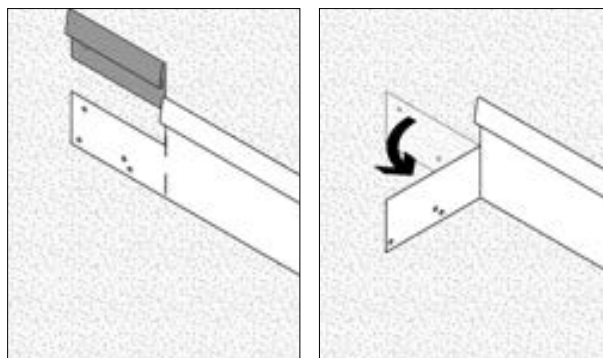

COMPATIBILITY

The 150mm Rigid is compatible with the 150mm Flex, because the joining plates and edge profile are exactly the same. This means you can use both together on the same project!

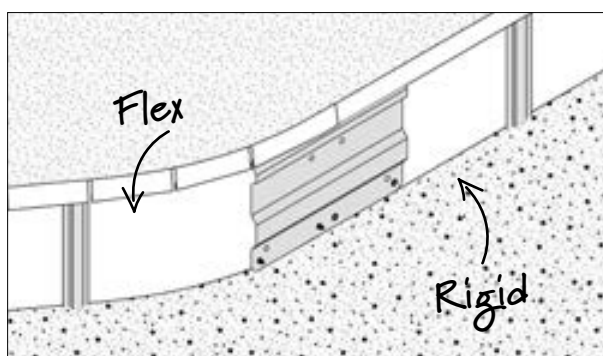

Straightcurve® Zero-Flex Garden Edging - 100mm

HL100WS WEATHERING STEEL | HL100GS GALVANISED STEEL

Product features

The details that make the difference

Connector plate and guide holes for precise and discreet joins



Two-way Continuous Foot for holding straight lines



Double wall and rolled top for structural strength



7mm rounded tops for child and pet safety



Moveable fixing spikes for easy obstacle avoidance



EDGE STYLE



FINISHES

- Galvanised Steel
- Weathering Steel

For lasting, perfectly straight unmovable lines

Product specifications

TECHNICAL SPECIFICATIONS

Length (Installed)	2200mm
Top edge thickness	7mm
Steel plate thickness	1.6mm
Weight per length	6.4kg

BULK BUYING

Pack quantity	22
Bulk pack weight inc. pallet	160kg

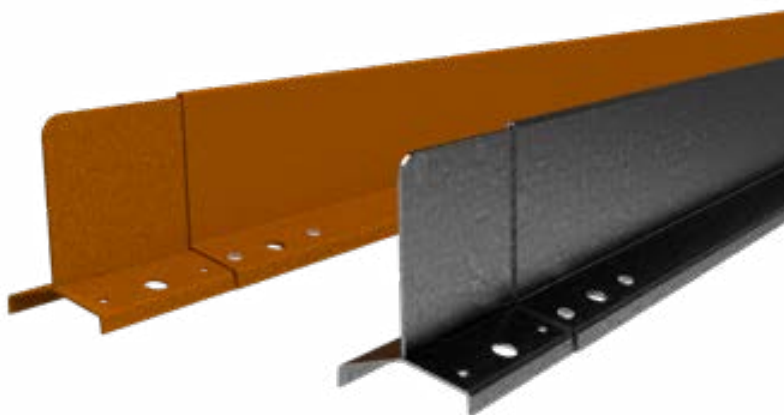

SOLD AS SET INCLUDING

- 1 x Connector plate (pre-attached)
- 4 x Galvanised spikes, 300mm long



ADDITIONAL ACCESSORIES

- 500mm (250mm + 250mm) Corner piece (reversible) (bend to desired angle)

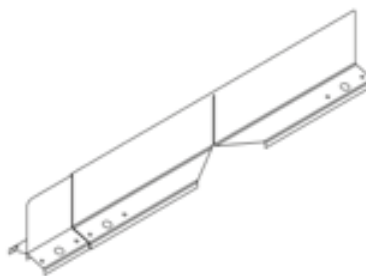

100mm Zero-Flex Installation Guide

Scan or click to watch install video

▶ INSTALL GUIDE

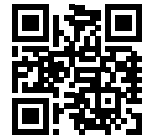

REQUIRED FIXINGS

- 4 x Tek Screws (12G x 16mm) or
- 4 x pop rivets (4mm shaft)

RECOMMENDED TOOLS

- Ground leveling tools
- Rubber mallet
- Cordless drill and Tek screw bit
- Angle grinder (only required if modifying lengths or fashioning ends)

PREPARATIONS

Mark the intended line on the ground to measure what length of edge is needed.

A firmer, compacted base is best for installing Zero-Flex and may need to be prepared first. This foundation is key for the edges strength and line holding capability.

For a retrofit, where surrounding heights are set, trench relative to these. For a new garden where surrounding materials may be added, the edge is sometimes installed without a trench, and then materials are filled up to and around it. The trench depth dictates the amount of edge that finishes proud and visible. Burying the edge more deeply adds strength, as does having firm flat ground as the foundation. Consider the 150mm Zero-Flex if more visibility of edge face is desired.

DO...

- ✓ Pay attention to best ground preparation for a firm foundation
- ✓ Get the depth of trench right the first time
- ✓ Join all lengths and corners in place and perfect the line before finally fixing in position

DON'T...

- ✗ Use all galvanised spikes on one side only
- ✗ Skip the screwing stage, these lock in the seamless join
- ✗ Accelerate rust with acids or salts, that's harmful to patina development
- ✗ Leave a square top corner unsafely protruding at an end, cap or round it off with a grinder instead.

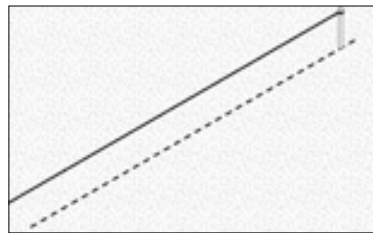

STEP 1 - Use string line or mark edge line on a firm base.

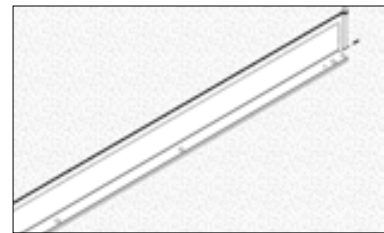

STEP 2 - Position first edges along the desired line.

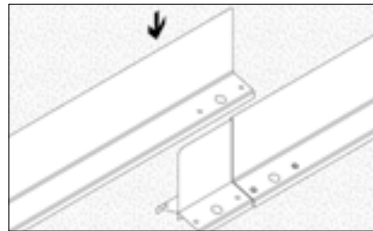

STEP 3 - Slide connector plate of one edge into the next to connect.

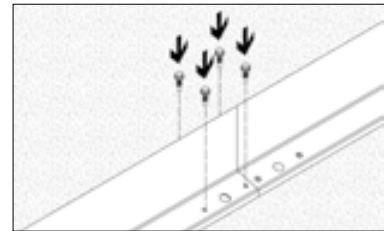

STEP 4 - Secure together with Tek screw through aligned guide holes.

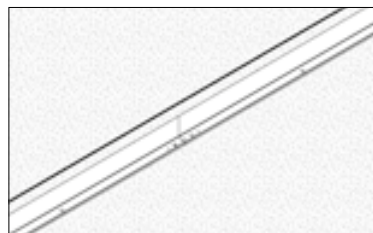

STEP 5 - Introduce further lengths, connecting them as you go along the install line.

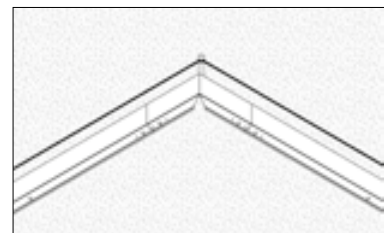

STEP 6 - Form and introduce corners where needed (lengths may need to be cut with grinder).

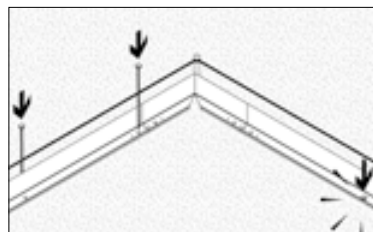

STEP 7 - Check position then hammer four galvanised spikes per length through foot holes, either side and evenly spaced.

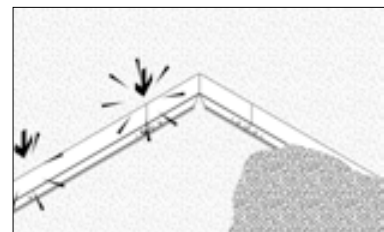

STEP 8 - Firming can be done with the rubber mallet, then backfill to finish

Bonus Tip! When is adding concrete footings a good idea?

For a Zero-Flex install on soft/sandy/shifting ground conditions consider setting the galvanised fixing spikes and the join sections into some concrete. Fill materials on both sides also add strength and can remove the need for concrete, but the foundation the edge sits on is always key to Zero-Flex's strength.

CORNERS

Standard corners are available for purchase, and their direction can be reversed when required by moving the connector plate to the other arm. Alternatively, you can choose to make your own corners. Making your own corners will likely mean less waste, as the corners are simply made where they are needed with no offcuts created.

Suggestion: Purchase one corner, and use that as a template for cutting in corners in other whole lengths where needed.

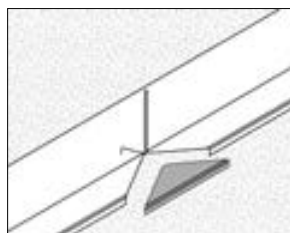

STEP 1 - Cut down the vertical wall (not to the very top) and cut away a V in the shoulder foot (at least 120 degrees) on the side where you will bend it in.

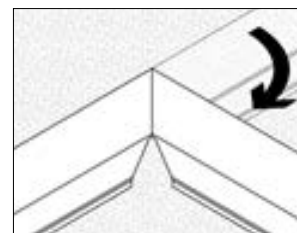

STEP 2 - Make a single cut on the opposing side shoulder (see step 1 diagram) then bend in the corner.

RECTANGLES & SQUARES

To create rectangles or squares be precise with your marking out before cutting. It's possible to join four corner pieces to easily make a 500mm x 500mm square. Similarly corners could be utilised with full lengths or part thereof, to make larger square or rectangular beds.

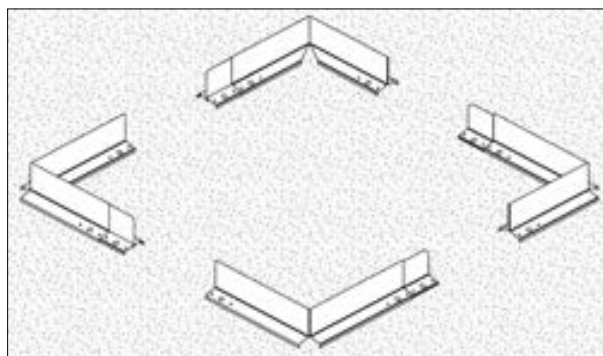

INSTALLING ON HARD SURFACES

The edge can be installed on a hard surface. When the surface is very hard but penetrable, use the galvanised spikes supplied. If the surface is impenetrable, such as with concrete, a bolt down approach (purchase separately) can be applied. Utilise the same fixing holes but use packers to raise the edge slightly to allow drainage away from the edge.

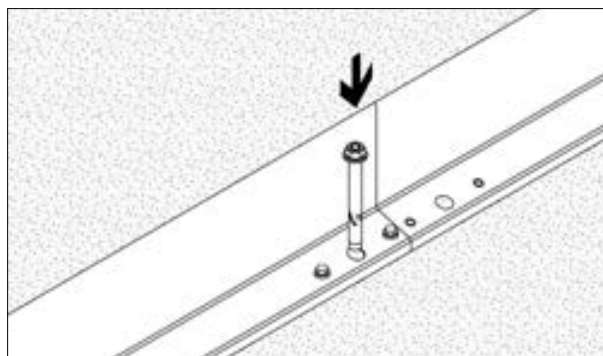

COMPATIBILITY

The Zero-Flex can have the equivalent height Flex product connected to it if a curved section is required. The top profiles are not exactly the same, but very similar when butted together. The Flex connector plate will slot into the Zero-Flex and would then need custom securing down low with some Tek screws.

Where the non-connector plate end of the flexline meets Zero-Flex Garden Edging (see adjacent pics), cut out a lower portion of the Flex edge to allow it to sit neatly onto the Zero-Flex edge connector plate and secure with screws.

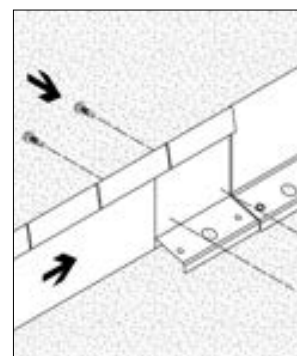
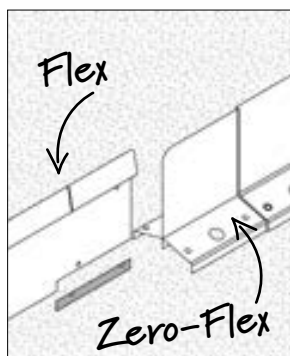

Technical Drawings

75mm

100mm

150mm

240mm

400mm

560mm

Planter boxes

STRAIGHTCURVE® FLEX GARDEN EDGING - 100MM

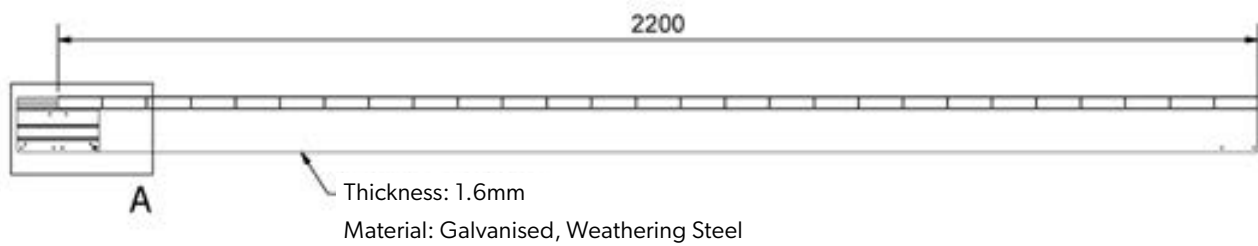

STRAIGHTCURVE® RIGID GARDEN EDGING - 100MM

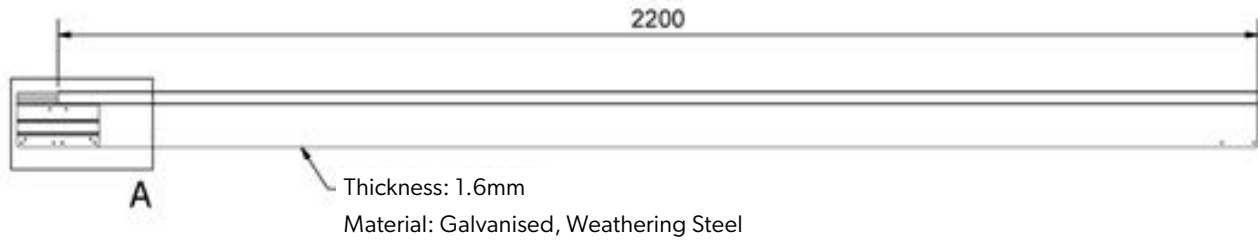

UNIVERSAL SPECIFICATIONS

SIDE PROFILE

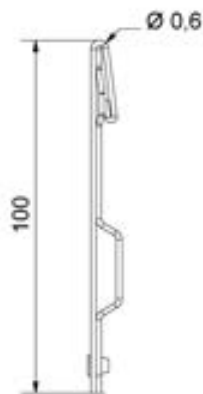

CONNECTOR PLATE

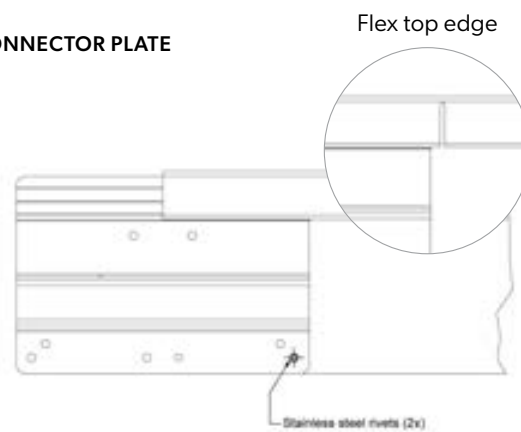

HARD SURFACE FIXING BRACKET

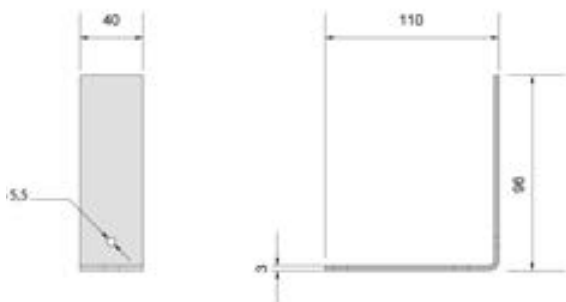

HEAVY DUTY PEG

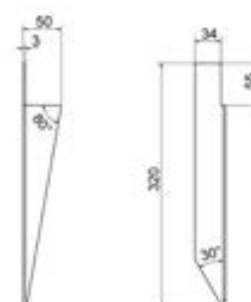



75mm

100mm

150mm

240mm

400mm

560mm

Planter boxes

STRAIGHTCURVE® ZERO-FLEX GARDEN EDGING - 100MM

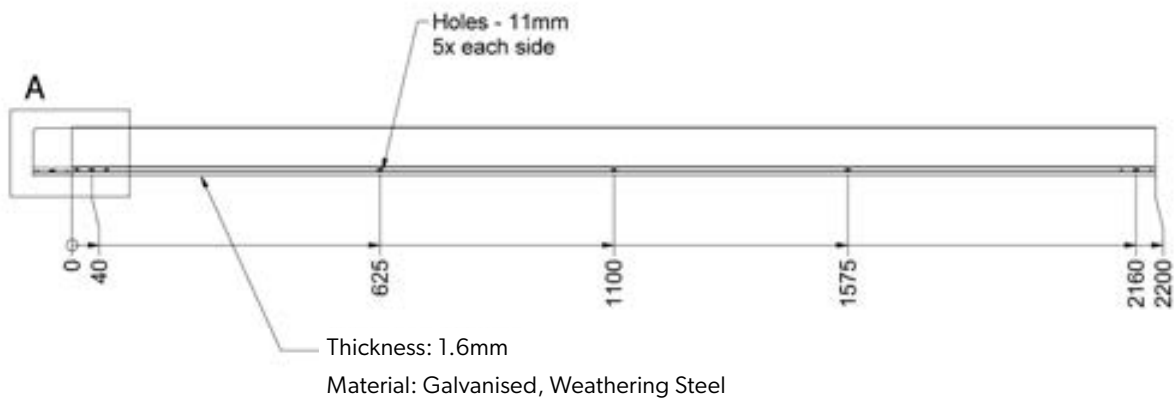

SIDE PROFILE



CONNECTOR PLATE

