

straightcurve®

Product catalogue

- Product specifications
- Installation advice
- FAQs & more



www.straightcurve.com

Simply Better

Contents

SECTION 1: PRODUCT GUIDE

Straightcurve® Garden Edging

75MM HEIGHT

- ⊕ Flex Garden Edging - 75mm
- ⊕ Zero-Flex Garden Edging - 75mm

100MM HEIGHT

- ⊕ Flex Garden Edging - 100mm
- ⊕ Rigid Garden Edging - 100mm
- ⊕ Zero-Flex Garden Edging - 100mm

150MM HEIGHT

- ⊕ Flex Garden Edging - 150mm
- ⊕ Rigid Garden Edging - 150mm
- ⊕ Zero-Flex Garden Edging - 150mm

Straightcurve® Raised Garden Beds

240MM HEIGHT

- ⊕ Flex Raised Garden Beds - 240mm
- ⊕ Rigid Raised Garden Beds - 240mm
- ⊕ Zero-Flex Raised Garden Beds - 240mm AVAILABLE SOON

400MM HEIGHT

- ⊕ Flex Raised Garden Beds - 400mm
- ⊕ Rigid Raised Garden Beds - 400mm
- ⊕ Zero-Flex Raised Garden Beds - 400mm

560MM HEIGHT

- ⊕ Flex Raised Garden Beds - 560mm
- ⊕ Rigid Raised Garden Beds - 560mm
- ⊕ Zero-Flex Raised Garden Beds - 560mm

Straightcurve® Planter Boxes

- ⊕ Planter Boxes - 400mm
- ⊕ Planter Boxes - 560mm

SECTION 2: KNOWLEDGE BUILDER

FAQs

1. How quickly does the weathering steel change colour & how long will it last?

UNDER DEVELOPMENT

More coming soon...

SECTION 3: STRAIGHTCURVE® TERMINOLOGY

Key terms and their descriptions

This section will keep you up to date with our lingo and helps us all to be on the same page. If you find yourself lost for words, check these sheets for the latest Straightcurve® terminology, key terms and their descriptions.

Section 1:

Product Guide



75mm Garden Edging

For curved and straight edging situations.

Do you know what edging product is best for your project? Let's figure that out together here!

Firstly, what are you trying to do?



LAWN EDGE

Non-invasive grasses and ground covers

OR



PATHWAYS/RETAINING

Paving, stone and crush retainer edge

OR



DIVIDER

Divider between gravels/ woodchips/ mulches etc

Perhaps it looks something like these?

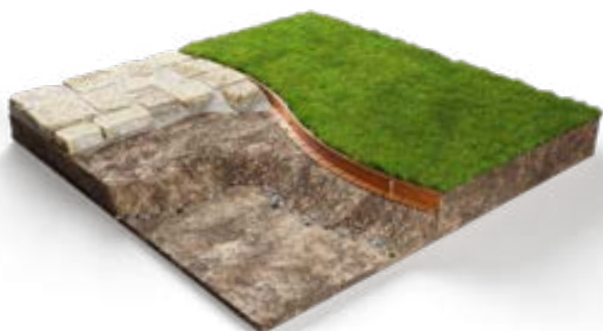

Straightcurve® Flex Garden Edging - 75mm

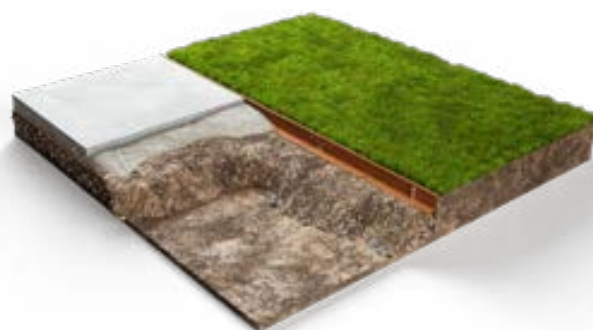

Straightcurve® Zero-Flex Garden Edging - 75mm

How do you choose from our two 75mm edging options?

We have a 75mm edge for curved or straight edging situations. Consider what matters to you so you can be sure of selecting the best option from our range. It's your call and we hope this selection table makes it easier!

I'm looking for...

We recommend for this ...

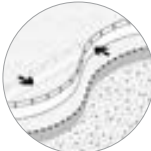
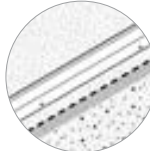
	 Flex - 75	 Zero Flex - 75
Something I can do myself	✓	✓
Something flexible enough to make tight curves with ease	✓	✗
Tree rings	✓	✗
Tree box surrounds	✗	✓
Something with no flex that helps me to create a straight run	✗	✓
A straight edge that will stay true and won't waver*	✗	✓
An edge ideally suited to run pavers up to, instead of a concrete haunch	✓	✓

*Preparation of a level compacted surface gives the best result, but this edge is vulnerable to forceful impacts. The Zero-Flex 100mm is a stronger option.

Did you know? It's also possible to combine styles, as our Flex Garden Edging and Zero-Flex Garden Edging are join and profile compatible.

Product overview

ROUNDED TOPS AND SAFETY FEATURES

The smooth, rolled tops and rounded connector plate corners assist safe handling. When installed, all joins/fixings are internal so that the exposed top and front present as a smooth top edge and continuous fascia.

SAFER AND CLEANER HANDLING

We recommend wearing gloves as the manufacturing process can leave residual oils/dust and our products can get hot when exposed to sunlight. Our products are shipped in bundles, when lifting bundles handlers should be mindful of their carrying capabilities. Single items are easy to carry for one person (see product weights).

ABOUT WEATHERING STEEL

The manufacturing process of weathering steel leaves the surface in a dark, almost black state. This dark 'finish' is an oxide layer that forms during the hot rolling process. The weathering process needs to break this layer down first before the desired protective patina layer can be established. You can expect some inconsistency in the patina formation because the thickness of the oxide layer varies; it'll appear spotty with some areas going orange and others still black.

The patina develops naturally with periods of wet and dry, and both phases are key for its steady formation. Do not wet continually without allowing time for thorough drying. A faster patina formation can be aided by cleaning the surface with soapy water to remove oil residue, but anything harsher is not advised as it can be detrimental to patina development and consequently, reduce product lifespan. Some rust solution products are safe to use as these 'build a surface patina' rather than just accelerating rusting.

WHAT IS A PATINA?

Patina is not the same as rust. All rust is patina, but not all patina is rust. Patina is a chemical bond between various elements and usually oxygen. It can be found on most metals with the exception of 8 inert (noble) metals like gold or silver. 'Normal' rust is iron-oxide, the patina referred to above is mostly a bond between copper, phosphorus, chromium, nickel, iron and oxygen. You may wonder, how does water feature in it? Water acts as an electrolyte, but that's a different story. In the end, the patina formed on

weathering steel is a dense layer that doesn't flake or allow oxygen through. Therefore, once formed, the oxidation process slows down dramatically.

LONGEVITY

Our products are of the highest quality ensuring longevity in the given environment. For further information please refer to the "Longevity Guide" and "Product Care Guide" on our website.

PAINTING, SEALING AND POWDERCOATING

Our galvanised products are suited to painting, but the surface should be thoroughly prepared (using acetone wash), and sealed with a metal primer (etch primer is very good) to maximise topcoat adhesion.

Powdercoating is a much more durable/hardy choice, and can be requested for large projects with lead times/costings supplied. It is worth noting that not all powdercoating performs the same, we use and recommend Interpon powder from AkzoNobel for assured quality and maximum endurance and suggest you request the same. It's also worth asking first to see a sample from your chosen powdercoater specialist.

Another question we get relates to freezing the colour (or patina development) at a certain stage. That's possible using a transparent sealant suitable for steel. Keep in mind that the colour will change when applying a sealant, it'll get a 'wet' look. Be sure to test this in a small inconspicuous area first before fully committing. This will require reapplication once a year.

WHEN IS CONCRETING AROUND THE FIXING SPIKES NECESSARY?

For sandy/soft/shifting ground conditions, consider setting the galvanised spikes into a small amount (3-5L) of concrete for extra hold. This is rarely required though, as the fill method tends to provide sufficient support for the buried edge and the 75mm edge is not performing a considerable load bearing function like taller profiles often do. Wetting down the sandy area prior improves stability during installation.

HOW TO POSITION THE EDGE?

This product has a back and a front facing side. Please consider which side will be the most visible in situ, based on your garden design and likely use of the area. This edge has a foot which is often used on the hard materials side (pavers/stone/crush) as their downward pressure increases edge rigidity with the hard materials built up to the top of the edge.

Fills such as mulch and stone may settle at lower than the install level and so require topping up later to maintain the look initially achieved. This top up practice can also increase lifespan, as the protective patina formation may be inconsistent in previously buried portions.

HOW DEEP DO I BURY THE EDGE?

This edge is designed to be mostly buried both in terms of the aesthetic finish and to maximise it's strength and durability. You may choose to leave the top portion (around 2cm) of the edge proud to help with material separation and containment, or for lawn maintenance practices of strimming against the edge itself. Not burying the edge at all will leave join systems visible and see the edge vulnerable to damage.

WHY DO WE SUPPLY AND RECOMMEND TEK SCREWS?

You will see the pre-attached connector plate is fixed to the edge with rivets. This is the best method in the factory but when installing our edging Tek screws are a faster, stronger and easier option.

The long lasting, grey Dacromet® Tek screws are best for all buried screw locations. With a weathering steel install, and on the rare occasions when the screws are visible the zinc colour Tek screws are used as they rust over, making them less aesthetically intrusive.

However, if you choose to use rivets be sure to use stainless steel and not aluminium which will disappear within a year or so. Aluminium, like zinc, is a sacrificial anode that protects the steel by sacrificing itself.

ADVANTAGES

- ✓ Continuous smooth rolled tops
- ✓ Free standing for shape adjustment
- ✓ Strong, penetrative fixing spikes
- ✓ No welding required
- ✓ Up to 3x faster installation
- ✓ Designed for ease of use

Straightcurve® Flex Garden Edging - 75mm

FL075WS WEATHERING STEEL | FL075GS GALVANISED STEEL

Product features

The details that make the difference

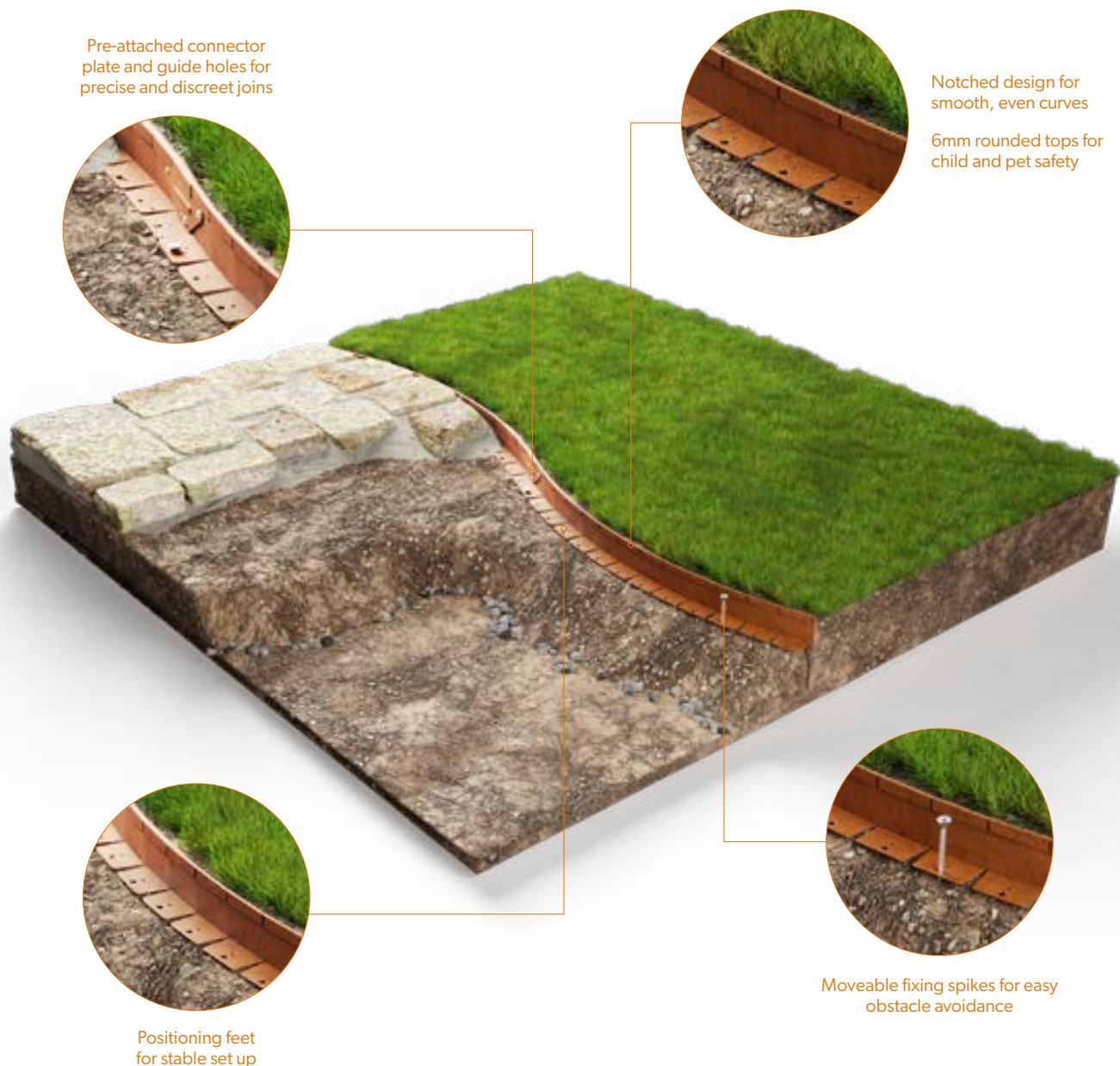

Pre-attached connector plate and guide holes for precise and discreet joints

Notched design for smooth, even curves

6mm rounded tops for child and pet safety

Moveable fixing spikes for easy obstacle avoidance

Positioning feet for stable set up

EDGE STYLE



For smoothly curving edging applications that hold position once shaped and installed.

FINISHES

- Galvanised Steel
- Weathering Steel

Product specifications

TECHNICAL SPECIFICATIONS

Length (Installed)	2200mm
Top edge thickness	6mm
Steel plate thickness	1.6mm
Weight per length	3.7kg

BULK BUYING

Pack quantity	70
Bulk pack weight inc. pallet	280kg

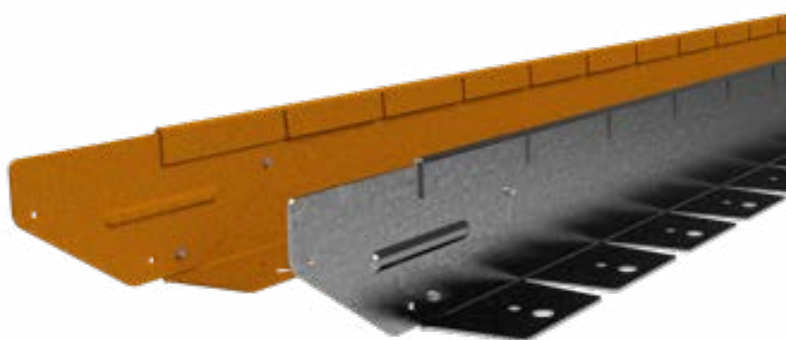

SOLD AS SET INCLUDING

- 1 x Connector plate (pre-attached)
- 3 x Galvanised spikes, 300mm long

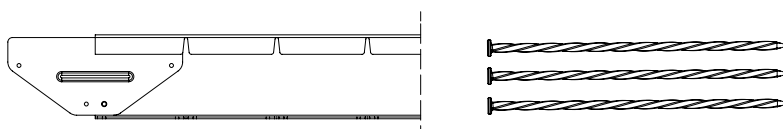

75mm Flex Installation Guide

Scan or click to watch install video



REQUIRED FIXINGS

- 2 x Tek Screws (12G x 16mm) or
- 2 x pop rivets (4mm shaft)

RECOMMENDED TOOLS

- Ground leveling tools
- Rubber mallet
- Cordless drill and Tek screw bit
- Angle grinder (required if modifying lengths or fashioning corners/ends)

PREPARATIONS

Mark the intended line on the ground. You might lay out a garden hose or try line marking paint if this helps visualise the design. Measure the length of edge needed.

For a lower finishing height, make a trench to sit the edge into. A firm level base is easier to work on, so if working on loose sand wet the area down first.

Note: This edge allows gentle sloping and corners are simply bent in.

DO...

- ✔ Consider the best edge orientation in terms of smooth face viewing.
- ✔ Join all lengths in place and perfect the line before fixing in final position.
- ✔ Use some spikes to hold partially in place while reviewing position.
- ✔ Flex rather than bend, especially if creating rings.
- ✔ Use some 75mm Zero-Flex lengths if your design has some straight sections, they're compatible!

DON'T...

- ✘ Use for straight lines, instead use 75mm Zero-Flex.
- ✘ Forcibly bend. Take care and gently flex the edge to shape.
- ✘ Accelerate rust with acids or salts.
- ✘ Leave a square top corner unsafely protruding at an end, cap or round it off with a grinder instead.

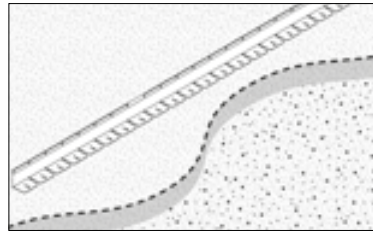

STEP 1 - Mark out edge line, prepare ground and place edges nearby.

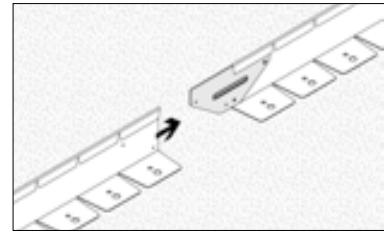

STEP 2 - Slide connector plate of one edge into the next to connect.

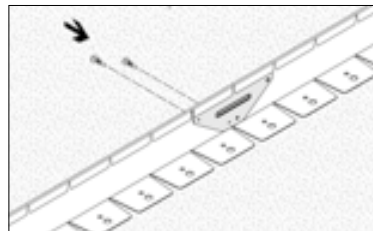

STEP 3 - Secure together with Tek screws through aligned guide holes.

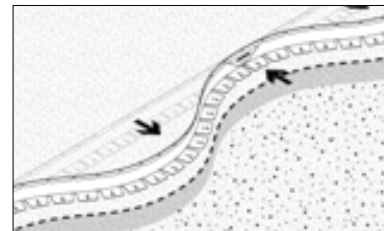

STEP 4 - Introduce further lengths, flex to shape and join as you go.

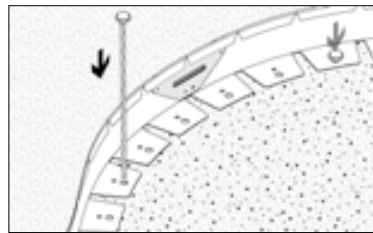

STEP 5 - Fix edge foot tabs with twisted nails in desired position.

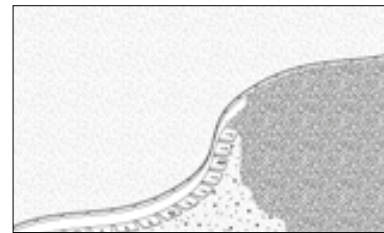

STEP 6 - Backfill to finish.

CORNERS - Corners are easily bent in by hand and with use of a rubber mallet. First raise up the foot tab adjacent the bend point so it's out of the way. Then bend in the corner and finish shaping with a rubber mallet.

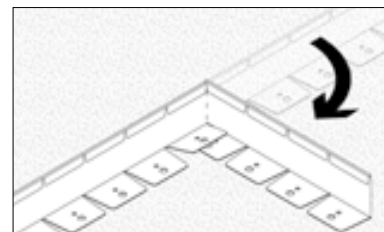
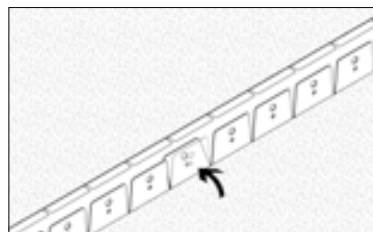

CIRCLES AND TIGHT CURVES

One length makes a tight 70cm diameter circle. Take care to gently flex the edge (i.e. do not bend) when forming the ring. Once the connector plate is aligned, Tek screw through the guide holes, then carefully adjust ring shape to your liking and fix to ground. Use a rubber mallet for making subtle shape adjustments.

The tight ring made with one length is not completely smooth on the inside. You can add part of a length (which requires cutting) to get a smoother result. Using whole lengths only the diameters increase with each additional length, i.e. 141cm, 212cm, 283cm and so on. As a guide the tightest curves without kinking the steel is equivalent to a radius of around 35cm.

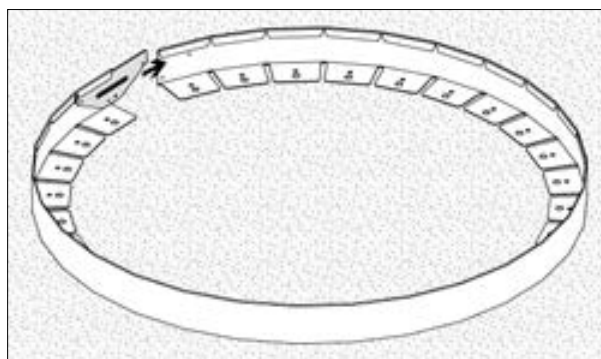

INSTALLING ON HARD SURFACES

The galvanised spikes will penetrate very hard ground, but use a bolt down option (galvanised bolts) for concrete or other impenetrable surfaces. On impermeable surfaces use packers to elevate the edge slightly; allowing drainage away from edge.

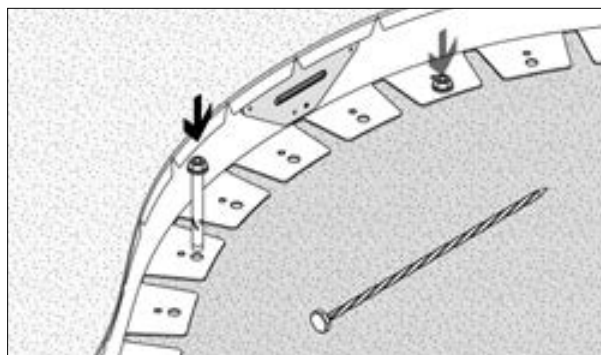

COMPATIBILITY

The 75mm Flex is compatible with the 75mm Zero-Flex, because the joining plates and edge profile are exactly the same. Where a layout requires curved sections and straight sections order some of each to best meet the design plan.

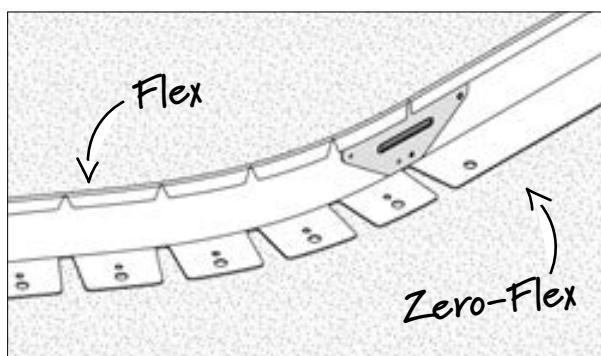

Straightcurve® Zero-Flex Garden Edging - 75mm

RL075WS WEATHERING STEEL | RL075GS GALVANISED STEEL

Product features

The details that make the difference

Pre attached connector plate and guide holes for precise and discreet joins

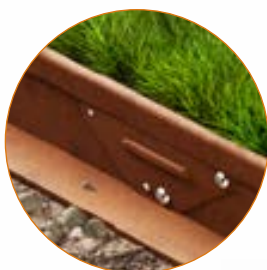

6mm rounded tops for child and pet safety



Continuous rolled top teams with angled foot for more rigid lines



Positioning feet for stable set up

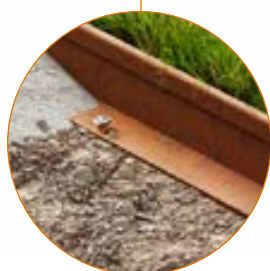

Moveable fixing spikes for easy obstacle avoidance



EDGE STYLE**FINISHES**

- Galvanised Steel
- Weathering Steel

For creating straight lines that look good down the line.

Product specifications

TECHNICAL SPECIFICATIONS

Length (Installed)	2200mm
Top edge thickness	6mm
Steel plate thickness	1.6mm
Weight per length	3.7kg

BULK BUYING

Pack quantity	70
Bulk pack weight inc. pallet	280kg

**SOLD AS SET INCLUDING**

- 1 x Connector plate (pre-attached)
- 3 x Galvanised spikes, 300mm long

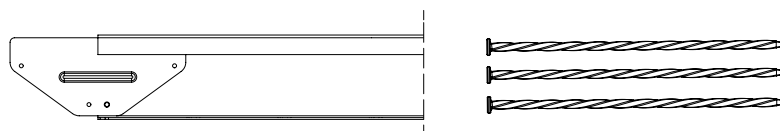
**ADDITIONAL ACCESSORIES**

- 500mm Corner piece (250 + 250mm arms, bend to desired angle)

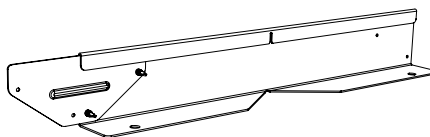

75mm Zero-Flex Installation Guide

Scan or click to watch install video



REQUIRED FIXINGS

- 2 x Tek Screws (12G x 16mm) or
- 2 x pop rivets (4mm shaft)

RECOMMENDED TOOLS

- Ground leveling tools
- Rubber mallet
- Cordless drill and Tek screw bit
- String line/line marking aid
- Angle grinder (required if modifying lengths or fashioning ends)

PREPARATIONS

Mark the intended line on the ground to measure what length of edge is needed. For a lower finishing height, make a shallow trench to partially bury the edge. A firm, level base is easier to work on, so if working on loose sand, wet down first. With the surface ready a string line or similar aid is useful to assist edge placement.

Note: This edge will not flex for gentle curves, it is for straight lines only.

DO...

- ✔ Consider the best edge orientation in terms of smooth face viewing.
- ✔ Ensure the install surface is levelled before installing.
- ✔ Join all lengths in place and check the line before finally fixing in position.
- ✔ Introduce or make corners where needed for a continuous top edge line.
- ✔ Use some spikes to hold partially in place while reviewing position.
- ✔ Use some 75mm Flex lengths if your design has some curved sections, they're compatible!

DON'T...

- ✘ Try to bend, instead use 75mm Flex for any curved sections.
- ✘ Accelerate rust with acids or salts.
- ✘ Leave a square top corner unsafely protruding at an end, cap or round it off with a grinder instead.

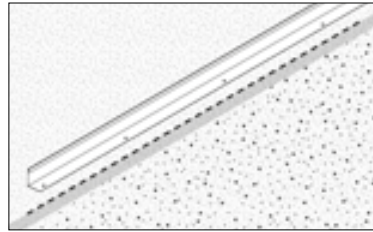

STEP 1 - Mark out edge line on ground and position edges on the desired line.

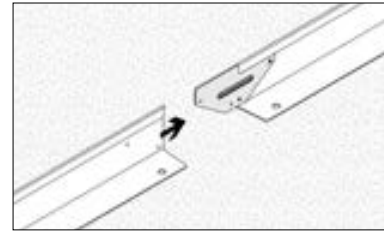

STEP 2 - Slide connector plate of one edge into the next to connect.

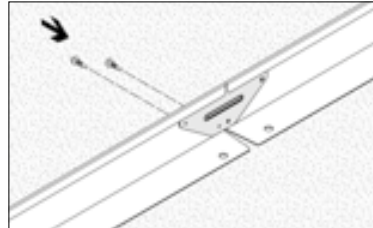

STEP 3 - Secure together with Tek screw through aligned guide holes.

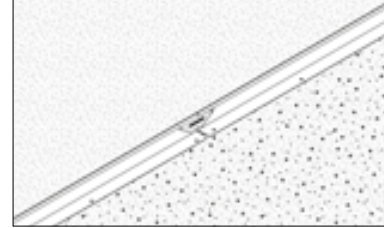

STEP 4 - Introduce further lengths, connecting them as you go.

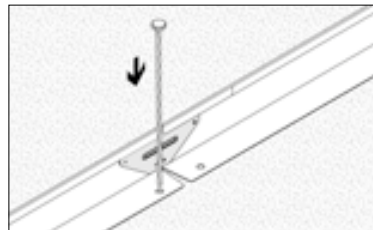

STEP 5 - Fix edge foot tabs with twisted nails in desired position.

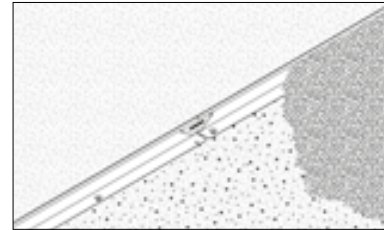

STEP 6 - Backfill to finish.

CORNERS - Corners are available for purchase or you can choose to make your own. Making your own corners will likely mean less waste, as the corners are simply made where they are needed with no offcuts created.

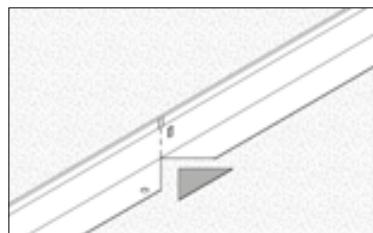

STEP 1 - Use angle grinder to score a line down the back of the edge and cut out these required gaps

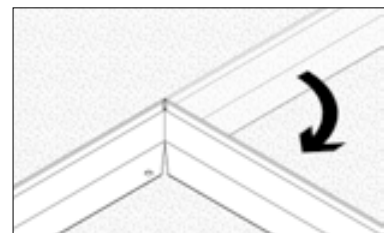

STEP 2 - Bend by hand (past the 90 then back for right angles) and perfect shape with rubber mallet.

i) 5-7mm of the folded lip at the top; and

ii) A wide triangular piece from foot (angle exceeding 90 degree)

GEOMETRIC SHAPES

You may look to create the likes of rectangles, squares or other linear shapes and patterns. To do so measure carefully and create the corners where needed.

When making basic corners, creating a foot gap larger than the space required allows you to bend past and return to the 90 degree angle which is helpful in getting it 'just right.'

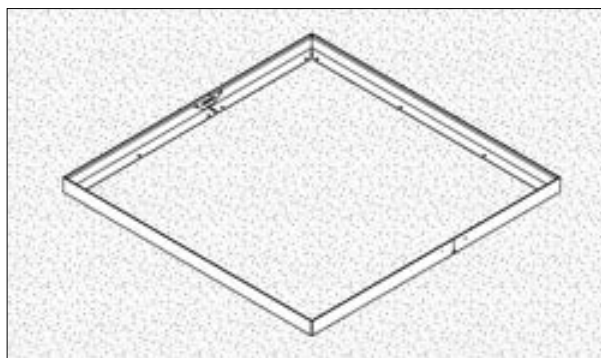

INSTALLING ON HARD SURFACES

The galvanised spikes will penetrate very hard ground, but use a bolt down option for concrete or other impenetrable surfaces. On impermeable surfaces use packers to elevate the edge slightly; allowing drainage away from edge.

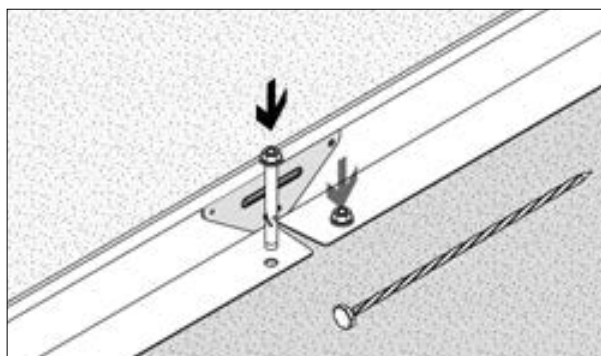

COMPATIBILITY

The 75mm Zero-Flex is compatible with the 75mm Flex, because the joining plates and edge profile are exactly the same. Where a layout requires straight sections and curved sections order some of each to best meet the design plan.

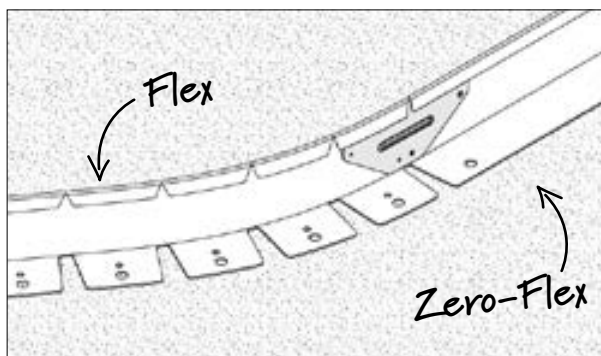

Technical Drawings

STRAIGHTCURVE® FLEX GARDEN EDGING - 75MM

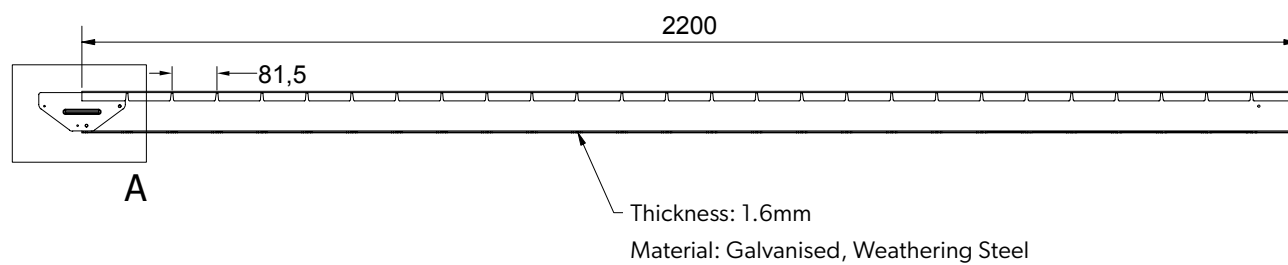

STRAIGHTCURVE® ZERO-FLEX GARDEN EDGING - 75MM

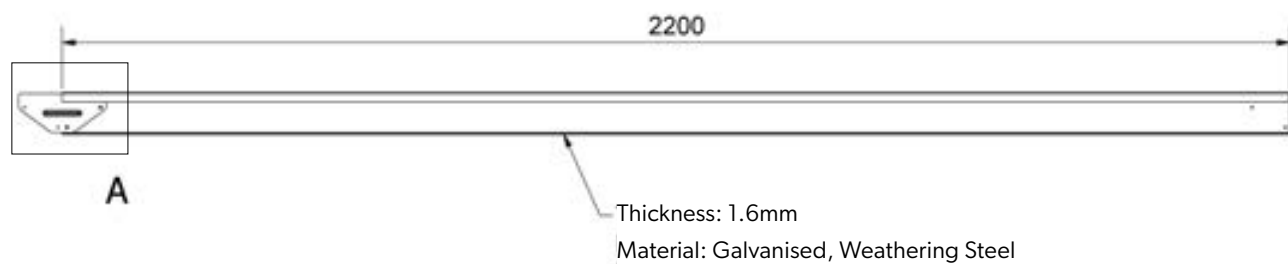



75mm

100mm

150mm

240mm

400mm

560mm

Planter boxes

SIDE PROFILE



CONNECTOR PLATE

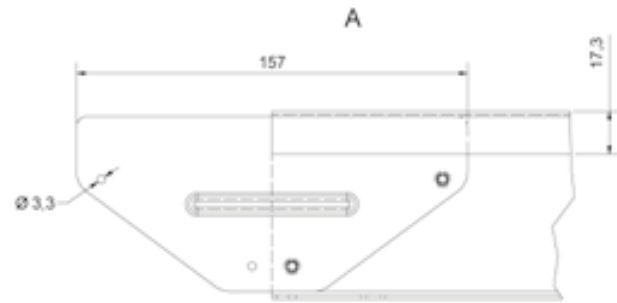

STRAIGHTCURVE® ZERO-FLEX GARDEN EDGING - 75MM - CORNER

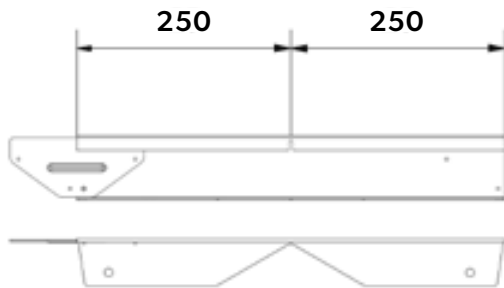

100mm Garden Edging

For curved and straight edging situations.

Do you know what edging product is best for your project? Let's figure that out together here!

Firstly, what are you trying to do?



LAWN EDGE

Lawn edge for non-invasive grasses and ground covers

OR



PATHWAYS/RETAINING

Paving, stone and crush retainer edge

OR



DIVIDER

Divider between gravels/ woodchips/ mulches etc

Perhaps it looks something like these?



Straightcurve® Flex Garden Edging - 100mm



Straightcurve® Zero-Flex Garden Edging - 100mm

How do you choose from our three 100mm edging options?

We have solutions for curved and straight edging situations. Consider what matters to you so you can be sure of selecting the best option from our range. It's your call and we hope this selection table makes it easier!

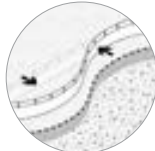
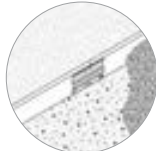
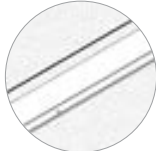
I'm looking for...	We recommend for this ...		
	 Flex - 100	 Rigid - 100	 Zero-Flex - 100
Something I can do myself	✓	✓	✓
Something flexible enough to make tight curves with ease	✓	✗	✗
Tree rings	✓	✗	✗
An edge that creates a strong gentle curve, for a radius exceeding 4m	✗	✓	✗
Something rigid that helps me to create a straight run	✗	✓	✓
A straight edge that will stay true and won't waver	✗	✗	✓
An edge ideally suited to run pavers up to, instead of a concrete haunch	✗	✗	✓

Did you know? It's also possible to combine styles, as our Flex Garden Edging and Rigid Garden Edging are join and profile compatible. Flex edging can also be modified to join the Zero-Flex edge neatly.

Product overview

ROUNDED TOPS AND SAFETY FEATURES

The smooth, rolled tops and rounded connector plate corners assist safe handling. When installed, all joins/fixings are internal so that the exposed top and front present as a smooth top edge and continuous fascia.

SAFER AND CLEANER HANDLING

We recommend wearing gloves as the manufacturing process can leave residual oils/dust and our products can get hot when exposed to sunlight. Our products are shipped in bundles, when lifting bundles handlers should be mindful of their carrying capabilities. Single items are easy to carry for one person (see product weights).

ABOUT WEATHERING STEEL

The manufacturing process of weathering steel leaves the surface in a dark, almost black state. This dark 'finish' is an oxide layer that forms during the hot rolling process. The weathering process needs to break this layer down first before the desired protective patina layer can be established. You can expect some inconsistency in the patina formation because the thickness of the oxide layer varies; it'll appear spotty with some areas going orange and others still black.

The patina develops naturally with periods of wet and dry, and both phases are key for its steady formation. Do not wet continually without allowing time for thorough drying. A faster patina formation can be aided by cleaning the surface with soapy water to remove oil residue, but anything harsher is not advised as it can be detrimental to patina development and consequently, reduce product lifespan. Some rust solution products are safe to use as these 'build a surface patina' rather than just accelerating rusting.

WHAT IS A PATINA

Patina is not the same as rust. All rust is patina, but not all patina is rust. Patina is a chemical bond between various elements and usually oxygen. It can be found on most metals with the exception of 8 inert (noble) metals like gold or silver. 'Normal' rust is iron-oxide, the patina referred to above is mostly a bond between copper, phosphorus, chromium, nickel, iron and oxygen. You may wonder, how does water feature in it? Water acts as an electrolyte, but

that's a different story. In the end, the patina formed on weathering steel is a dense layer that doesn't flake or allow oxygen through. Therefore, once formed, the oxidation process slows down dramatically.

LONGEVITY

Our products are of the highest quality ensuring longevity in the given environment. For further information please refer to the "Longevity Guide" and "Product Care Guide" on our website.

PAINTING, SEALING AND POWDERCOATING

Our galvanised products are suited to painting, but the surface should be thoroughly prepared (using acetone wash), and sealed with a metal primer (etch primer is very good) to maximise topcoat adhesion.

Powdercoating is a much more durable/hardy choice, and can be requested for large projects with lead times/costings supplied. It is worth noting that not all powdercoating performs the same, we use and recommend Interpon powder from AkzoNobel for assured quality and maximum endurance and suggest you request the same. It's also worth asking first to see a sample from your chosen powdercoater specialist.

Another question we get relates to freezing the colour (or patina development) at a certain stage. That's possible using a transparent sealant suitable for steel. Keep in mind that the colour will change when applying a sealant, it'll get a 'wet' look. Be sure to test this in a small inconspicuous area first before fully committing. This will require reapplication once a year.

HOW TO POSITION THE EDGE

The Flex and Rigid Garden Edging have a back and a front facing side. Consider which side will be the most visible in situ, based on your garden design and likely use of the area. For example, in a lawn edging install the smooth side would often face the lawn side so a smooth top portion presents with the neatly clipped lawn. These two edge styles do not have a foot which makes them ideal for retrofits along slightly crowded garden bed edges.

The Zero-Flex Garden Edging has no back or front facing side, so it looks smooth from both directions. The fixing screws and galvanised nails are used in the foot portion only, so they are hidden by the fill material used.

Fills such as mulch and stone may settle at lower than the install level and so require topping up later to maintain the look initially achieved. This top up practice can also increase lifespan, as the protective patina formation may be inconsistent in previously buried portions.

HOW DEEP DO I BURY THE EDGE?

The Flex and Rigid Garden Edging is designed to be mostly buried both in terms of the aesthetic finish and to maximise it's strength and durability. Curved installs do generate a strength of their own so some layouts allow Flex to be set higher and still maintain it's line well. Not burying the edge at all will leave join systems visible and see the edge more vulnerable to damage.

The Zero Flex Garden edging only requires partial burying to hide the foot, but when mostly buried it's strength and durability are greatest of all. Installed on a firm base and with fill near flush to the top of the edge it is impressively strong.

You may choose to leave a portion of the edge proud to help with material separation and containment, or for lawn maintenance practices of strimming against the edge itself.

WHY DO WE SUPPLY AND RECOMMEND TEK SCREWS?

You will see the pre-attached connector plate is fixed to the edge with rivets. This is the best method in the factory but when installing our edging Tek screws are a faster, stronger and easier option. We recommend using Tek screws to make life easier! The long lasting, grey Dacromet® Tek screws are recommended for all internal(buried) screw locations. With a weathering steel install, and on the rare occasions when the screws are visible the zinc colour Tek screws are used as they rust over, making them less aesthetically intrusive.

However, if you choose to use rivets be sure to use stainless steel and not aluminium which will disappear within a year or so. Aluminium, like zinc, is a sacrificial anode that protects the steel by sacrificing itself.

ADVANTAGES

- ✓ Continuous smooth rolled tops
- ✓ Corners available or easily made in situ
- ✓ Up to 3x faster installation
- ✓ No welding required
- ✓ No Experience/training needed
- ✓ Designed for ease of use

Straightcurve® Flex Garden Edging - 100mm

FL100WS WEATHERING STEEL | FL100GS GALVANISED STEEL

Product features

The details that make the difference



Connector plate and guide holes for precise and discreet joins



8mm Rounded Tops for child and pet safety

Double Rolled, Notched Top for smooth, even curves



Discreet presence for retrofits and design integrity

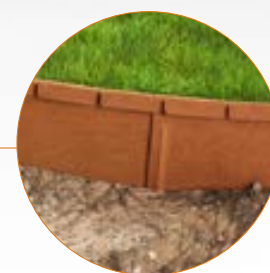

Moveable Lock-in Peg for easy obstacle avoidance

EDGE STYLE**FINISHES**

- Galvanised Steel
- Weathering Steel

For smoothly curving edging applications that hold position once shaped and installed.

Product specifications

TECHNICAL SPECIFICATIONS

Length (Installed)	2200mm
Top edge thickness	8mm
Steel plate thickness	1.6mm
Weight per length	4.0kg

BULK BUYING

Pack quantity	70
Bulk pack weight inc. pallet	300kg

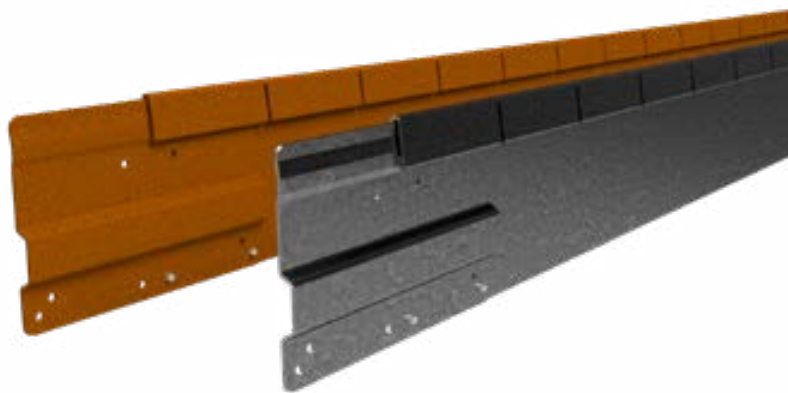
**SOLD AS SET INCLUDING**

- 1 x Connector plate (pre-attached)
- 3 x Fixing pegs, 300mm long

**ADDITIONAL ACCESSORIES**

- 500mm Corner piece (250 + 250mm arms, bend to desired angle)
- Hard surface fixing bracket
- Heavy duty peg

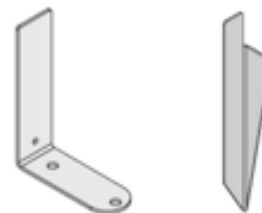

100mm Flex Installation Guide

Scan or click to watch install video

▶ INSTALL GUIDE



REQUIRED FIXINGS

- 2 x Tek Screws (12G x 16mm) or
- 2 x pop rivets (4mm shaft)

RECOMMENDED TOOLS

- Ground leveling tools
- Rubber mallet
- Cordless drill and Tek screw bit
- Angle grinder (only required if modifying lengths or fashioning ends)

PREPARATIONS

Mark the intended line on the ground and measure what length of edge is needed. Making a trench to set the edge into may be necessary. This will dictate the amount of edge that finishes proud and visible for your buried edge. For a retrofit, where surrounding heights are set, trench relative to these. For a new garden where surrounding materials may be added, the edge is sometimes installed without a trench, and then materials are filled up to and around it. Either way, burying the edge more deeply adds strength and assists curve support. Consider the 150mm or 240mm edge if more visibility of edge face is desired.

Note: This edge allows gentle sloping. Corners can be made or purchased as accessories. Length excess is cut away with angle grinder tool.

DO...

- ✔ Consider the best edge orientation in terms of smooth face/top edge viewing
- ✔ Join all lengths in place and perfect the line before finally fixing in position.
- ✔ Use some pegs to hold partially in place while reviewing position
- ✔ Flex rather than bend, especially if creating rings
- ✔ Use some Rigid lengths if your design has some straight sections, they have compatible connectors!

DON'T...

- ✘ Use for straight lines, instead use Rigid
- ✘ Forcibly bend. Take care and gently flex the edge to shape
- ✘ Accelerate rust with acids or salts, that's harmful to patina development
- ✘ Leave a square top corner unsafely protruding at an end, cap or round it off with a grinder instead.

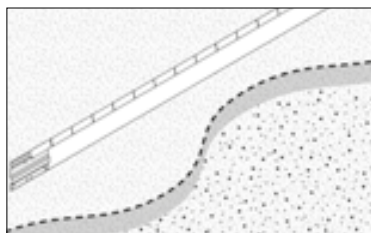

STEP 1 - Mark edge line on ground or by trenching and layout edge pieces.

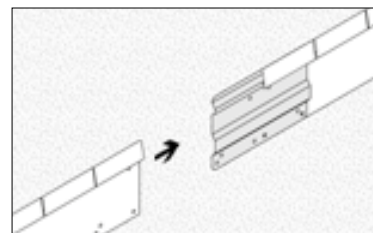

STEP 2 - Slide connector plate of one into the next to connect.

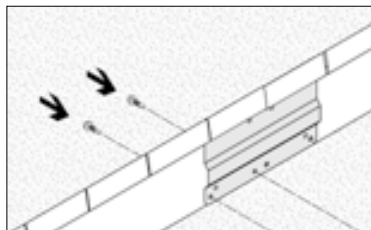

STEP 3 - Secure together with Tek screw through aligned guide holes.

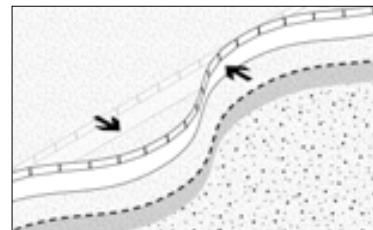

STEP 4 - Place, flex and connect all lengths along line, check line using pegs as temporary placeholders if needed.

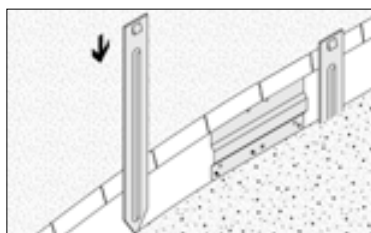

STEP 5 - Hammer all pegs adjacent edge (three per length) leaving them just above finishing height.

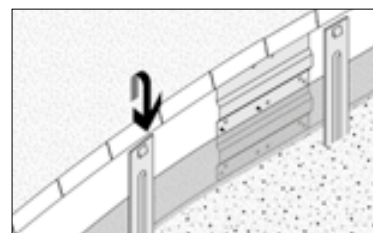

STEP 6 - Place edge onto pegs.

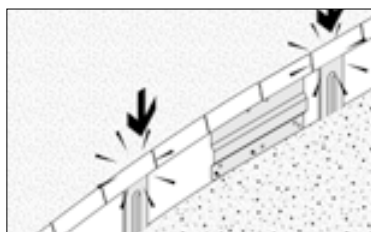

STEP 7 - Use rubber mallet to hammer edge on so peg locks in. Work down the line.

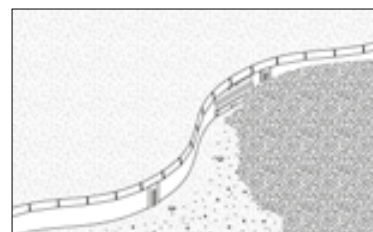

STEP 8 - Firming can be done with the rubber mallet, then backfill to finish.

CORNERS

Standard corners are available for purchase, but you can choose to make your own. Making your own corners will likely mean less waste, as the corners are simply made where they are needed with no offcuts created.

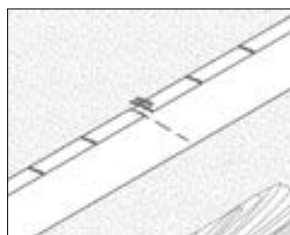

STEP 1 - Score a line down the back of the edge and create a sufficient opening (5-7mm) in the double folded lip at the top.

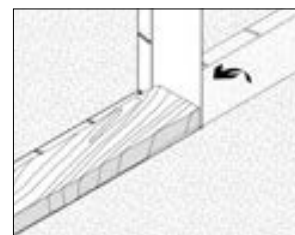

STEP 2 - Bend by hand. Placing a block of wood close to the fold improves the result.

JOINING EDGE TO A SURFACE OR ROCK

A join tab can be made using an angle grinder. This involves cutting away the top lip portion and scoring a fragmented fold line for the remaining tab piece. The tab is then bent as required for fixing and screwing to the surface it joins.

If butting up to a rock, using a diamond tip blade to cut a slot in the rock itself allows the edge to sit into it snugly, or just use the rock to hide the edge end safely behind it.

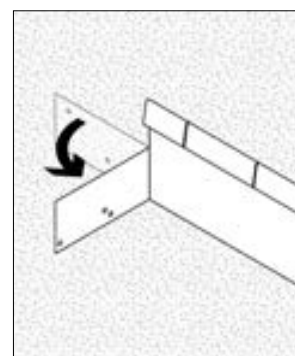
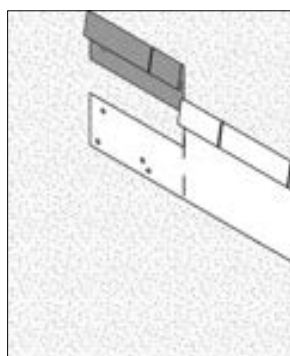

INSTALLING ON HARD SURFACES

Where ground conditions are too hard for standard pegs to penetrate, the Heavy Duty Peg may be used instead. These are first driven into the ground (hammer the hip, not the top part) and then the edge is hammered onto them with a rubber mallet to firmly wedge the Heavy Duty Peg in under the edge rim.

Alternatively the Hard Surface Fixing Bracket may be used. This also wedges firmly in under the edge rim when the edge is hammered onto it with a rubber mallet. This Hard Surface Fixing Bracket can be secured through the holes in the foot with galvanised spikes in hard ground or with DynaBolts™ when fixing to concrete. The DynaBolts™ or Fixing spikes utilised do not come with the bracket so need to be acquired separately.

On impermeable surfaces such as concrete, use packers to elevate the edge slightly; allowing drainage away from edge.

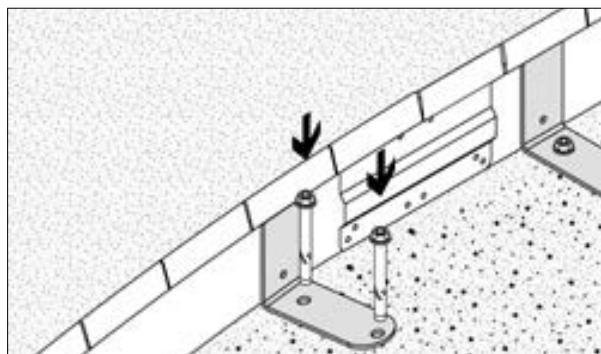
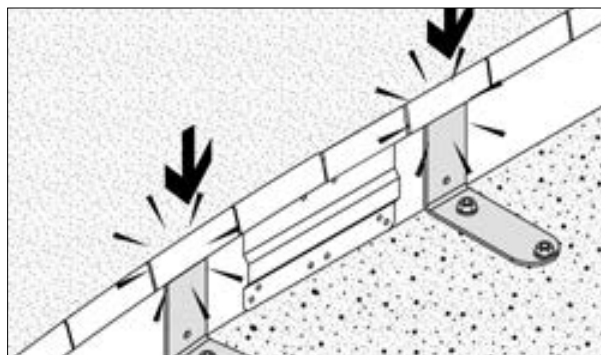

CIRCLES AND TIGHT CURVES

One length makes a tight 70cm diameter circle. Take care to gently flex the edge (i.e. do not bend) when forming the ring. Once the connector plate is aligned, Tek screw through the guide holes, then carefully adjust ring shape to your liking and fix to ground.

The tight ring made with one length is not completely smooth on the inside. You can add part of a length (which requires cutting) to get a smoother result. Using whole lengths only the diameters increase with each additional length, i.e. 141cm, 212cm, 283cm and so on.

As a guide the tightest curves without kinking the steel is equivalent to a radius of around 35cm. A further tip to achieve a tighter curve is to use your angle grinder to cut additional notches into the top lip in the section where it's needed.

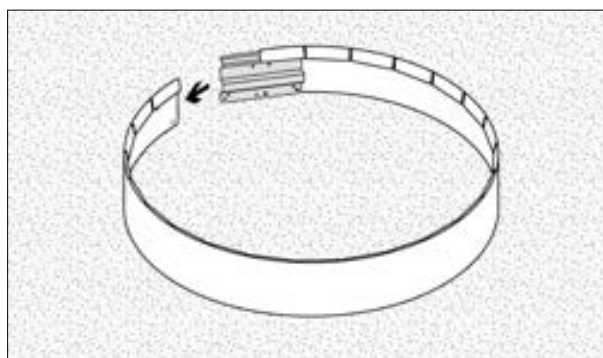

COMPATIBILITY

The 100mm Flex is compatible with the 100mm Rigid, because the joining plates and edge profile are exactly the same. This means you can use both together on the same project!

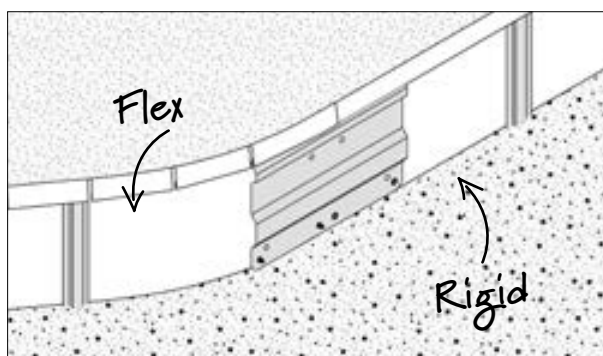

Straightcurve® Rigid Garden Edging - 100mm

RL100WS WEATHERING STEEL | RL100GS GALVANISED STEEL

Product features

The details that make the difference



Connector plate and guide holes for precise and discreet joins



8mm rounded tops for child and pet safety

Double rolled, continuous top for rigid straight lines

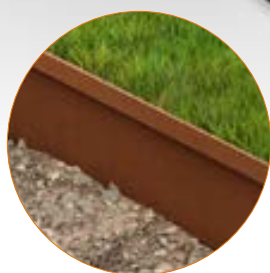

Discreet presence for retrofits and design integrity



Moveable lock-in peg for easy obstacle avoidance

EDGE STYLE**FINISHES**

- Galvanised Steel
- Weathering Steel

For creating straight or slightly curving lines

Product specifications

TECHNICAL SPECIFICATIONS

Length (Installed)	2200mm
Top edge thickness	8mm
Steel plate thickness	1.6mm
Weight per length	4.0kg

BULK BUYING

Pack quantity	70
Bulk pack weight inc. pallet	300kg

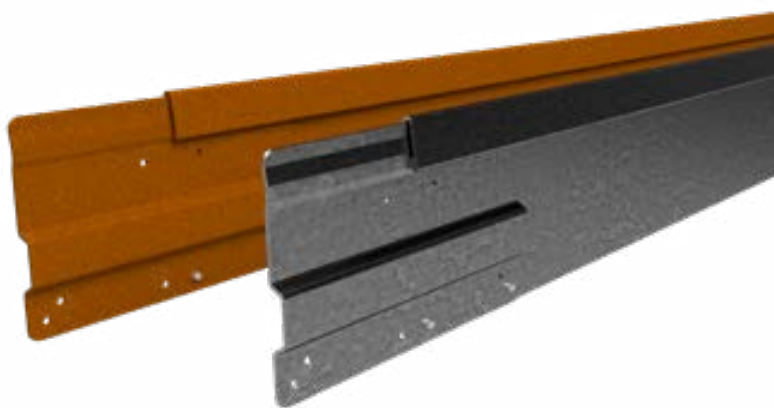
**SOLD AS SET INCLUDING**

- 1 x Connector plate (pre-attached)
- 3 x Fixing pegs, 300mm long

**ADDITIONAL ACCESSORIES**

- 500mm Corner piece (250 + 250mm arms, bend to desired angle)
- Hard surface fixing bracket
- Heavy duty peg



100mm Rigid Installation Guide

Scan or click to watch install video



▶ INSTALL GUIDE

REQUIRED FIXINGS

- 2 x Tek Screws (12G x 16mm) or
- 2 x pop rivets (4mm shaft)

RECOMMENDED TOOLS

- Ground leveling tools
- Rubber mallet
- Cordless drill and Tek screw bit
- Angle grinder (only required if modifying lengths or fashioning ends)

PREPARATIONS

Mark the intended line on the ground and measure what length of edge is needed. Making a trench to set the edge into may be necessary. This will dictate the amount of edge that finishes proud and visible for your buried edge. For a retrofit, where surrounding heights are set, trench relative to these. For a new garden where surrounding materials may be added, the edge is sometimes installed without a trench, and then materials are filled up to and around it. Either way, burying the edge more deeply adds strength and assists curve support. Consider the 150mm or 240mm edge if more visibility of edge face is desired.

Note: This edge will allow slight curving. Corners can be made in situ or purchased as accessories.

DO...

- ✓ Use for straight lines or very slight curves
- ✓ Consider the best edge orientation in terms of smooth face/top edge viewing
- ✓ Take care to position pegs exactly in line
- ✓ Use some Flex lengths if your design has some curved sections, they're compatible!

DON'T...

- ✗ Use for tight curving lines, instead use Flex edge
- ✗ Forcibly bend. This Rigid edge will shape gently for a slight curve only
- ✗ Accelerate rust with acids or salts, that's harmful to patina development

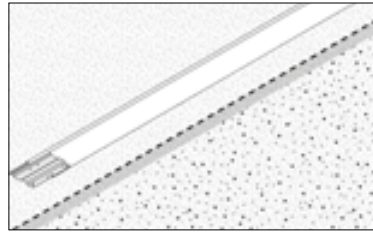

STEP 1 - Mark edge line on ground or by trenching and layout edge pieces.

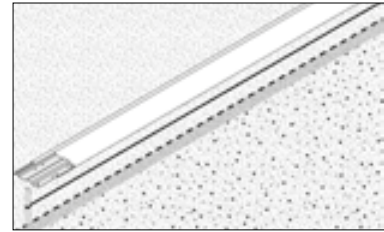

STEP 2 - Be sure trench depth is right and set string line, laser or other method to mark line.

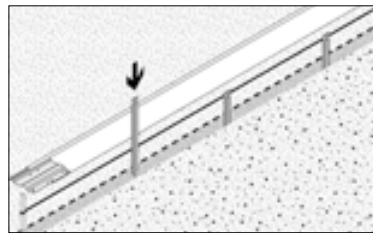

STEP 3 - Evenly space and hammer in pegs (three per length) directly along line to just above finishing height.

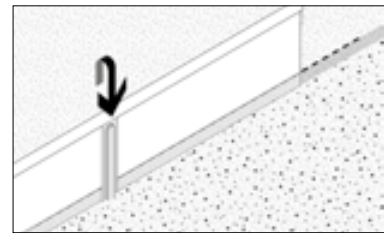

STEP 4 - Place first edge onto first three pegs (start at edge end without a connector plate).

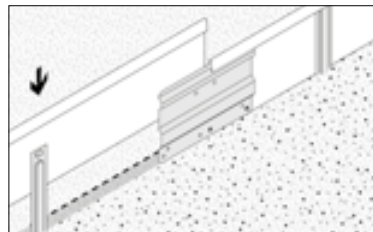

STEP 5 - Place next edge down onto pegs and connector plate of first edge for joining.

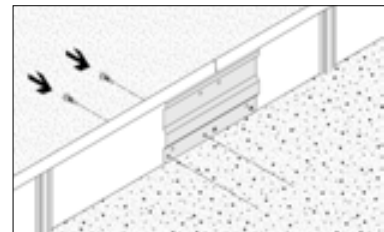

STEP 6 - Align guide holes for snug join, Secure with tek screws.

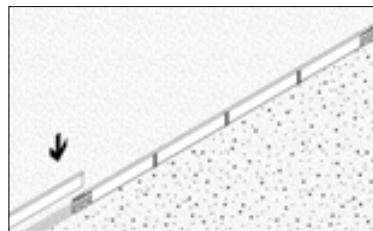

STEP 7 - Introduce further lengths, connecting them as you go along the install line.

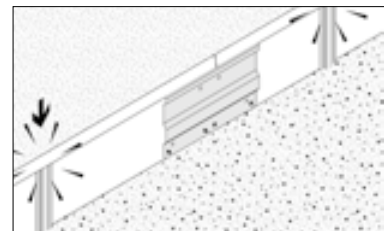

STEP 8 - Once all are in place, use rubber mallet to firmly strike edge so pegs lock in.

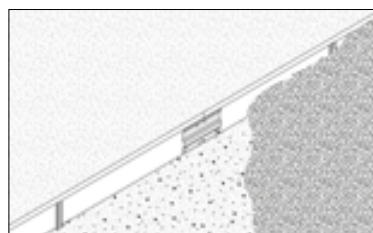

STEP 9 - Then backfill to finish, packing fill around the edge.

CORNERS

Standard corners are available for purchase, but you can choose to make your own. Making your own corners will likely mean less waste, as the corners are simply made where they are needed with no offcuts created.

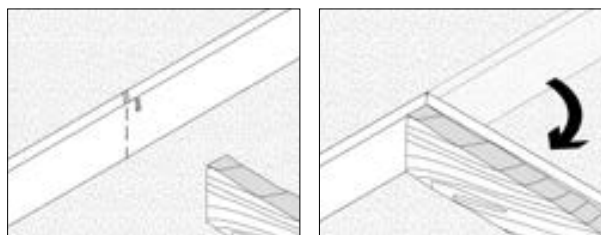

STEP 1 - Score a line down the back of the edge and create a sufficient opening (5-7mm) in the double folded lip at the top.

STEP 2 - Bend by hand. Placing a block of wood close to the fold improves the result.

GEOMETRIC SHAPES

You may look to create the likes of rectangles or squares such as for tree surrounds. To do so measure carefully and create the corners where needed. Alternatively purchase four corners for an exact 500mm square shape.

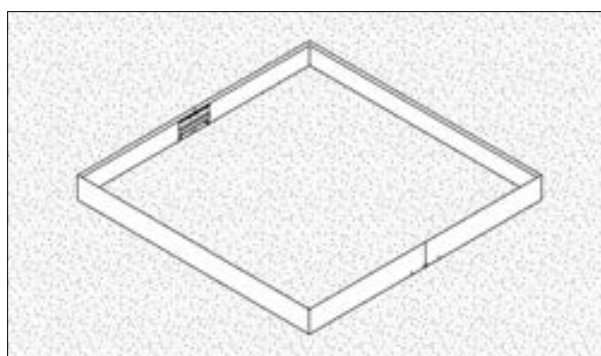

INSTALLING ON HARD SURFACES

Where ground conditions are too hard for standard pegs to penetrate, the heavy duty peg may be used instead. These are first driven into the ground (hammer the hip, not the top part) and then the edge is hammered onto them with a rubber mallet to firmly wedge the heavy duty peg in under the edge rim.

Alternatively the Hard Surface Fixing Bracket may be used. This also wedges firmly in under the edge rim when the edge is hammered onto it with a rubber mallet. This Hard Surface Fixing bracket can be secured through the holes in the foot with galvanised spikes in hard ground or with DynaBolts™ when fixing to concrete. The DynaBolts™ or Fixing spikes utilised do not come with the bracket so need to be acquired separately.

On impermeable surfaces such as concrete, use packers to elevate the edge slightly; allowing drainage away from edge.

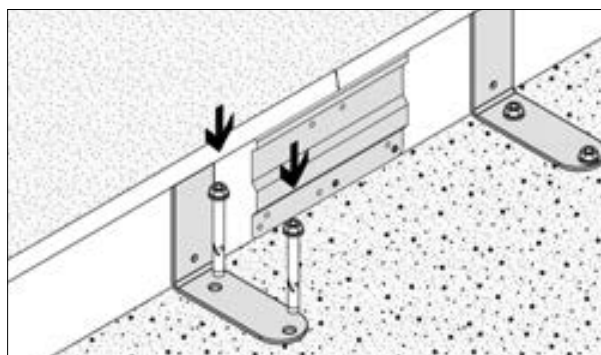
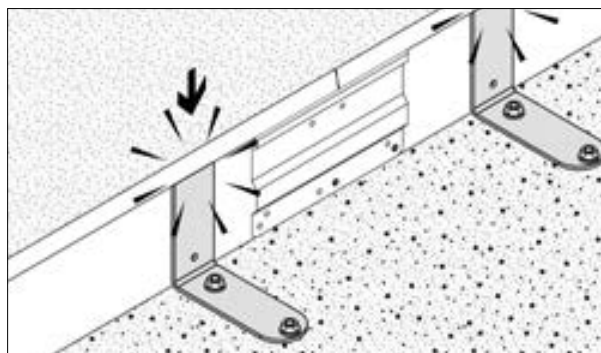

JOINING EDGE TO A SURFACE OR ROCK

A join tab can be made using an angle grinder. This involves cutting away the top lip portion and scoring a fragmented fold line for the remaining tab piece. The tab is then bent as required for fixing and screwing to the surface it joins.

If butting up to a rock, using a diamond tip blade to cut a slot in the rock itself allows the edge to sit into it snugly, or just use the rock to hide the edge end safely behind it.

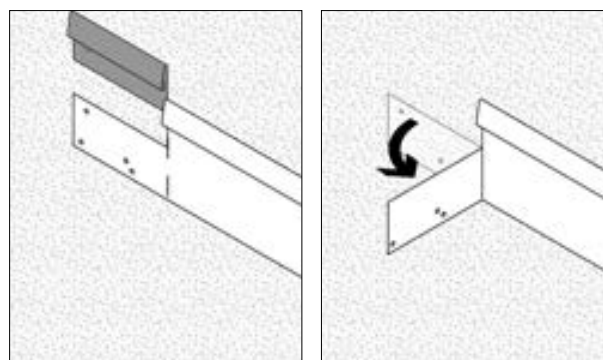

COMPATIBILITY

The 150mm Rigid is compatible with the 150mm Flex, because the joining plates and edge profile are exactly the same. This means you can use both together on the same project!

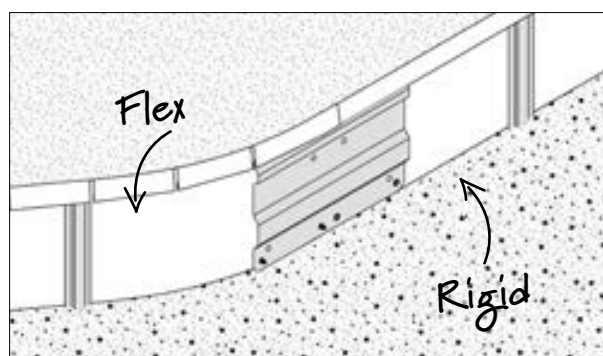

Straightcurve® Zero-Flex Garden Edging - 100mm

HL100WS WEATHERING STEEL | HL100GS GALVANISED STEEL

Product features

The details that make the difference

Connector plate and guide holes for precise and discreet joins



Two-way Continuous Foot for holding straight lines



Double wall and rolled top for structural strength



7mm rounded tops for child and pet safety



Moveable fixing spikes for easy obstacle avoidance



EDGE STYLE



FINISHES

- Galvanised Steel
- Weathering Steel

For lasting, perfectly straight unmovable lines

Product specifications

TECHNICAL SPECIFICATIONS

Length (Installed)	2200mm
Top edge thickness	7mm
Steel plate thickness	1.6mm
Weight per length	6.4kg

BULK BUYING

Pack quantity	22
Bulk pack weight inc. pallet	160kg

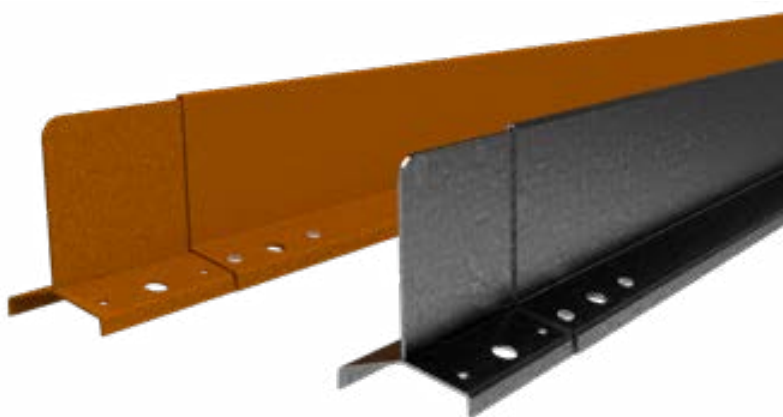

SOLD AS SET INCLUDING

- 1 x Connector plate (pre-attached)
- 4 x Galvanised spikes, 300mm long



ADDITIONAL ACCESSORIES

- 500mm (250mm + 250mm) Corner piece (reversible) (bend to desired angle)

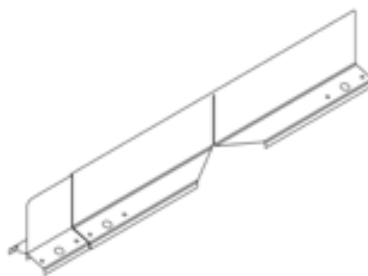

100mm Zero-Flex Installation Guide

Scan or click to watch install video

▶ INSTALL GUIDE



REQUIRED FIXINGS

- 4 x Tek Screws (12G x 16mm) or
- 4 x pop rivets (4mm shaft)

RECOMMENDED TOOLS

- Ground leveling tools
- Rubber mallet
- Cordless drill and Tek screw bit
- Angle grinder (only required if modifying lengths or fashioning ends)

PREPARATIONS

Mark the intended line on the ground to measure what length of edge is needed.

A firmer, compacted base is best for installing Zero-Flex and may need to be prepared first. This foundation is key for the edges strength and line holding capability.

For a retrofit, where surrounding heights are set, trench relative to these. For a new garden where surrounding materials may be added, the edge is sometimes installed without a trench, and then materials are filled up to and around it. The trench depth dictates the amount of edge that finishes proud and visible. Burying the edge more deeply adds strength, as does having firm flat ground as the foundation. Consider the 150mm Zero-Flex if more visibility of edge face is desired.

DO...

- ✓ Pay attention to best ground preparation for a firm foundation
- ✓ Get the depth of trench right the first time
- ✓ Join all lengths and corners in place and perfect the line before finally fixing in position

DON'T...

- ✗ Use all galvanised spikes on one side only
- ✗ Skip the screwing stage, these lock in the seamless join
- ✗ Accelerate rust with acids or salts, that's harmful to patina development
- ✗ Leave a square top corner unsafely protruding at an end, cap or round it off with a grinder instead.

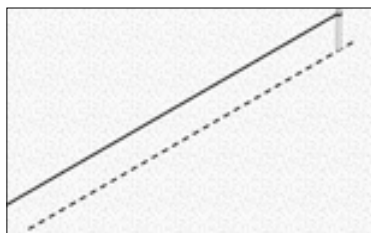

STEP 1 - Use string line or mark edge line on a firm base.

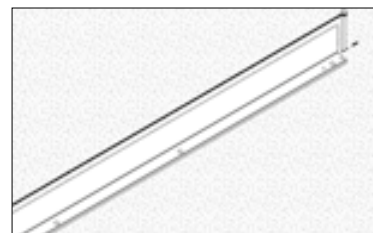

STEP 2 - Position first edges along the desired line.

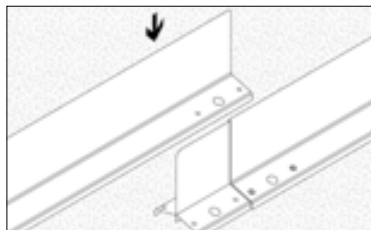

STEP 3 - Slide connector plate of one edge into the next to connect.

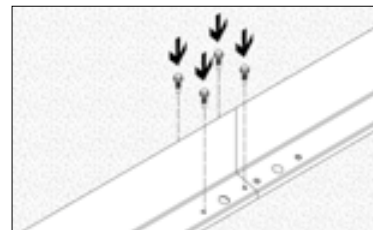

STEP 4 - Secure together with Tek screw through aligned guide holes.

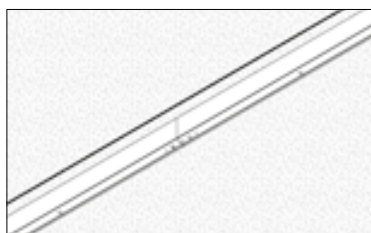

STEP 5 - Introduce further lengths, connecting them as you go along the install line.

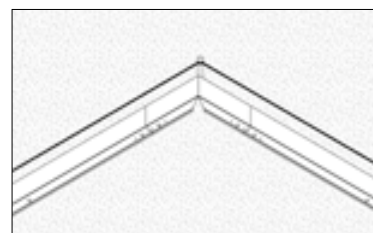

STEP 6 - Form and introduce corners where needed (lengths may need to be cut with grinder).

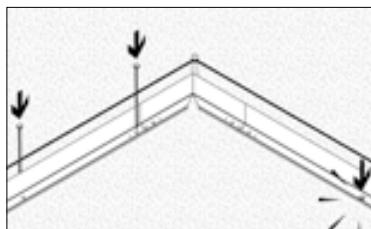

STEP 7 - Check position then hammer four galvanised spikes per length through foot holes, either side and evenly spaced.

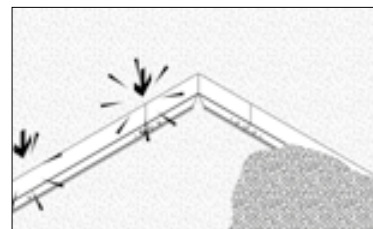

STEP 8 - Firing can be done with the rubber mallet, then backfill to finish

Bonus Tip! When is adding concrete footings a good idea?

For a Zero-Flex install on soft/sandy/shifting ground conditions consider setting the galvanised fixing spikes and the join sections into some concrete. Fill materials on both sides also add strength and can remove the need for concrete, but the foundation the edge sits on is always key to Zero-Flex's strength.

CORNERS

Standard corners are available for purchase, and their direction can be reversed when required by moving the connector plate to the other arm. Alternatively, you can choose to make your own corners. Making your own corners will likely mean less waste, as the corners are simply made where they are needed with no offcuts created.

Suggestion: Purchase one corner, and use that as a template for cutting in corners in other whole lengths where needed.

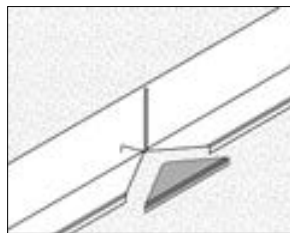

STEP 1 - Cut down the vertical wall (not to the very top) and cut away a V in the shoulder foot (at least 120 degrees) on the side where you will bend it in.

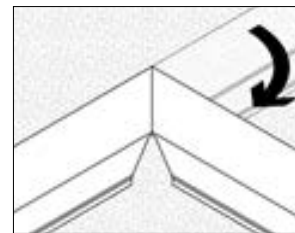

STEP 2 - Make a single cut on the opposing side shoulder (see step 1 diagram) then bend in the corner.

RECTANGLES & SQUARES

To create rectangles or squares be precise with your marking out before cutting. It's possible to join four corner pieces to easily make a 500mm x 500mm square. Similarly corners could be utilised with full lengths or part thereof, to make larger square or rectangular beds.

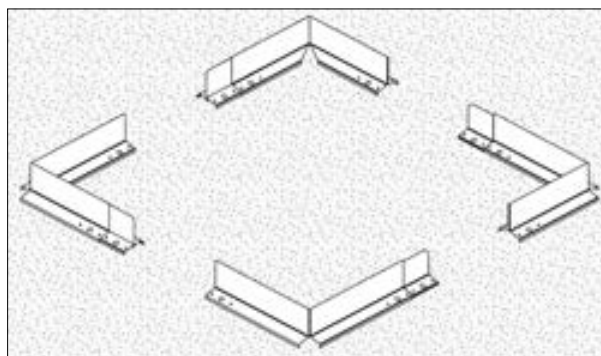

INSTALLING ON HARD SURFACES

The edge can be installed on a hard surface. When the surface is very hard but penetrable, use the galvanised spikes supplied. If the surface is impenetrable, such as with concrete, a bolt down approach (purchase separately) can be applied. Utilise the same fixing holes but use packers to raise the edge slightly to allow drainage away from the edge.

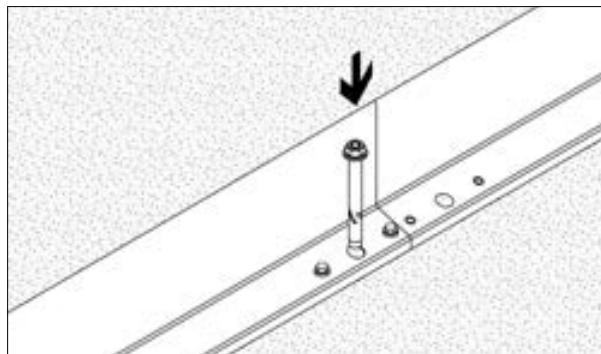

COMPATIBILITY

The Zero-Flex can have the equivalent height Flex product connected to it if a curved section is required. The top profiles are not exactly the same, but very similar when butted together. The Flex connector plate will slot into the Zero-Flex and would then need custom securing down low with some Tek screws.

Where the non-connector plate end of the flexline meets Zero-Flex Garden Edging (see adjacent pics), cut out a lower portion of the Flex edge to allow it to sit neatly onto the Zero-Flex edge connector plate and secure with screws.

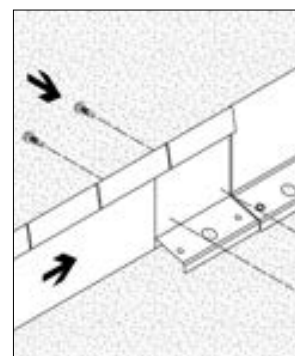
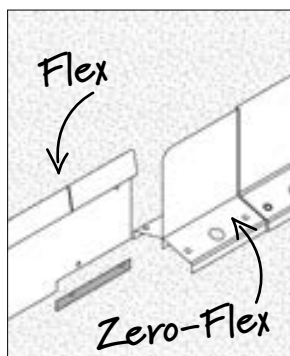

Technical Drawings

75mm

100mm

150mm

240mm

400mm

560mm

Planter boxes

STRAIGHTCURVE® FLEX GARDEN EDGING - 100MM

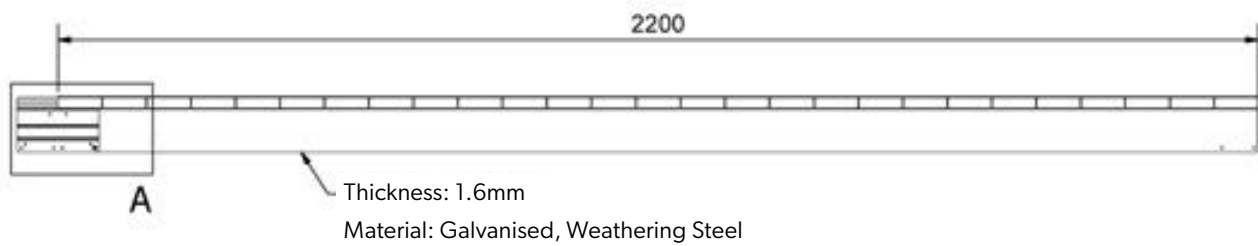

STRAIGHTCURVE® RIGID GARDEN EDGING - 100MM

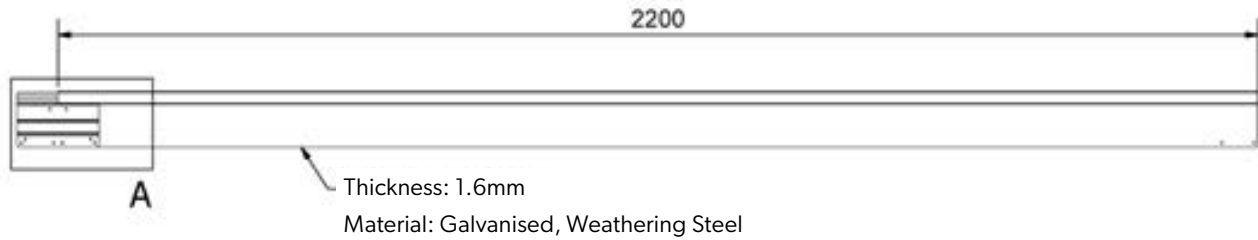

UNIVERSAL SPECIFICATIONS

SIDE PROFILE

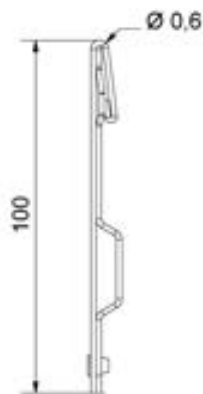

CONNECTOR PLATE

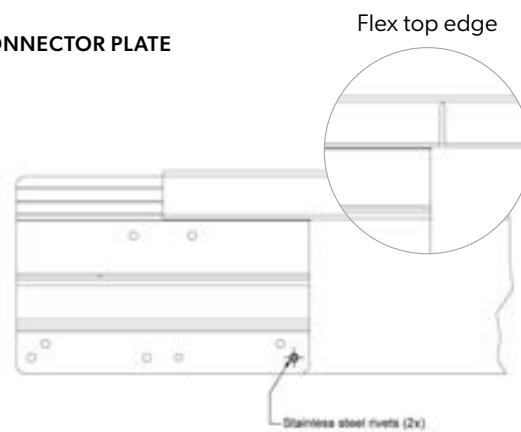

HARD SURFACE FIXING BRACKET

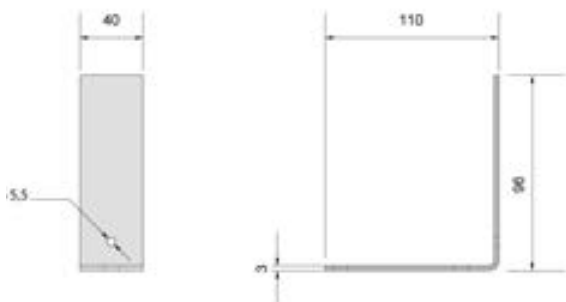

HEAVY DUTY PEG

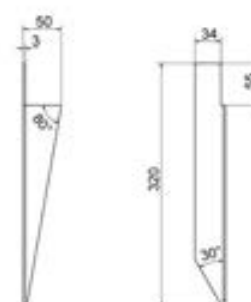



75mm

100mm

150mm

240mm

400mm

560mm

Planter boxes

STRAIGHTCURVE® ZERO-FLEX GARDEN EDGING - 100MM

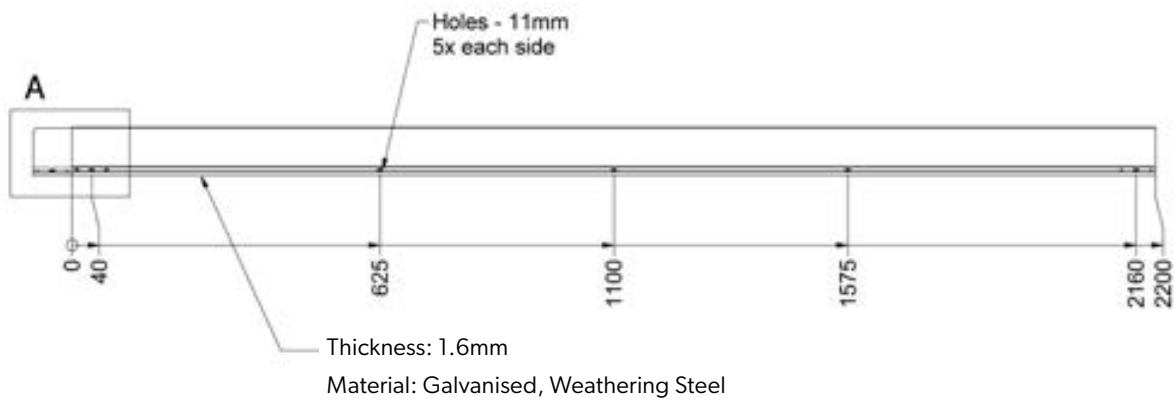

SIDE PROFILE



CONNECTOR PLATE

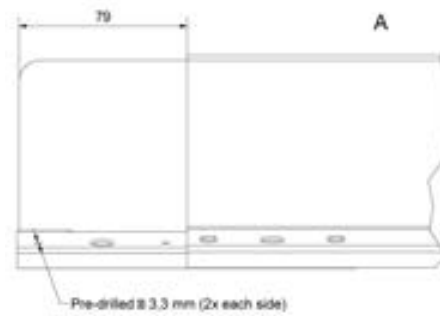

150mm Garden Edging

For curved and straight edging situations.

Do you know what edging product is best for your project? Let's figure that out together here!

Firstly, what are you trying to do?

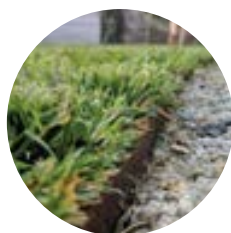

LAWN EDGE

Lawn edge for invasive grasses and plants

OR



PATHWAYS/RETAINING

Paving, stone and crush retainer edge

OR

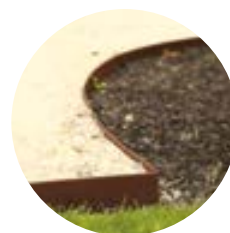

DIVIDER

Divider between gravels/ woodchips/ mulches etc

Perhaps it looks something like these?



Straightcurve® Flex Garden Edging - 150mm



Straightcurve® Zero-Flex Garden Edging - 150mm

How do you choose from our three 150mm edging options?

We have solutions for curved and straight edging situations. Consider what matters to you so you can be sure of selecting the best option from our range. It's your call and we hope this selection table makes it easier!

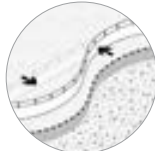
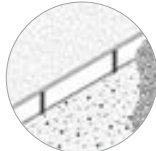
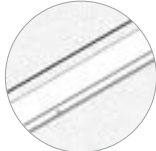
I'm looking for...	We recommend for this ...		
	 Flex - 150	 Rigid - 150	 Zero-Flex - 150
Something I can do myself	✓	✓	✓
Something flexible enough to make tight curves with ease	✓	✗	✗
Tree rings	✓	✗	✗
An edge that creates a strong gentle curve, for a radius exceeding 4m	✗	✓	✗
Something rigid that helps me to create a straight run	✗	✓	✓
A straight edge that will stay true and won't waver	✗	✗	✓
An edge ideally suited to run pavers up to, instead of a concrete haunch	✗	✗	✓

Did you know? It's also possible to combine styles, as our Flex Garden Edging and Rigid Garden Edging are join and profile compatible. Flex edging can also be modified to join the Zero-Flex edge neatly.

Product overview

ROUNDED TOPS AND SAFETY FEATURES

The smooth, rolled tops and rounded connector plate corners assist safe handling. When installed, all joins/fixings are internal so that the exposed top and front present as a smooth top edge and continuous fascia.

SAFER AND CLEANER HANDLING

We recommend wearing gloves as the manufacturing process can leave residual oils/dust and our products can get hot when exposed to sunlight. Our products are shipped in bundles, when lifting bundles handlers should be mindful of their carrying capabilities. Single items are easy to carry for one person (see product weights).

ABOUT WEATHERING STEEL

The manufacturing process of weathering steel leaves the surface in a dark, almost black state. This dark 'finish' is an oxide layer that forms during the hot rolling process. The weathering process needs to break this layer down first before the desired protective patina layer can be established. You can expect some inconsistency in the patina formation because the thickness of the oxide layer varies; it'll appear spotty with some areas going orange and others still black.

The patina develops naturally with periods of wet and dry, and both phases are key for its steady formation. Do not wet continually without allowing time for thorough drying. A faster patina formation can be aided by cleaning the surface with soapy water to remove oil residue, but anything harsher is not advised as it can be detrimental to patina development and consequently, reduce product lifespan. Some rust solution products are safe to use as these 'build a surface patina' rather than just accelerating rusting.

WHAT IS A PATINA

Patina is not the same as rust. All rust is patina, but not all patina is rust. Patina is a chemical bond between various elements and usually oxygen. It can be found on most metals with the exception of 8 inert (noble) metals like gold or silver. 'Normal' rust is iron-oxide, the patina referred to above is mostly a bond between copper, phosphorus, chromium, nickel, iron and oxygen. You may wonder, how does water feature in it? Water acts as an electrolyte, but

that's a different story. In the end, the patina formed on weathering steel is a dense layer that doesn't flake or allow oxygen through. Therefore, once formed, the oxidation process slows down dramatically.

LONGEVITY

Our products are of the highest quality ensuring longevity in the given environment. For further information please refer to the "Longevity Guide" and "Product Care Guide" on our website.

PAINTING, SEALING AND POWDERCOATING

Our galvanised products are suited to painting, but the surface should be thoroughly prepared (using acetone wash), and sealed with a metal primer (etch primer is very good) to maximise topcoat adhesion.

Powdercoating is a much more durable/hardy choice, and can be requested for large projects with lead times/costings supplied. It is worth noting that not all powdercoating performs the same, we use and recommend Interpon powder from AkzoNobel for assured quality and maximum endurance and suggest you request the same. It's also worth asking first to see a sample from your chosen powdercoater specialist.

Another question we get relates to freezing the colour (or patina development) at a certain stage. That's possible using a transparent sealant suitable for steel. Keep in mind that the colour will change when applying a sealant, it'll get a 'wet' look. Be sure to test this in a small inconspicuous area first before fully committing. This will require reapplication once a year.

75mm

100mm

150mm

240mm

400mm

560mm

Planter boxes

HOW TO POSITION THE EDGE

The Flex and Rigid Garden Edging have a back and a front facing side. Consider which side will be the most visible in situ, based on your garden design and likely use of the area. For example, in a lawn edging install the smooth side would often face the lawn side so a smooth top portion presents with the neatly clipped lawn. These two edge styles do not have a foot which makes them ideal for retrofits along slightly crowded garden bed edges.

The Zero-Flex Garden Edging has no back or front facing side, so it looks smooth from both directions. The fixing screws and galvanised nails are used in the foot portion only, so they are hidden by the fill material used.

Fills such as mulch and stone may settle at lower than the install level and so require topping up later to maintain the look initially achieved. This top up practice can also increase lifespan, as the protective patina formation may be inconsistent in previously buried portions.

HOW DEEP DO I BURY THE EDGE?

The Flex and Rigid Garden Edging is designed to be mostly buried both in terms of the aesthetic finish and to maximise it's strength and durability. Curved installs do generate a strength of their own so some layouts allow Flex to be set higher and still maintain it's line well. Not burying the edge at all will leave join systems visible and see the edge more vulnerable to damage.

The Zero Flex Garden edging only requires partial burying to hide the foot, but when mostly buried it's strength and durability are greatest of all. Installed on a firm base and with fill near flush to the top of the edge it is impressively strong.

You may choose to leave a portion of the edge proud to help with material separation and containment, or for lawn maintenance practices of strimming against the edge itself.

WHY DO WE SUPPLY AND RECOMMEND TEK SCREWS?

You will see the pre-attached connector plate is fixed to the edge with rivets. This is the best method in the factory but when installing our edging Tek screws are a faster, stronger and easier option. We recommend using Tek screws to make life easier! The long lasting, grey Dacromet® Tek screws are recommended for all internal(buried) screw locations. With a weathering steel install, and on the rare occasions when the screws are visible the zinc colour Tek screws are used as they rust over, making them less aesthetically intrusive.

However, if you choose to use rivets be sure to use stainless steel and not aluminium which will disappear within a year or so. Aluminium, like zinc, is a sacrificial anode that protects the steel by sacrificing itself.

ADVANTAGES

- ✓ Continuous smooth rolled tops
- ✓ Corners available or easily made in situ
- ✓ Up to 3x faster installation
- ✓ No welding required
- ✓ No Experience/training needed
- ✓ Designed for ease of use

Straightcurve® Flex Garden Edging - 150mm

FL150WS WEATHERING STEEL | FL150GS GALVANISED STEEL

Product features

The details that make the difference

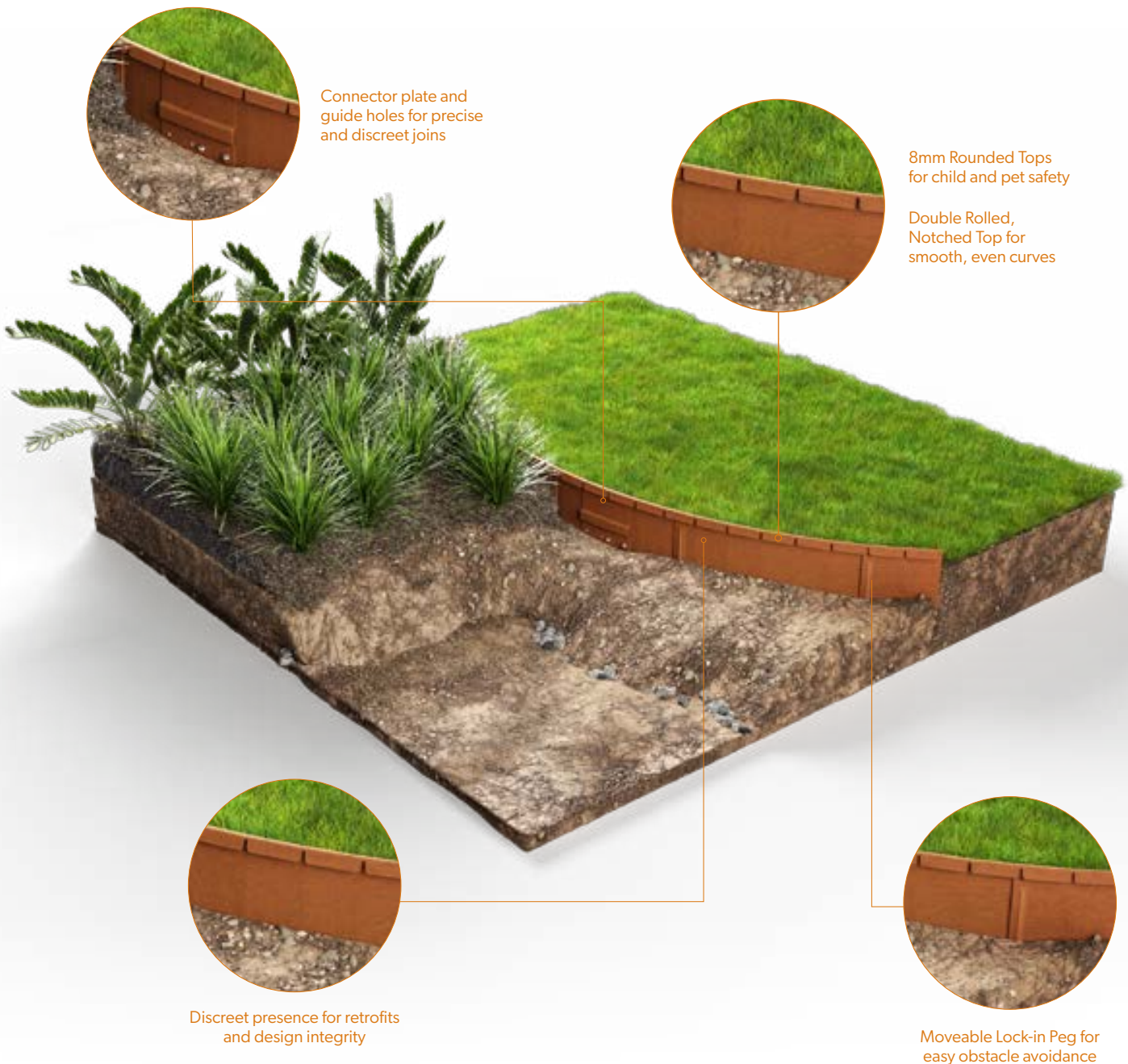

Connector plate and
guide holes for precise
and discreet joins

8mm Rounded Tops
for child and pet safety

Double Rolled,
Notched Top for
smooth, even curves

Discreet presence for retrofits
and design integrity

Moveable Lock-in Peg for
easy obstacle avoidance

EDGE STYLE



For smoothly curving edging applications that hold position once shaped and installed.

FINISHES

- Galvanised Steel
- Weathering Steel

Product specifications

TECHNICAL SPECIFICATIONS

Length (Installed)	2200mm
Top edge thickness	8mm
Steel plate thickness	1.6mm
Weight per length	5.4kg

BULK BUYING

Pack quantity	50
Bulk pack weight inc. pallet	290kg

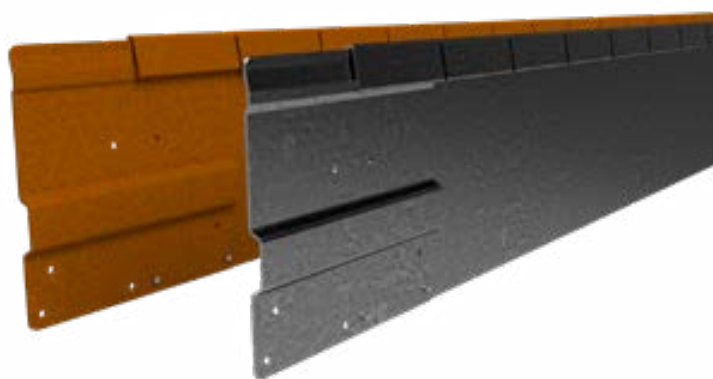

SOLD AS SET INCLUDING

- 1 x Connector plate (pre-attached)
- 3 x Fixing pegs, 300mm long



ADDITIONAL ACCESSORIES

- 500mm Corner piece (250 + 250mm arms, bend to desired angle)
- Hard surface fixing bracket
- Heavy duty peg

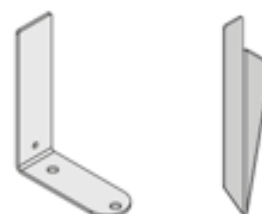

150mm Flex Installation Guide

Scan or click to watch install video



▶ INSTALL GUIDE

REQUIRED FIXINGS

- 2 x Tek Screws (12G x 16mm) or
- 2 x pop rivets (4mm shaft)

RECOMMENDED TOOLS

- Ground leveling tools
- Rubber mallet
- Cordless drill and Tek screw bit
- Angle grinder (only required if modifying lengths or fashioning ends)

PREPARATIONS

Making a trench to set the edge into is usually necessary. This will dictate the amount of edge that finishes proud and visible for your buried edge. For a retrofit, where surrounding heights are set, trench relative to these. For a new garden where surrounding materials may be added, the edge is sometimes installed without a trench, and then materials are filled up to and around it. Either way, burying the edge more deeply adds strength and assists curve support, consider the 240mm edge if more visibility of edge face is desired.

Note: This edge allows gentle sloping. Corners can be made or purchased as accessories. Length excess is cut away with angle grinder tool.

DO...

- ✔ Consider the best edge orientation in terms of smooth face/top edge viewing
- ✔ Join all lengths in place and perfect the line before finally fixing in position.
- ✔ Use some pegs to hold partially in place while reviewing position
- ✔ Flex rather than bend, especially if creating rings
- ✔ Use some Rigid lengths if your design has some straight sections, they have compatible connectors!

DON'T...

- ✘ Use for straight lines, instead use Rigid or Zero-Flex
- ✘ Forcibly bend. Take care and gently flex the edge to shape
- ✘ Accelerate rust with acids or salts, that's harmful to patina development
- ✘ Leave a square top corner unsafely protruding at an end, cap or round it off with a grinder instead.

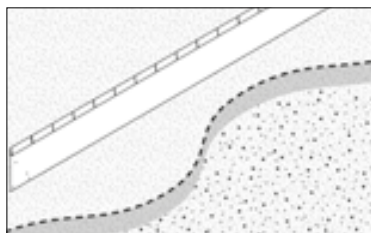

STEP 1 - Mark edge line on ground or by trenching and layout edge pieces.

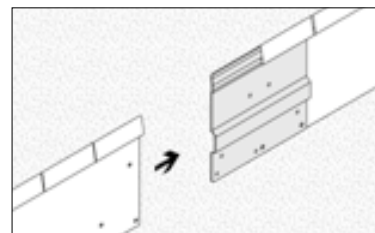

STEP 2 - Slide connector plate of one into the next to connect.

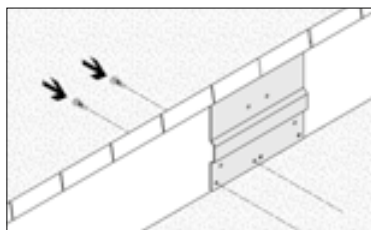

STEP 3 - Secure together with Tek screw through aligned guide holes.

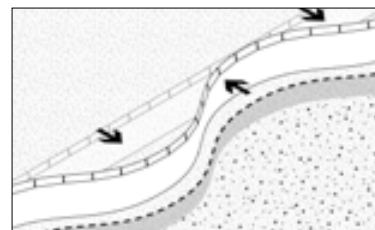

STEP 4 - Place, flex and connect all lengths along line, check line using pegs as temporary placeholders if needed.

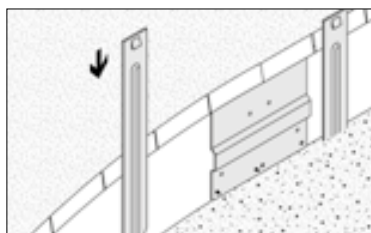

STEP 5 - With line just right, hammer all pegs adjacent edge (three per length) leaving them just above finishing height.

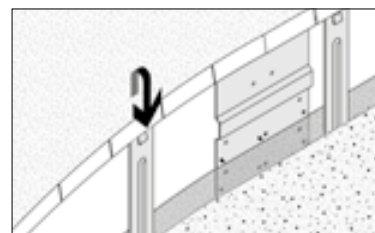

STEP 6 - Place edge onto pegs and use rubber mallet to hammer edge on so peg locks in. Work down the line.

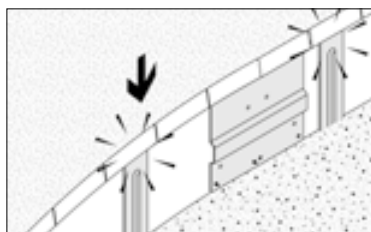

STEP 7 - Firming can be done with the rubber mallet.

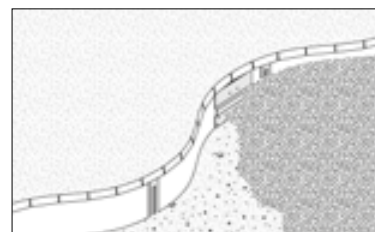

STEP 8 - Backfill to finish.

CORNERS

Standard corners are available for purchase, but you can choose to make your own. Making your own corners will likely mean less waste, as the corners are simply made where they are needed with no offcuts created.

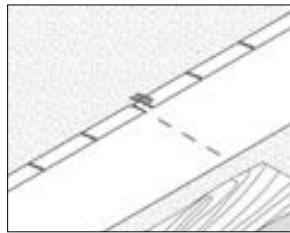

STEP 1 - Score a line down the back of the edge and create a sufficient opening (5-7mm) in the double folded lip at the top.

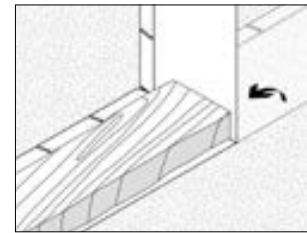

STEP 2 - Bend by hand. Placing a block of wood close to the fold improves the result.

JOINING EDGE TO A SURFACE OR ROCK

A join tab can be made using an angle grinder. This involves cutting away the top lip portion and scoring a fragmented fold line for the remaining tab piece. The tab is then bent as required for fixing and screwing to the surface it joins.

If butting up to a rock, using a diamond tip blade to cut a slot in the rock itself allows the edge to sit into it snugly, or just use the rock to hide the edge end safely behind it.

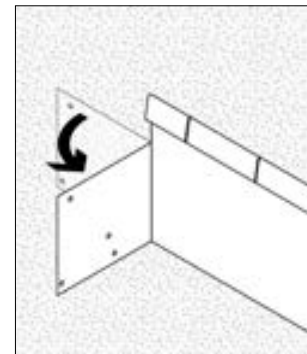
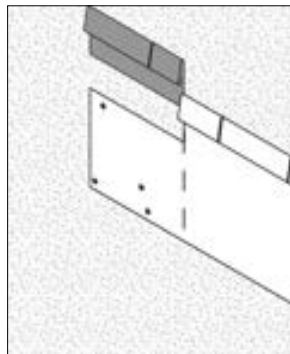

INSTALLING ON HARD SURFACES

Where ground conditions are too hard for standard pegs to penetrate, the Heavy Duty Peg may be used instead. These are first driven into the ground (hammer the hip, not the top part) and then the edge is hammered onto them with a rubber mallet to firmly wedge the Heavy Duty Peg in under the edge rim.

Alternatively the Hard Surface Fixing Bracket may be used. This also wedges firmly in under the edge rim when the edge is hammered onto it with a rubber mallet. This Hard Surface Fixing Bracket can be secured through the holes in the foot with galvanised spikes in hard ground or with DynaBolts™ when fixing to concrete. The DynaBolts™ or Fixing spikes utilised do not come with the bracket so need to be acquired separately.

On impermeable surfaces such as concrete, use packers to elevate the edge slightly; allowing drainage away from edge.

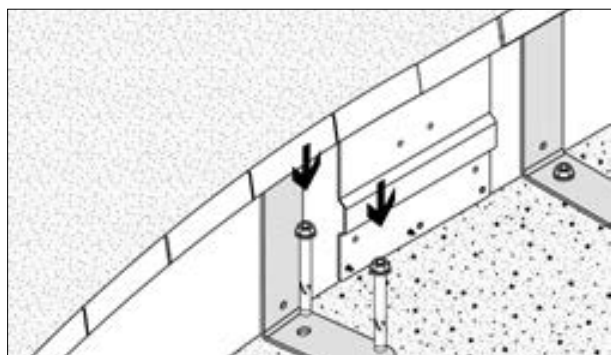
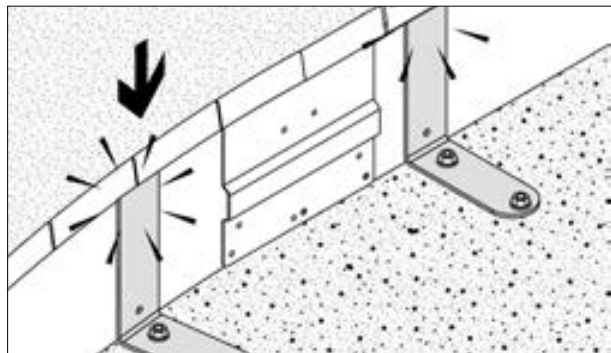

CIRCLES & TIGHT CURVES

One length makes a tight 70cm diameter circle. Take care to gently flex the edge (i.e. do not bend) when forming the ring. Once the connector plate is aligned, Tek screw through the guide holes, then carefully adjust ring shape to your liking and fix to ground.

The tight ring made with one length is not completely smooth on the inside. You can add part of a length (which requires cutting) to get a smoother result. Using whole lengths only the diameters increase with each additional length, i.e. 141cm, 212cm, 283cm and so on.

As a guide the tightest curves without kinking the steel is equivalent to a radius of around 35cm. A further tip to achieve a tighter curve is to use your angle grinder to cut additional notches into the top lip in the section where it's needed.

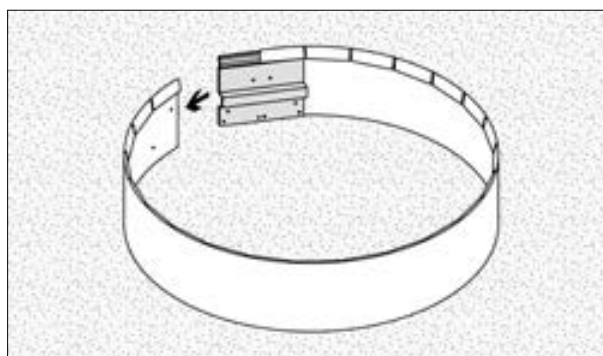

COMPATIBILITY

The 150mm Flex is compatible with the 150mm Rigid, because the joining plates and edge profile are exactly the same. This means you can use both together on the same project!

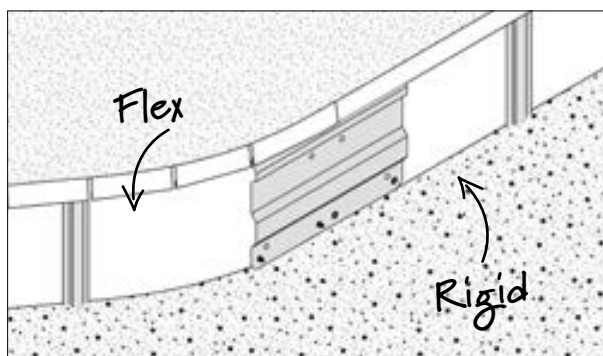

Straightcurve® Rigid Garden Edging - 150mm

RL150WS WEATHERING STEEL | RL150GS GALVANISED STEEL

Product features

The details that make the difference



Connector plate and guide holes for precise and discreet joins

8mm rounded tops for child and pet safety

Double rolled, continuous top for rigid straight lines

Discreet presence for retrofits and design integrity

Moveable lock-in peg for easy obstacle avoidance

EDGE STYLE



FINISHES

- Galvanised Steel
- Weathering Steel

For creating straight or slightly curving lines

Product specifications

TECHNICAL SPECIFICATIONS

Length (Installed)	2200mm
Top edge thickness	8mm
Steel plate thickness	1.6mm
Weight per length	5.4kg

BULK BUYING

Pack quantity	50
Bulk pack weight inc. pallet	290kg

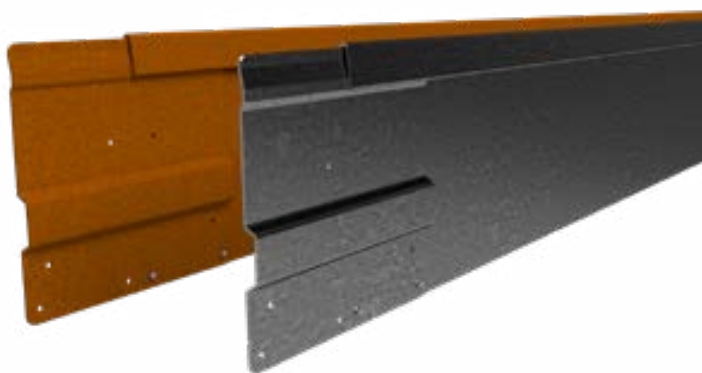

SOLD AS SET INCLUDING

- 1 x Connector plate (pre-attached)
- 3 x Fixing pegs, 300mm long



ADDITIONAL ACCESSORIES

- 500mm Corner piece (250 + 250mm arms, bend to desired angle)
- Hard surface fixing bracket
- Heavy duty peg

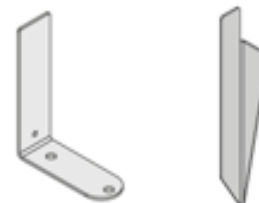

150mm Rigid Installation Guide

Scan or click to watch install video



REQUIRED FIXINGS

- 2 x Tek Screws (12G x 16mm) or
- 2 x pop rivets (4mm shaft)

RECOMMENDED TOOLS

- Ground leveling tools
- Rubber mallet
- Cordless drill and Tek screw bit
- Angle grinder (only required if modifying lengths or fashioning ends)

PREPARATIONS

Mark the intended line on the ground and measure what length of edge is needed. Making a trench to set the edge into may be necessary. This will dictate the amount of edge that finishes proud and visible for your buried edge. For a retrofit, where surrounding heights are set, trench relative to these. For a new garden where surrounding materials may be added, the edge is sometimes installed without a trench, and then materials are filled up to and around it. Either way, burying the edge more deeply adds strength and assists curve support. Consider the 240mm edge if more visibility of edge face is desired.

Note: This edge will allow slight curving. Corners can be made in situ or purchased as accessories.

DO...

- ✔ Use for straight lines or very slight curves
- ✔ Consider the best edge orientation in terms of smooth face/top edge viewing
- ✔ Take care to position pegs exactly in line
- ✔ Use some Flexline lengths if your design has some curved sections, they're compatible!

DON'T...

- ✘ Use for tight curving lines, instead use Flex
- ✘ Forcibly bend. This Rigid will shape gently for a slight curve only
- ✘ Accelerate rust with acids or salts, that's harmful to patina development

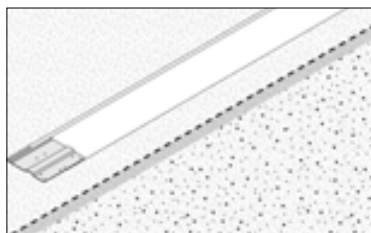

STEP 1 - Mark edge line on ground or by trenching and layout edge pieces.

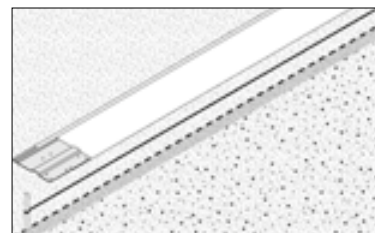

STEP 2 - Be sure trench depth is right and set string line, laser or other method to mark line.

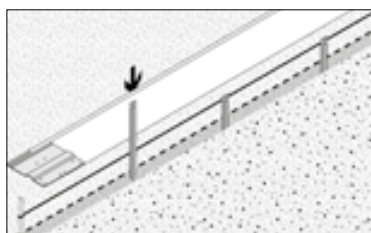

STEP 3 - Evenly space and hammer in pegs (three per length) directly along line to just above finishing height.

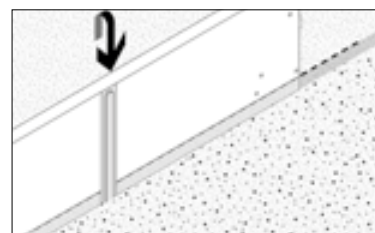

STEP 4 - Place first edge onto first three pegs (start at edge end without a connector plate).

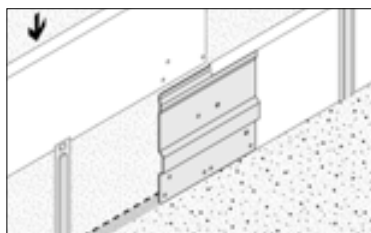

STEP 5 - Place next edge down onto pegs and connector plate of first edge for joining.

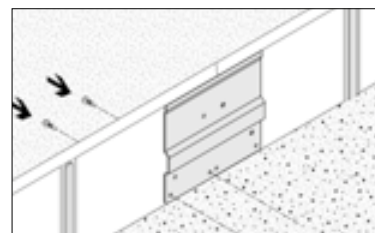

STEP 6 - Secure together with Tek screws through aligned guide holes.

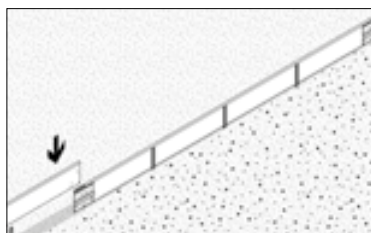

STEP 7 - Introduce further lengths, connecting them as you go along the install line.

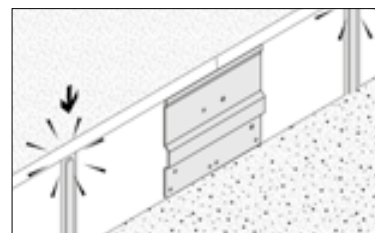

STEP 8 - Once all are in place, use rubber mallet to firmly strike edge so pegs lock in.

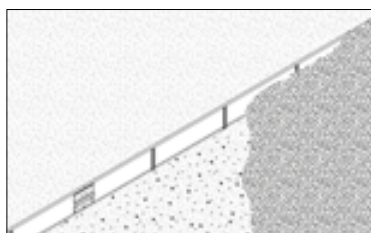

STEP 9 - Then backfill to finish, packing fill around the edge.

CORNERS

Standard corners are available for purchase, but you can choose to make your own. Making your own corners will likely mean less waste, as the corners are simply made where they are needed with no offcuts created.

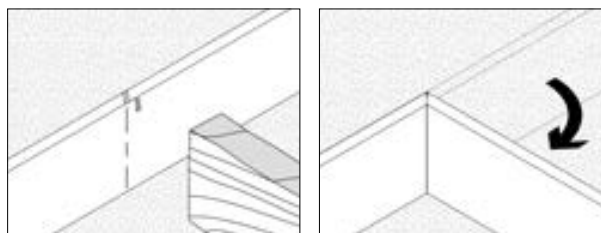

STEP 1 - Score a line down the back of the edge and create a sufficient opening (5-7mm) in the double folded lip at the top.

STEP 2 - Bend by hand. Placing a block of wood close to the fold improves the result.

GEOMETRIC SHAPES

You may look to create the likes of rectangles or squares such as for tree surrounds. To do so measure carefully and create the corners where needed. Alternatively purchase four corners for an exact 500mm square shape.

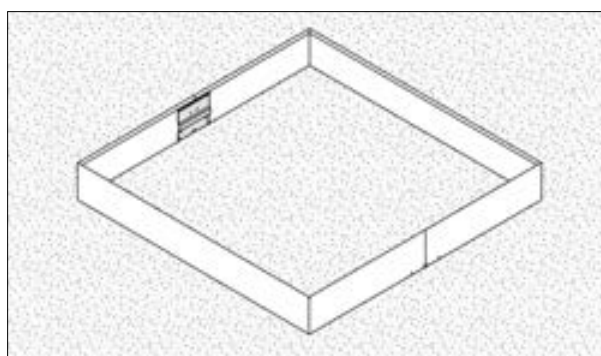

INSTALLING ON HARD SURFACES

Where ground conditions are too hard for standard pegs to penetrate, the heavy duty peg may be used instead. These are first driven into the ground (hammer the hip, not the top part) and then the edge is hammered onto them with a rubber mallet to firmly wedge the heavy duty peg in under the edge rim.

Alternatively the Hard Surface Fixing Bracket may be used. This also wedges firmly in under the edge rim when the edge is hammered onto it with a rubber mallet. This Hard Surface Fixing bracket can be secured through the holes in the foot with galvanised spikes in hard ground or with DynaBolts™ when fixing to concrete. The DynaBolts™ or Fixing spikes utilised do not come with the bracket so need to be acquired separately.

On impermeable surfaces such as concrete, use packers to elevate the edge slightly; allowing drainage away from edge.

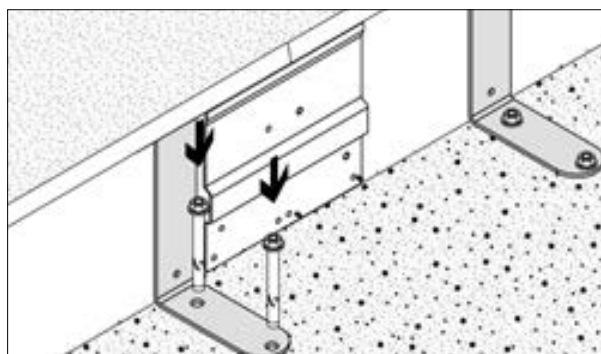
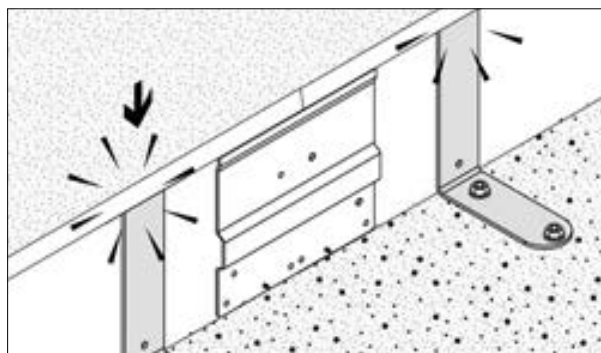

JOINING EDGE TO A SURFACE OR ROCK

A join tab can be made using an angle grinder. This involves cutting away the top lip portion and scoring a fragmented fold line for the remaining tab piece. The tab is then bent as required for fixing and screwing to the surface it joins.

If butting up to a rock, using a diamond tip blade to cut a slot in the rock itself allows the edge to sit into it snugly, or just use the rock to hide the edge end safely behind it.

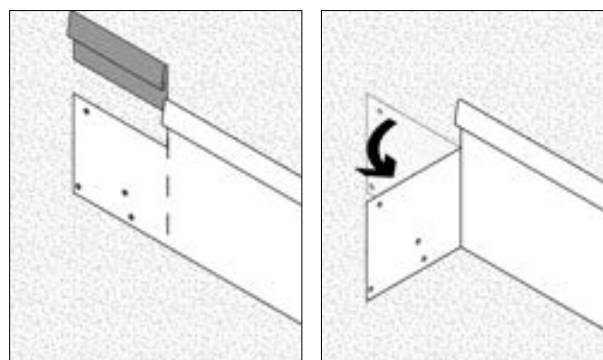

COMPATIBILITY

The 150mm Rigid is compatible with the 150mm Flex, because the joining plates and edge profile are exactly the same. This means you can use both together on the same project!

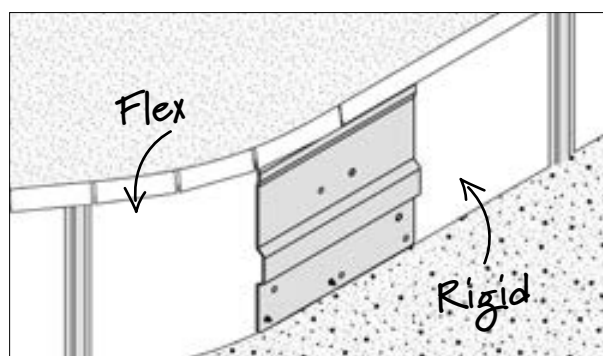

Straightcurve® Zero-Flex Garden Edging - 150mm

HL150WS WEATHERING STEEL | HL150GS GALVANISED STEEL

Product features

The details that make the difference

Connector plate and guide holes for precise and discreet joins



Two-way Continuous Foot for holding straight lines



Double wall and rolled top for structural strength



7mm rounded tops for child and pet safety



Moveable fixing spike for easy obstacle avoidance



EDGE STYLE



FINISHES

- Galvanised Steel
- Weathering Steel

For lasting, perfectly straight unmovable lines

Product specifications

TECHNICAL SPECIFICATIONS

Length (Installed)	2200mm
Top edge thickness	7mm
Steel plate thickness	1.6mm
Weight per length	10kg

BULK BUYING

Pack quantity	18
Bulk pack weight inc. pallet	200kg

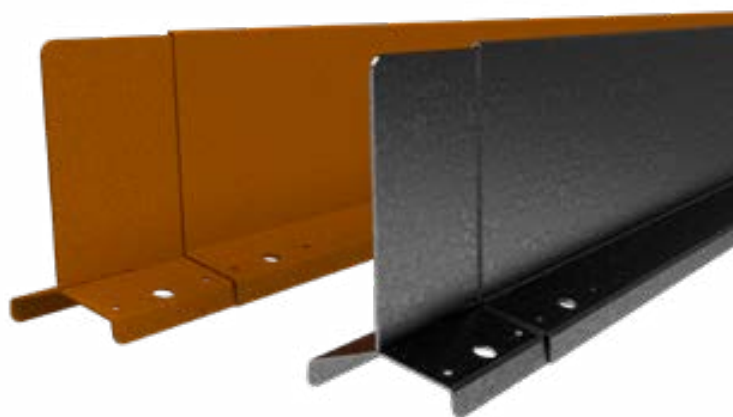

SOLD AS SET INCLUDING

- 1 x Connector plate (pre-attached)
- 4 x Galvanised spikes, 300mm long



ADDITIONAL ACCESSORIES

- 500mm (250mm + 250mm) Corner piece (reversible) (bend to desired angle)

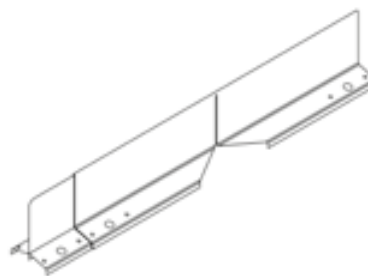

150mm Zero-Flex Installation Guide

Scan or click to watch install video



REQUIRED FIXINGS

- 4 x Tek Screws (12G x 16mm) or
- 4 x pop rivets (4mm shaft)

RECOMMENDED TOOLS

- Ground leveling tools
- Rubber mallet
- Cordless drill and Tek screw bit
- Angle grinder (only required if modifying lengths or fashioning ends)

PREPARATIONS

Mark the intended line on the ground to measure what length of edge is needed.

A firmer, compacted base is best for installing Zero-Flex and may need to be prepared first. This foundation is key for the edges strength and line holding capability.

For a retrofit, where surrounding heights are set, trench relative to these. For a new garden where surrounding materials may be added, the edge is sometimes installed without a trench, and then materials are filled up to and around it. The trench depth dictates the amount of edge that finishes proud and visible. Burying the edge more deeply adds strength, as does having firm flat ground as the foundation.

DO...

- ✓ Pay attention to best ground preparation for a firm foundation
- ✓ Get the depth of trench right the first time
- ✓ Join all lengths and corners in place and perfect the line before finally fixing in position

DON'T...

- ✗ Use all galvanised spikes on one side only
- ✗ Skip the screwing stage, these lock in the seamless join
- ✗ Accelerate rust with acids or salts, that's harmful to patina development
- ✗ Leave a square top corner unsafely protruding at an end, cap or round it off with a grinder instead.

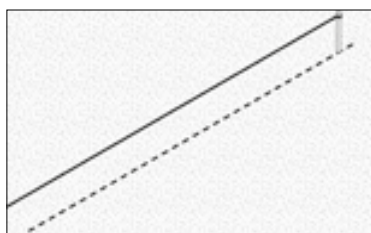

STEP 1 - Use string line or mark edge line on a firm base.

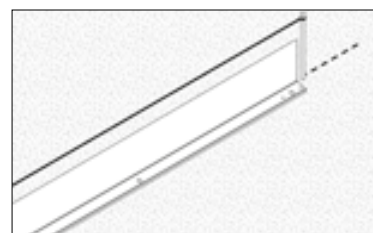

STEP 2 - Position first edges along the desired line.

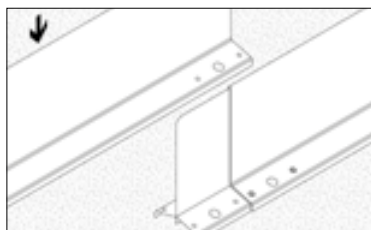

STEP 3 - Slide connector plate of one edge into the next to connect.

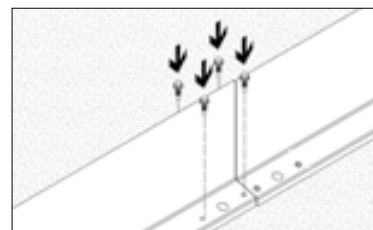

STEP 4 - Secure together with Tek screw through aligned guide holes.

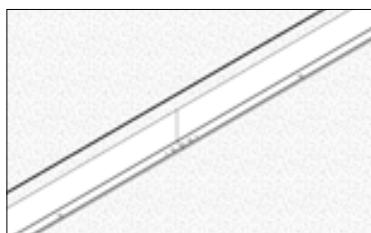

STEP 5 - Introduce further lengths, connecting them as you go along the install line.

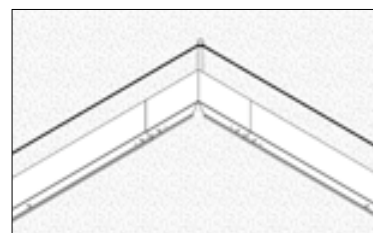

STEP 6 - Form and introduce corners where needed (lengths may need to be cut with grinder).

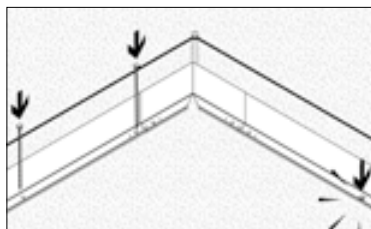

STEP 7 - Check position then hammer four galvanised spikes per length through foot holes, either side and evenly spaced.

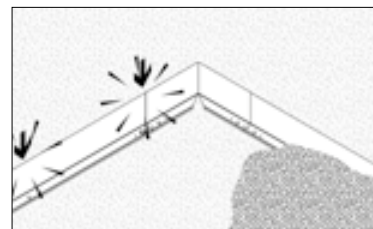

STEP 8 - Firming can be done with the rubber mallet, then backfill to finish

Bonus Tip! When is adding concrete footings a good idea?

For a Zero-Flex install on soft/sandy/shifting ground conditions consider setting the galvanised fixing spikes and the join sections into some concrete. Fill materials on both sides also add strength and can remove the need for concrete, but the foundation the edge sits on is always key to Zero-Flex's strength.

CORNERS

Standard corners are available for purchase, and their direction can be reversed when required by moving the connector plate to the other arm. Alternatively, you can choose to make your own corners. Making your own corners will likely mean less waste, as the corners are simply made where they are needed with no offcuts created.

Suggestion: Purchase one corner, and use that as a template for cutting in corners in other whole lengths where needed.

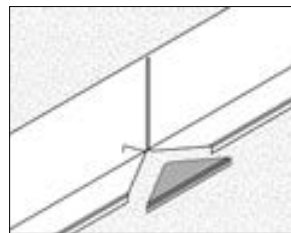

STEP 1 - Cut down the vertical wall (not to the very top) and cut away a V in the shoulder foot (at least 120 degrees) on the side where you will bend it in.

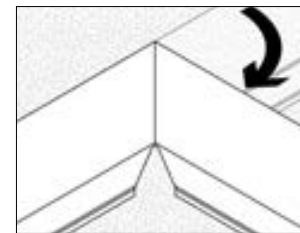

STEP 2 - Make a single cut on the opposing side shoulder (see step 1 diagram) then bend in the corner.

RECTANGLES & SQUARES

To create rectangles or squares be precise with your marking out before cutting. It's possible to join four corner pieces to easily make a 500mm x 500mm square. Similarly corners could be utilised with full lengths or part thereof, to make larger square or rectangular beds.

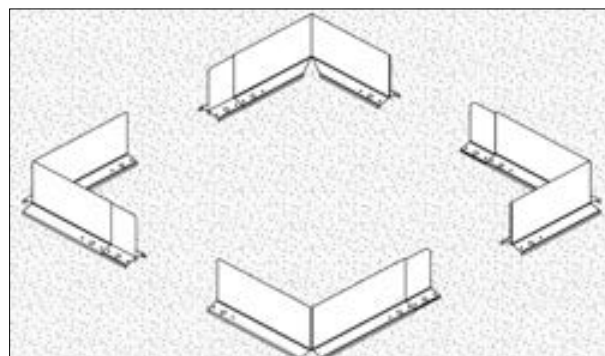

INSTALLING ON HARD SURFACES

The edge can be installed on a hard surface. When the surface is very hard but penetrable, use the galvanised spikes supplied. If the surface is impenetrable, such as with concrete, a bolt down approach (purchase separately) can be applied. Utilise the same fixing holes but use packers to raise the edge slightly to allow drainage away from the edge.

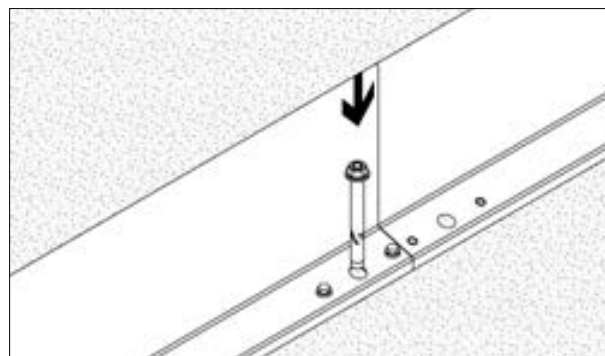

COMPATIBILITY

The Zero-Flex can have the equivalent height Flex product connected to it if a curved section is required. The top profiles are not exactly the same, but very similar when butted together. The Flex connector plate will slot into the Zero-Flex and would then need custom securing down low with some Tek screws.

Where the non-connector plate end of the flexline meets Zero-Flex Garden Edging (see adjacent pics), cut out a lower portion of the Flex edge to allow it to sit neatly onto the Zero-Flex edge connector plate and secure with screws.

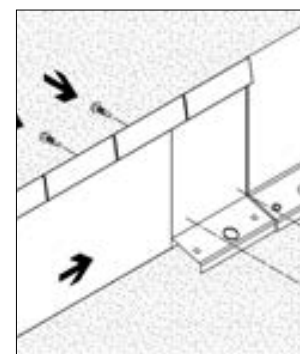
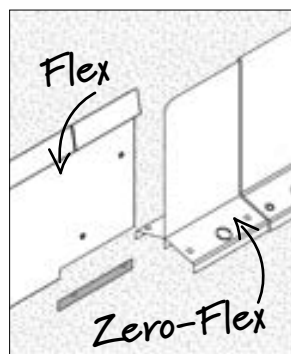

Technical Drawings

75mm

100mm

150mm

240mm

400mm

560mm

Planter boxes

STRAIGHTCURVE® FLEX GARDEN EDGING - 150MM

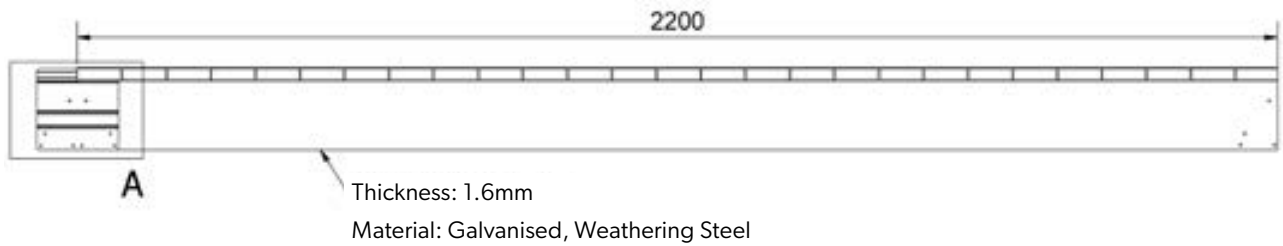

STRAIGHTCURVE® RIGID GARDEN EDGING - 150MM

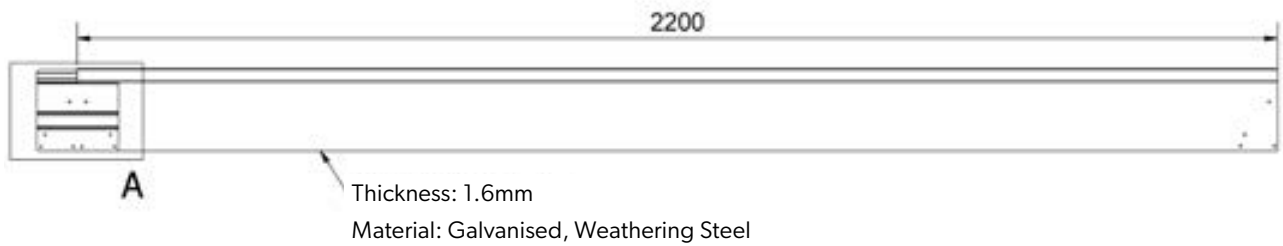

UNIVERSAL SPECIFICATIONS

SIDE PROFILE



CONNECTOR PLATE

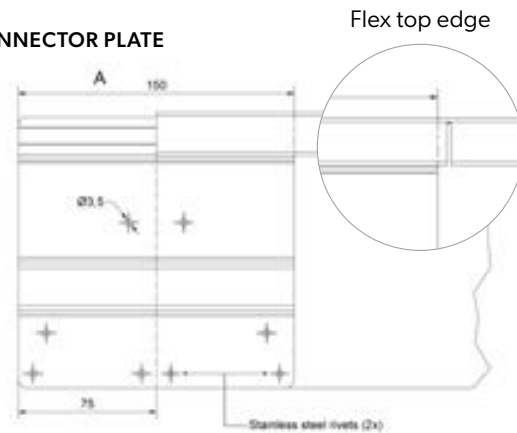

HARD SURFACE FIXING BRACKET

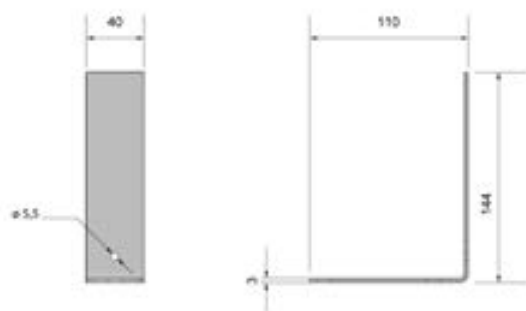

HEAVY DUTY PEG

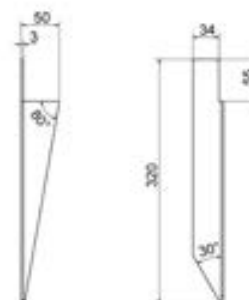



75mm

100mm

150mm

240mm

400mm

560mm

Planter boxes

STRAIGHTCURVE® ZERO-FLEX GARDEN EDGING - 150MM

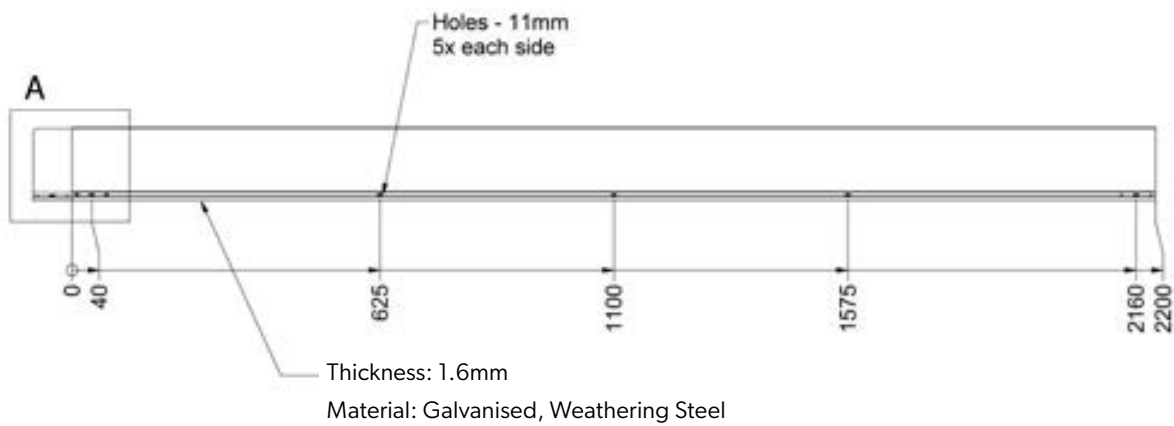

SIDE PROFILE



CONNECTOR PLATE

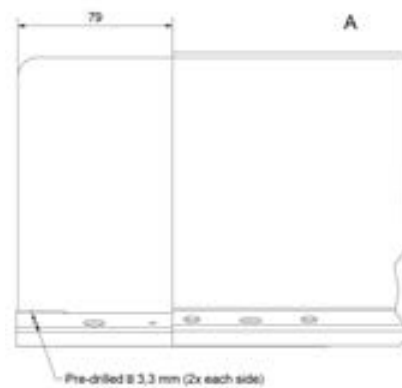

240mm Raised Garden Beds

For curved and straight Raised Garden Bed situations.

Do you know what raised garden bed product is best for your project? Let's figure that out together here!

Use these edges as



RAISED GARDEN BEDS

Raised Garden Bed borders

OR



PATH STEPS & RETAINING

Step faces for paths and slopes

OR



LAWN EDGING

Lawn edge that stands taller

Perhaps it looks something like these?



Straightcurve® Flex Raised Garden Bed - 240mm



Straightcurve® Zero Flex Raised Garden Bed - 240mm

How do you choose the 240mm Raised Garden Bed that's best for you?

We have solutions for curved and straight Raised Garden Bed situations. Use the below table to consider which is the best option from our range for your project. It's your call and we hope these recommendations makes it easier!

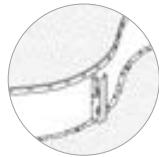
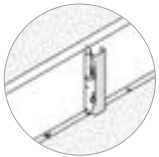
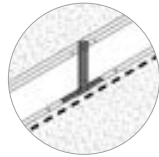
I'm looking for...	We recommend for this ...		
	 Flex - 240	 Rigid - 240	 Zero-Flex - 240
Something I can do myself	✓	✓	✓
A super high-quality raised garden bed that's stylish and strong	✓	✓	✓
Tree rings	✓	✗	✗
Something rigid that helps me to create a straight run	✗	✓	✓
A straight edge that will stay true and won't waver	✗	✗	✓
An edge ideal for linear designs with plenty of corners	✗	✗	✓
Something with a square shaped top edge making it appear boxy	✗	✗	✓

How about this!? It's also possible to combine styles, as our Flex Raised Garden Bed panels and Rigid Raised Garden Bed panels are join and profile compatible.

Product overview

ROUNDED TOPS AND SAFETY FEATURES

The smooth, rounded tops and edges assist safe handling. When installed, all joins/fixings are internal so that the exposed top and front present as a smooth top edge and continuous fascia.

SAFER AND CLEANER HANDLING

We recommend wearing gloves as the manufacturing process can leave residual oils/dust and our products can get hot when exposed to sunlight. Our products are shipped in bundles, when lifting bundles handlers should be mindful of their carrying capabilities. Single items are easy to carry for one person (see product weights).

ABOUT WEATHERING STEEL

The manufacturing process of weathering steel leaves the surface in a dark, almost black state. This dark 'finish' is an oxide layer that forms during the hot rolling process. The weathering process needs to break this layer down first before the desired protective patina layer can be established. You can expect some inconsistency in the patina formation because the thickness of the oxide layer varies; it'll appear spotty with some areas going orange and others still black.

The patina develops naturally with periods of wet and dry, and both phases are key for its steady formation. Do not wet continually without allowing time for thorough drying. A faster patina formation can be aided by cleaning the surface with soapy water to remove oil residue, but anything harsher is not advised as it can be detrimental to patina development and consequently, reduce product lifespan. Some rust solution products are safe to use as these 'build a surface patina' rather than just accelerating rusting.

WHAT IS A PATINA

Patina is not the same as rust. All rust is patina, but not all patina is rust. Patina is a chemical bond between various elements and usually oxygen. It can be found on most metals with the exception of 8 inert (noble) metals like gold or silver. 'Normal' rust is iron-oxide, the patina referred to above is mostly a bond between copper, phosphorus, chromium, nickel, iron and oxygen. You may wonder, how does water feature in it? Water acts as an electrolyte, but

that's a different story. In the end, the patina formed on weathering steel is a dense layer that doesn't flake or allow oxygen through. Therefore, once formed, the oxidation process slows down dramatically.

WILL THE STEEL STAIN MY PAVERS OR DECK?

This can occur in the early stages of rusting but can be avoided with care, such as by protecting nearby surfaces while the patina establishes. The worst cases of this you will see involves mild steel because the rusting carries on unabated. With weathering steel this should only happen when first developing a patina or if rushed artificially (sped up with acids/salts) to achieve faster colour change. What you can do as an excellent strategy is pre-rust the edging before installing to have a stable early phase patina there already. This doesn't need to take long if you procure a rust solution recommended for stable patina formation.

LONGEVITY

Our products are of the highest quality ensuring longevity in the given environment. For further information please refer to the "Longevity Guide" and "Product Care Guide" on our website.

PAINTING, SEALING AND POWDERCOATING

Our galvanised products are suited to painting, but the surface should be thoroughly prepared (using acetone wash), and sealed with a metal primer (etch primer is very good) to maximise topcoat adhesion.

Powdercoating is a much more durable/hardy choice, and can be requested for large projects with lead times/costings supplied. It is worth noting that not all powdercoating performs the same, we use and recommend Interpon powder from AkzoNobel for assured quality and maximum endurance and suggest you request the same. It's also worth asking first to see a sample from your chosen powdercoater specialist. Note that, as for painting, galvanised products should be used whenever powdercoating.

75mm

100mm

150mm

240mm

400mm

560mm

Planter boxes

Another question we get relates to freezing the colour (or patina development) at a certain stage. That's possible using a transparent sealant suitable for steel. Keep in mind that the colour will change when applying a sealant, it'll get a 'wet' look. Be sure to test this in a small inconspicuous area first before fully committing. This will require reapplication once a year.

WHEN IS CONCRETING AROUND THE ANCHORS AND FIXING SPIKES NECESSARY?

For an install on sandy/soft/shifting ground conditions, consider setting the foot-stabilising galvanised spikes and stakes or bracing anchors into some concrete for extra hold. The firmness of the subsurface ground when the spikes are hammered in is the best indicator as to whether this is needed; they need to gain purchase and feel rigid. The 240mm Raised Garden Beds typically do not experience a great outward force, so in the majority of cases concrete is not required.

However, if the edge is performing as a step front it's worth using the Universal Bracing Set (instead of the small anchor posts) with the anchoring stake concreted in for a sturdier step retainer.

HOW TO POSITION THE EDGE

These Raised Garden Beds have a front facing side with discreet join seams, it's designed to show the full face with no need to dig it in (courtesy of the grounding feet). The back side retains the actual garden fill so all joins and bracing systems are hidden.

Be mindful also that a garden bed can settle at lower than the install levels and may require topping up later to maintain the look initially achieved with your Raised Garden Bed. This top up practice can also increase lifespan, as the protective patina formation may be inconsistent in previously buried portions.

HOW DEEP DO I BURY THE EDGE?

For all these products there is no need to bury the edge. Traditionally, it has been necessary to do so when using steel panels for raised beds, but the lockdown foot feature these edges possess has eliminated the need for this practice of burying the edge by one third. You effectively get the same result as the old ways, with a third less steel!

Sometimes these products are used as a partly buried garden edge, with the additional height allowing the edge to show more face or raise a bed just slightly higher than the surrounding level.

WHY DO WE SUPPLY AND RECOMMEND TEK SCREWS?

When fixing the edge stakes to the bracing ribs or the edge fixing lip to the small anchor post we use Tek screws for their self-tapping (self-drilling) abilities. This is an easy, fast and strong method. The long lasting, grey Dacromet Tek screws are best for all the buried screw locations of these products.

ADVANTAGES

- ✓ Continuous smooth top square or rounded edges
- ✓ Corners available or easily made in situ
- ✓ Up to 3x faster installation
- ✓ No welding required
- ✓ No Experience/training needed
- ✓ Designed for ease of use

Straightcurve® Flex Raised Garden Bed Panel - 240mm

FL240WS WEATHERING STEEL | FL240GS GALVANISED STEEL

Product features

The details that make the difference

Wedge and slider join system for a faster, stronger no weld method

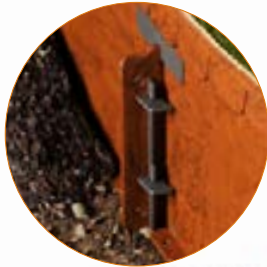

Full face visible instead of burying the edge. Discreet join seams for a stylish finish



Moveable fixing spikes for easy obstacle avoidance



Ribs and anchor posts for strong vertical staking



Notched Top and Foot for smooth, even curves



8mm rounded tops for child and pet safety

EDGE STYLE



FINISHES

- Galvanised Steel
- Weathering Steel

For smoothly curving Raised Garden Beds that look great and hold position once shaped & installed.

Product specifications

TECHNICAL SPECIFICATIONS

Length (Installed)	2160mm
Top edge thickness	8mm
Steel plate thickness	2mm
Weight per length	10kg

BULK BUYING

Pack quantity	30
Bulk pack weight inc. pallet	320kg

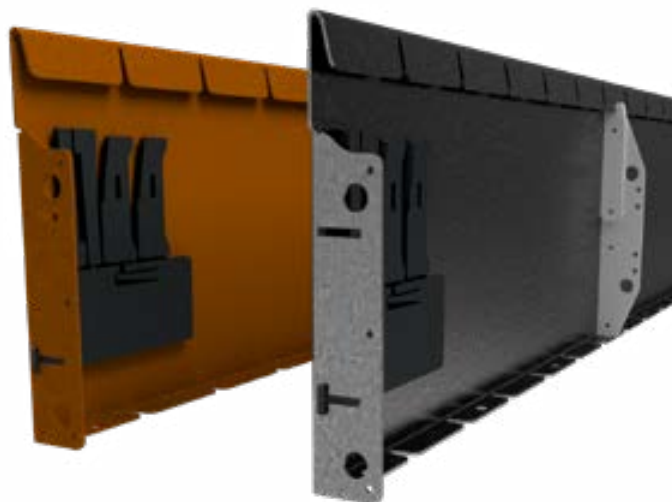

SOLD AS SET INCLUDING

- Joining set includes 1 X join bracket (A), 2 x slider (B), 2 x wedge (C)
- 5 x Fixing spikes, galvanised, 300mm long
- 2 x bracing ribs (attached to edge)

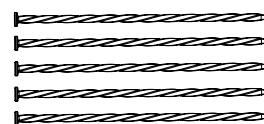
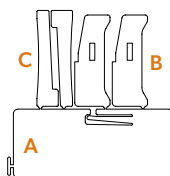

ADDITIONAL ACCESSORIES

REQUIRED

- D** Ground anchor post 470mm, use 2 per length (Tek screws required)

OPTIONAL

- E** Corner piece (90 degree right angle/arm lengths: 255mm)
- F** Reverse corner piece (270 degree L-shape/arm lengths: 255mm)
- G** Universal bracing set as ground anchor post alternative (turnbuckle/cable or chain/T-stake)
- H** Join Part for Offcuts (Tek screws required)



D

G

H

Flex Raised Garden Bed Panel - 240mm Installation Guide

Scan or click to watch install video



REQUIRED FIXINGS

- Ground anchor post
2 x Tek Screws (12G x 16mm)
- Join part for offcuts
6 x Tek Screws (12G x 16mm)

RECOMMENDED TOOLS

- Ground leveling tools
- Metal hammer
- Rubber mallet
- Cordless drill and Tek screw bit (for accessories **D** and **H**)
- Angle grinder (required if modifying lengths or fashioning corners/ends)

PREPARATIONS

The Flex Raised Garden Bed requires NO digging in as its feet are secured to the ground surface. The base should be smoothed/ leveled for the edge to sit flush on the ground during installation. Any obstructions should be removed or re-routed. It can be installed on all level ground types including concrete surfaces (where packers are used to sit edge off ground to allow drainage). It is useful to have some cardboard or board to place under joins when connecting with the panel face down on flat ground. Grass and debris likes to get caught in the tight seam!

DO...

- ✓ Join all lengths in place and perfect the line before finally fixing in position.
- ✓ Use the rubber mallet (not metal hammer) when hammering top edge
- ✓ Start from corner if using a pre-made one
- ✓ Score an intermittent line rather than one deep score line if making corners.
- ✓ Follow the instructions carefully and do it with a friend if making a two panel ring
- ✓ For circular beds backfill evenly for equal outward pressure

DON'T...

- ✗ Use for straight lines, instead use Rigid or Zero-Flex options
- ✗ Forcibly bend. Take care and gently flex the edge to shape
- ✗ Forget to stake or brace your edge once joined (unless a circle of four lengths or less)
- ✗ Accelerate rust with acids or salts (but soapy water is ok!)
- ✗ Leave a square top corner unsafely protruding at an end, cap or round it off with a grinder instead.

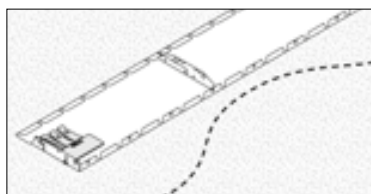

STEP 1 - Mark edge line on ground and layout edge pieces nearby.

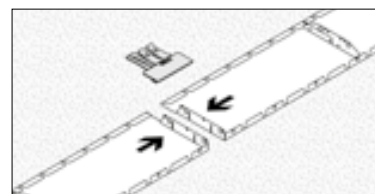

STEP 2 - Place first two edges front face down on the ground with ends touching and with join slots aligned.

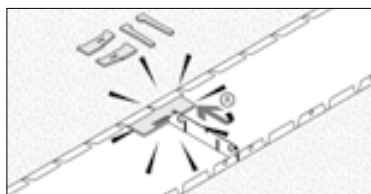

STEP 3 - Join using the joining set, break the pieces apart first by hand and insert join bracket (**A**) securely under the top lip of panels (use a metal hammer to firmly lock in).

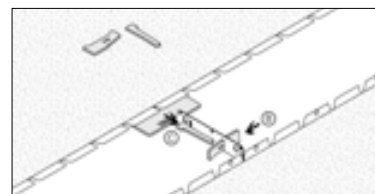

STEP 4 - Next, insert a slider (**B**) through adjacent bottom slots with its 'feet' against the edge. Knock it through fully so wedge (**C**) can insert and lock in the slider.

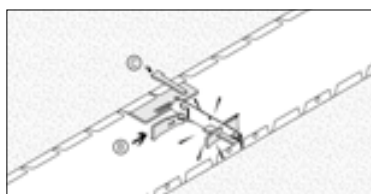

STEP 5 - Hammer the wedge in firmly. Repeat step 4 for top slot using the remaining wedge and slider.



STEP 6 - Set these two edges upright and flex to position where desired, use fixing spikes as temporary placeholders.

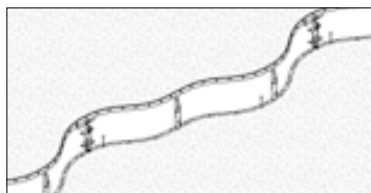

STEP 7 - Introduce and join further lengths (or joined pairs of lengths), butting them against the now standing edge, connecting them as you go.

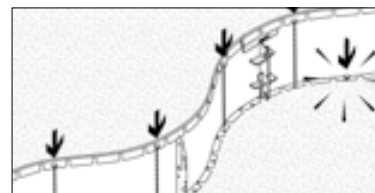

STEP 8 - Check the line, then hammer all fixing spikes (5 per length) through foot tab holes.



STEP 9 - To Stake, hammer the ground anchor post in tightly adjacent to a bracing rib and close against the bottom foot.

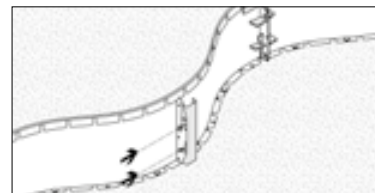

STEP 10 - Screw the ground anchor post to the bracing ribs with tek screws through guide holes.



STEP 11 - Back fill your Raised Garden Bed to finish.

75mm

100mm

150mm

240mm

400mm

560mm

Planter boxes

Creating corners

PRE-MADE CORNERS

Pre-made corners with 255mm long arms are available for purchase and include the standard joining set. There is a standard 90 degree right angle corner and a reverse corner for turn backs such as when making an L-shape. It's difficult, but the angle of these pre-made corners can be adjusted by applying considerable force using ratchet straps or other means.

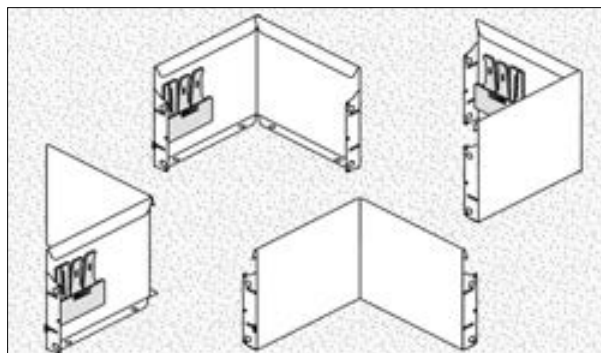

MAKING YOUR OWN CORNERS

To make a corner yourself you will need to use an angle grinder. Be sure to operate safely with all suitable gear.

1. Mark a vertical line down the back of the edge directly beneath a top edge notch space where the corner fold is needed. With the angle grinder score the line in three places sufficiently to create a fold line.
2. Also cut a gap in the top lip and remove a bottom foot tab on one side of the fold line to allow room for bending in.
3. Bend strongly by hand; using a block of wood close to the fold to form the bend against helps.

For reverse corners (~270°) a fold line will need to be cut in as above. Also raise the height of the notch groove to the top of the lip neatly to aid the bend. No other cuts are required.

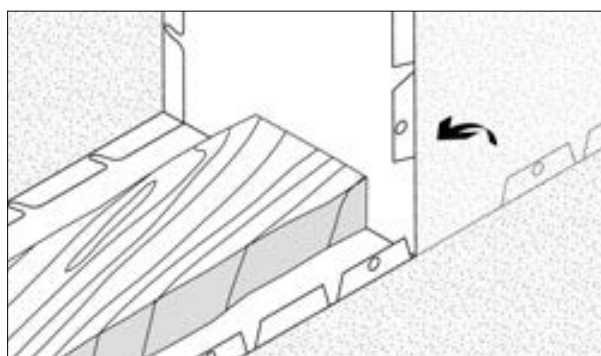
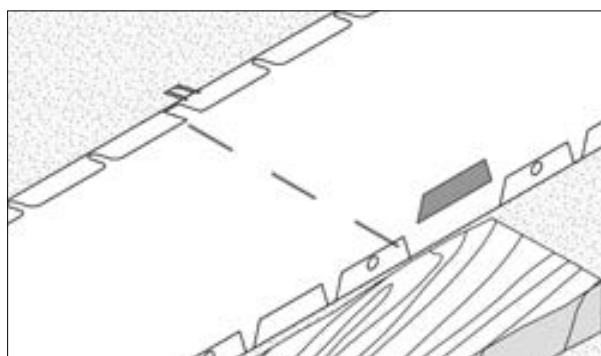

Creating circles

CIRCLES & CURVE CAPABILITIES

Connecting edge panels makes standard ring sizes. Design for complete edge lengths of 2 or more to give the desired diameter. Here's our standard sizes.

Standard Circle diameters

No. of panels:	2	3	4	5
Diameter:	1.37m	2.06m	2.75m	3.44m

In terms of curve capabilities, the 240mm Flex Raised Garden Bed Panel has a minimum radius achievable of around 700mm. It is designed to allow this degree of flex and no more. This is also why you cannot make a ring with one panel, the two panel ring is the smallest possible. If the Raised Garden Bed face makes a concave curve the back of the join flanges can gap slightly. To counter this, there are some pilot holes at the back edge of the join flange. Screw through these with Tek screws before creating the concave curve.

HOW TO MAKE A TIGHT CIRCLE (D:1370MM) WITH TWO EDGE PANELS.

Require 5m ratchet strap and sturdy rectangular board (recommend 600-1200mm wide X edge height).

This construction is best done with two people.

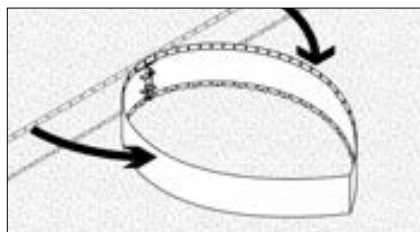

STEP 1 - Connect two panels with joining set, then pull ends in to meet in teardrop shape.

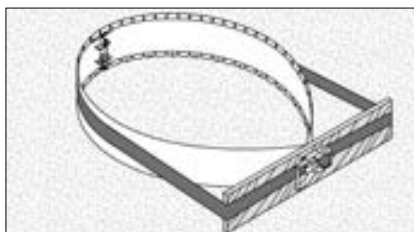

STEP 2 - Place ratchet strap around midriff and over the board, with the board positioned to pull in open end.

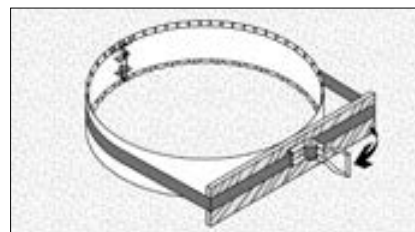

STEP 3 - Ratchet in until ends are flush, and fully align join flanges with gradual ratcheting.

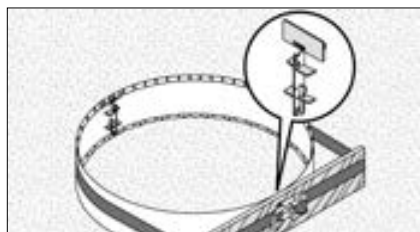

STEP 4 - When the edge end join flanges align perfectly, use joining set to lock together.

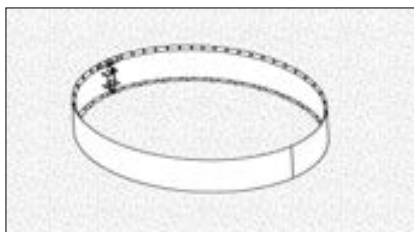

STEP 5 - Release ratchet and unstrap, it will be slightly oval in shape.

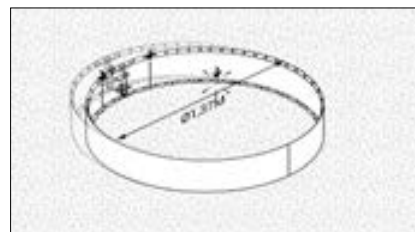

STEP 6 - Correct to desired ring shape, measuring diameter (1.37m) and pin the feet to hold as you go.

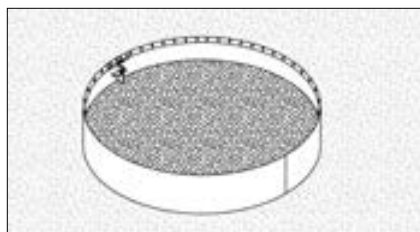

STEP 7 - That done, fill evenly, there is no need for bracing this self supporting circle.

Note: For three or more panels, two people can simply pull into shape and connect, without the need for ratchet approach

Bracing methods

BRACING ON VARIOUS HARD SURFACES

The 470mm ground anchor posts will not be strong enough to penetrate some surfaces. In these situations use the Universal Bracing Sets by fitting the turnbuckle with cable or chain to the pre-fitted bracing ribs and anchoring back to the ground.

1. The stake that comes with the Universal Bracing Set is of a star picket style and will penetrate very hard surfaces, as do the fixing spikes that lock in the feet.
2. On concrete, a bolt down method can be used in place of the stake, anchoring the chain with a DynaBolt™. Bolt the foot tab holes in place with an 8mm DynaBolt™, but first introduce packers to raise it slightly for drainage.

TIP: When using the Universal Bracing Sets, securing the anchor point to alternative structures such as walls or fences is also a workable solution.

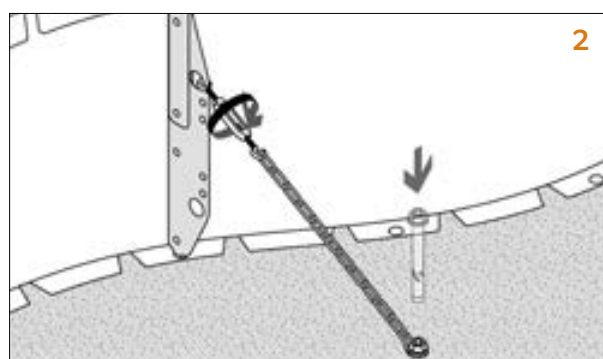
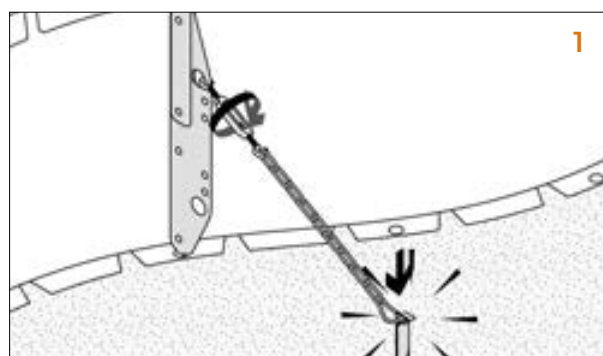

HOW TO MOVE A BRACING RIB

It's easy to move the bracing rib if it is located above an obstacle preventing staking there or where access to the rib will be difficult. Simply loosen and remove the bracing rib by knocking it sideways near the top with a hammer. It can then be refitted in a new place, inserting the base nub into a bottom foot tab hole first, and then tapping the upper part of the bracing rib with a hammer firmly to return it to a vertical position tight behind the top lip.

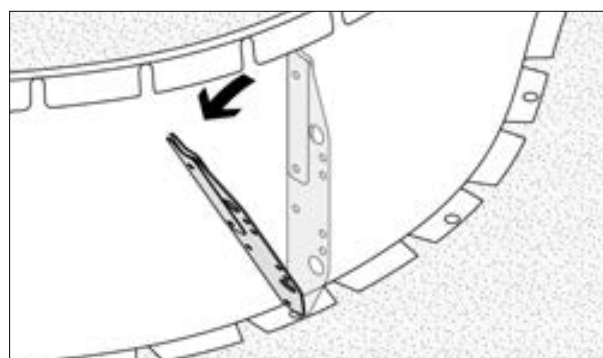

CREATING CONNECTION TABS OF YOUR OWN

To fix one end to a wall or other solid feature you can fix the folded back flange on the end of the panel to that surface. Simply bolt or screw as appropriate to fix it strongly.

If the edge panel is too long to do that, you can both shorten and create a join tab at the same time with your angle grinder. To do so measure carefully first, then remove the extra top lip portion and create the fold back piece by the score and bend method as shown. The tab can then be screwed internally to the surface it meets, which is sometimes another piece of Straightcurve®!

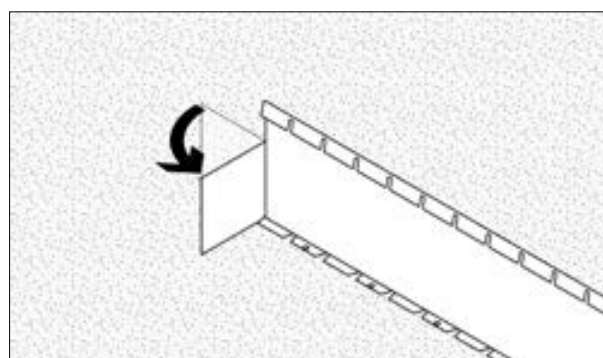
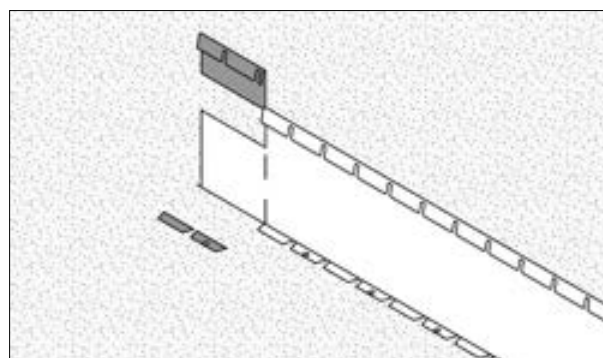

COMPATIBILITY AND WORKING ON SLOPES

1. The 240mm Flex Raised Garden Bed Panel is compatible with the 240mm Rigid Raised Garden Bed Panels. This allows them to work in combination.
2. In fact, join slots align across all Flex or Rigid panels (240/400/560mm) so that a continuous top edge occurs if different heights are joined together. This across height compatibility can be used to advantage with Raised Garden Beds on a slope. On the lower part of the slope the Raised Garden Bed run may need taller panels with a greater edge face visible due to the slope falling away, with panels of lesser height required further up the bank. It takes some careful planning, but can look very effective, adding volume and height to a bed while reducing the amount of steel used in the project overall.

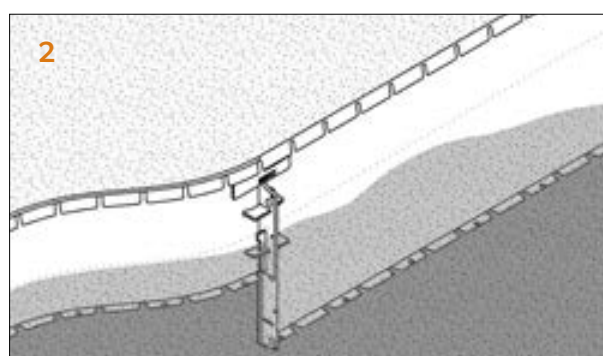
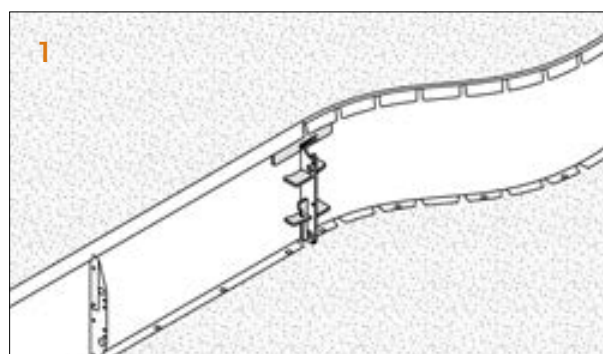

HOW TO USE A CUTBACK PANEL

When a panel is shortened with an angle grinder it loses the join flange. To solve that problem we have a Join Part For Offcuts. This is simply screwed to the cutaway end (through guide holes in join part) and overlays the length it is joining. Further screwing sees both panels neatly connected.

This overlay Join Part does mean screws are visible on the face of the Raised Garden Bed, but it is helpful with perimeters that require a part length to meet or when making regular shaped beds where the side length is predetermined. It also means no offcuts are wasted!

Some tips here are to either place the join part in the least conspicuous spot and use Zinc Screws which blend in as they rust over (for Weathering Steel), or make a feature of it by adding more Join Parts to create a pattern. With that approach, you may even choose to substitute polished bolt heads in place of the discreet screws.

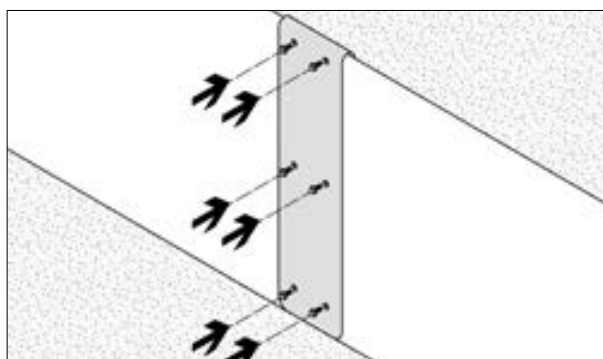
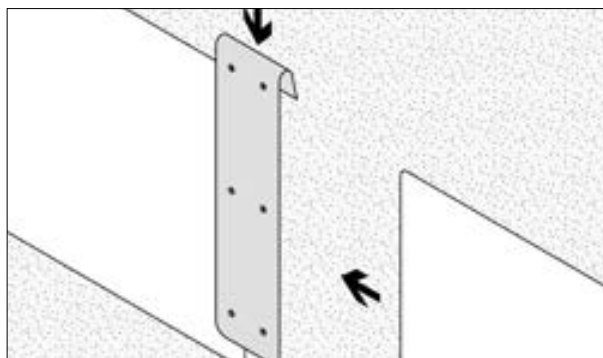

75mm

100mm

150mm

240mm

400mm

560mm

Planter boxes

Straightcurve® Rigid Raised Garden Bed Panel - 240mm

RL240WS WEATHERING STEEL | RL240GS GALVANISED STEEL

Product features

The details that make the difference

Wedge and slider join system for a faster, stronger no weld method

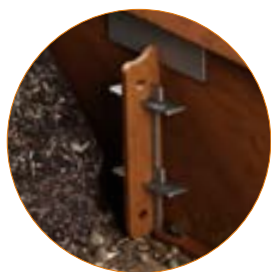

Full face visible instead of burying the edge. Discreet join seams for a stylish finish

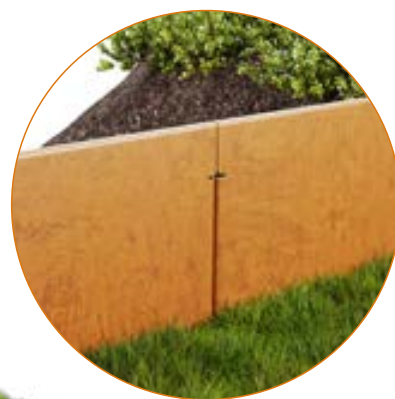

Moveable fixing spikes for easy obstacle avoidance



Continuous Fold Top and Foot for rigid straight lines

8mm rounded tops for child and pet safety



Ribs and anchor posts for strong vertical staking



EDGE STYLE



FINISHES

- Galvanised Steel
- Weathering Steel

For Raised Garden Beds with straight edges

Product specifications

TECHNICAL SPECIFICATIONS

Length (Installed)	2160mm
Top edge thickness	8mm
Steel plate thickness	2mm
Weight per length	10kg

BULK BUYING

Pack quantity	30
Bulk pack weight inc. pallet	320kg

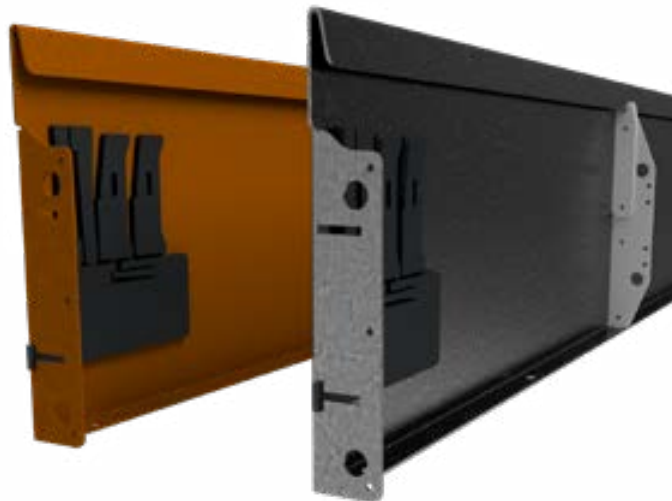

SOLD AS SET INCLUDING

- Joining set includes 1 X join bracket (A), 2 x slider (B), 2 x wedge (C)
- 5 x Fixing spikes, galvanised, 300mm long
- 2 x bracing ribs (attached to edge)

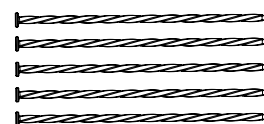
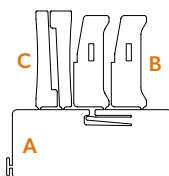

ADDITIONAL ACCESSORIES

REQUIRED

- D** Ground anchor post 470mm, use 2 per length (Tek screws required)

OPTIONAL

- E** Corner piece (90 degree right angle/arm lengths: 255mm)
- F** Reverse corner piece (270 degree L-shape/arm lengths: 255mm)
- G** Universal bracing set as ground anchor post alternative (turnbuckle/cable or chain/T-stake)
- H** Join Part for Offcuts (Tek screws required)

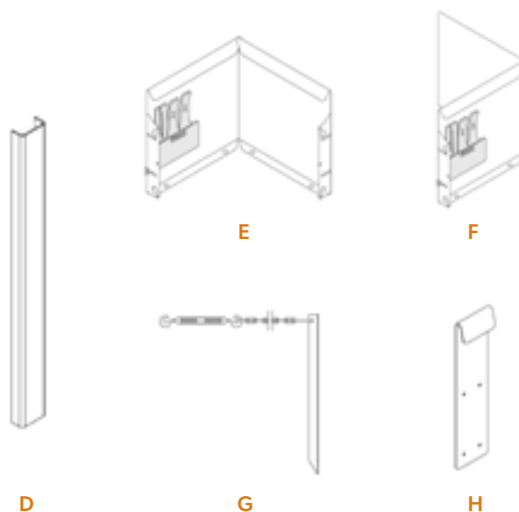

Rigid Raised Garden Bed Panel - 240mm Installation Guide

Scan or click to watch install video



REQUIRED FIXINGS

- Ground anchor post
2 x Tek Screws (12G x 16mm)
- Join part for offcuts
6 x Tek Screws (12G x 16mm)

RECOMMENDED TOOLS

- Ground leveling tools
- Metal hammer
- Rubber mallet
- Cordless drill and Tek screw bit (for accessories **D** and **H**)
- Angle grinder (required if modifying lengths or fashioning corners/ends)

PREPARATIONS

The Rigid Raised Garden Bed requires NO digging in as its feet are secured to the ground surface. The base should be smoothed/ leveled for the edge to sit flush on the ground during installation. Any obstructions should be removed or re-routed. It can be installed on all level ground types including concrete surfaces (where packers are used to sit edge off ground to allow drainage). It is useful to have some cardboard or board to place under joins when connecting with the panel face down on flat ground. Grass and debris likes to get caught in the tight seam!

DO...

- ✓ Check the line with a string line as you add more panels.
- ✓ Start from the corner if using a pre made one
- ✓ Score an intermittent line rather than one deep score line if making corners.
- ✓ Follow the instructions and do it with a friend If making a two panel ring
- ✓ Stake strongly when using for steps

DON'T...

- ✗ Use for curved line designs, instead use Flex Raised Garden Bed
- ✗ Forcibly bend if aiming for a mild curve of a radius exceeding 26m
- ✗ Forget to stake or brace your edge once joined
- ✗ Accelerate rust with acids or salts (but soapy water is ok!)
- ✗ Leave a square top corner unsafely protruding at an end, cap or round it off with a grinder instead.

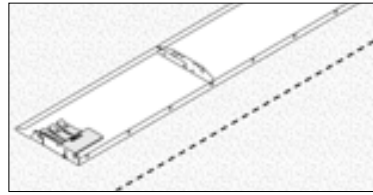

STEP 1 - Mark edge line on ground and layout edge pieces nearby.

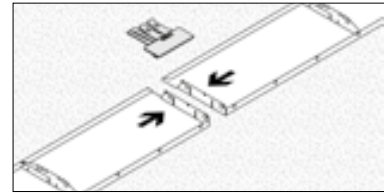

STEP 2 - Place first two edges front face down on the ground with ends touching and aligned.

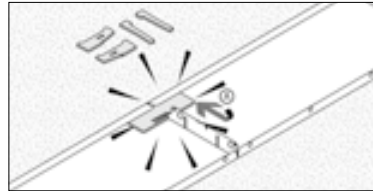

STEP 3 - Join using the joining set, break the pieces apart first by hand and insert join bracket (**A**) securely under the top lip (centered). Press it against back of panels (use a metal hammer to firmly lock in)

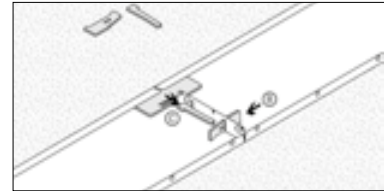

STEP 4 - Next, insert a slider (**B**) through adjacent bottom slots with its 'feet' against the edge. Knock it through fully so wedge (**C**) can insert and lock in the slider.

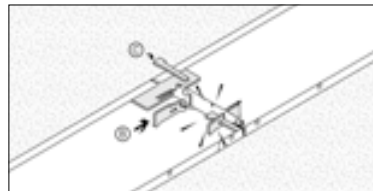

STEP 5 - Hammer the wedge in firmly. Repeat step 4 for top slot using the remaining wedge and slider.

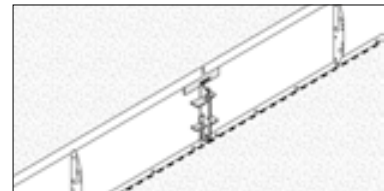

STEP 6 - Set these two edges upright and position where desired.

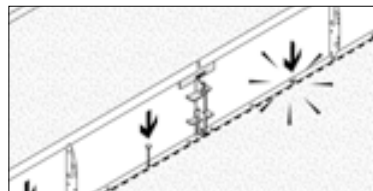

STEP 7 - Check the line, then hammer all fixing spikes (5 per length) through foot tab holes.

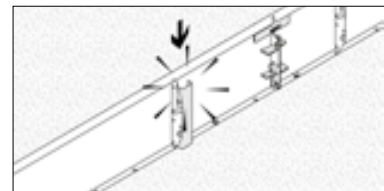

STEP 8 - To Stake, hammer the ground anchor post in tightly adjacent to a bracing rib and close against the bottom foot, finishing below the height of the rolled lip.

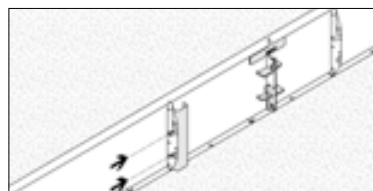

STEP 9 - Screw the ground anchor post to the bracing ribs with tek screws through guide holes.

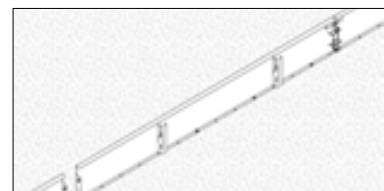

STEP 10 - Introduce further lengths (or joined pairs of lengths), butting them against the now standing edge and connecting them as you go.

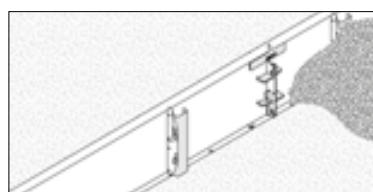

STEP 11 - Back fill your Raised Garden Bed to finish.

Creating corners

PRE-MADE CORNERS

Pre-made corners with 255mm long arms are available for purchase and include the standard joining set. There is a standard 90 degree right angle corner and a reverse corner for turn backs such as when making an L-shape. It's difficult, but the angle of these pre-made corners can be adjusted by applying considerable force using ratchet straps or other means.

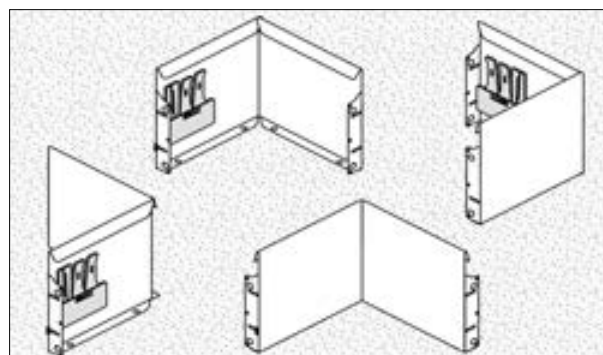

MAKING YOUR OWN CORNERS

To make a corner yourself you will need to use an angle grinder. Be sure to operate safely with all suitable gear.

1. Mark a vertical line down the back of the edge where the corner fold is needed. With the angle grinder score the line in three places sufficiently to create a fold line.
2. Also cut a gap in the top lip and remove a bottom foot tab on one side of the fold line to allow room for bending in.
3. Bend strongly by hand; using a block of wood close to the fold to form the bend against helps.

For reverse corners (~270°) a fold line will need to be cut in as above. Also neatly cut a groove in the top back lip and foot to aid the bend.

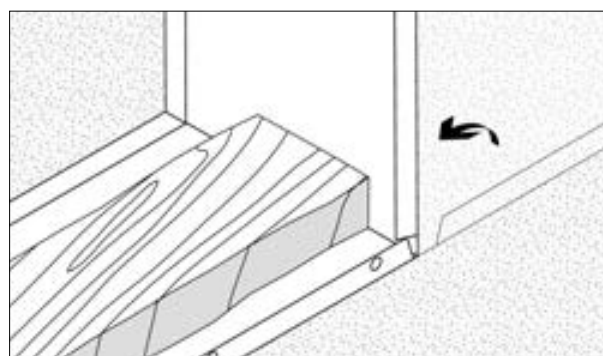
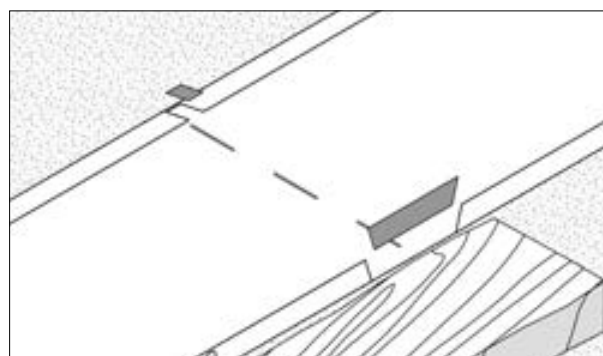

Bracing methods

BRACING ON VARIOUS HARD SURFACES

The 470mm ground anchor posts will not be strong enough to penetrate some surfaces. In these situations use the Universal Bracing Sets by fitting the turnbuckle with cable or chain to the pre-fitted bracing ribs and anchoring back to the ground.

1. The stake that comes with the Universal Bracing Set is of a star picket style and will penetrate very hard surfaces, as do the fixing spikes that lock in the feet.
2. On concrete, a bolt down method can be used in place of the stake, anchoring the cable or chain with a DynaBolt™. Bolt the foot holes in place with an 8mm DynaBolt™, but first introduce packers to raise it slightly for drainage.

TIP: When using the Universal Bracing Sets, securing the anchor point to alternative structures such as walls or fences is also a workable solution.

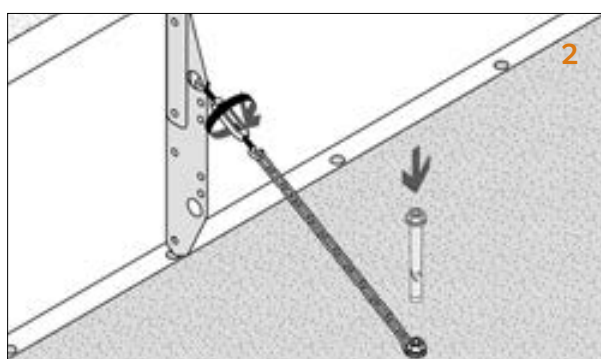
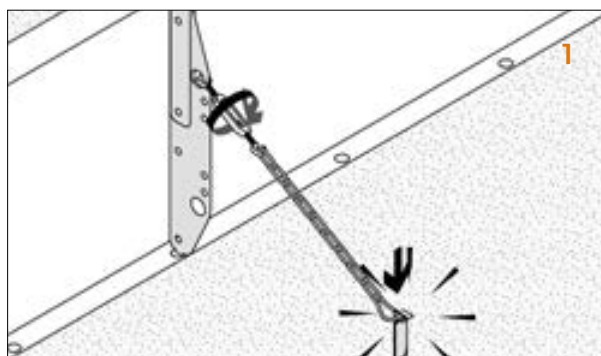

HOW TO MOVE A BRACING RIB

It's easy to move the bracing rib if it is located above an obstacle preventing staking there or where access to the rib will be difficult. Simply loosen and remove the bracing rib by knocking it sideways near the top with a hammer. It can then be refitted in a new place, inserting the base nub into a bottom foot tab hole first, and then tapping the upper part of the bracing rib with a hammer firmly to return it to a vertical position tight behind the top lip.

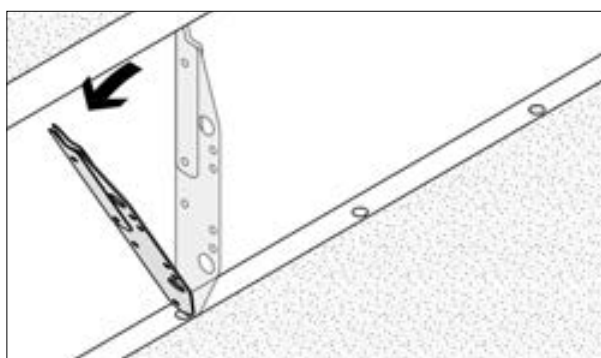

CREATING CONNECTION TABS OF YOUR OWN

To fix one end to a wall or other solid feature you can fix the folded back flange on the end of the panel to that surface. Simply bolt or screw as appropriate to fix it strongly.

If the edge panel is too long to do that, you can both shorten and create a join tab at the same time with your angle grinder. To do measure carefully first, then remove the extra top lip portion and create the fold back piece by the score and bend method as shown. The tab can then be screwed internally to the surface it meets, which is sometimes another piece of Straightcurve®!

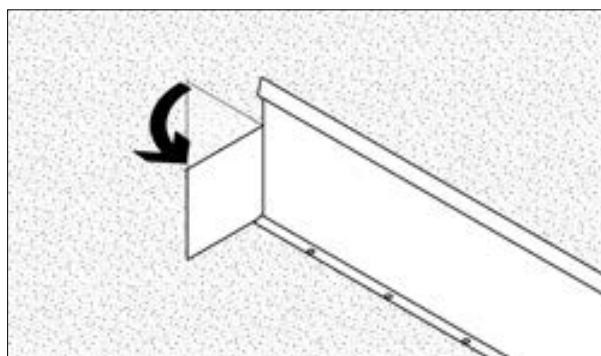
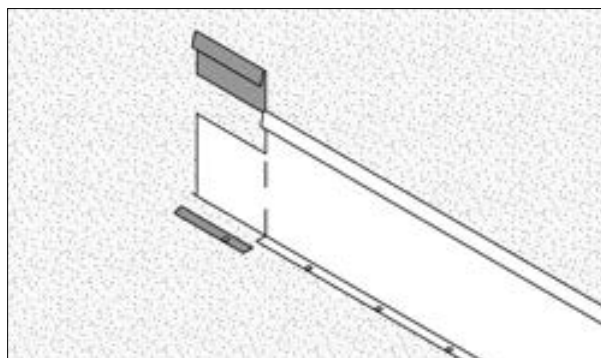

COMPATIBILITY AND WORKING ON SLOPES

1. The 240mm Rigid Raised Garden Bed Panel is compatible with the 240mm Flex Raised Garden Bed Panels. This allows them to work in combination.
2. In fact, join slots align across all Rigid or Flex panels (240/400/560mm) so that a continuous top edge occurs if different heights are joined together. This across height compatibility can be used to advantage with Raised Garden Beds on a slope. On the lower part of the slope the Raised Garden Bed run may need taller panels with a greater edge face visible due to the slope falling away, with panels of lesser height required further up the bank. It takes some careful planning, but can look very effective, adding volume and height to a bed while reducing the amount of steel used in the project overall.

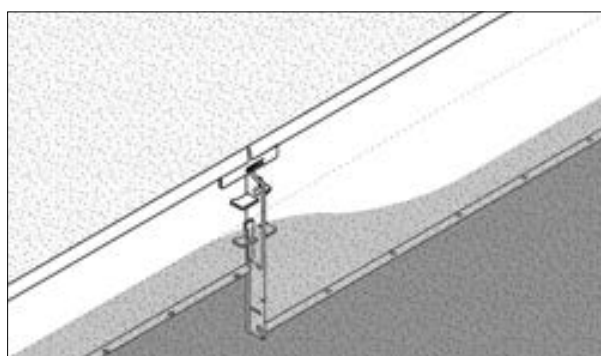
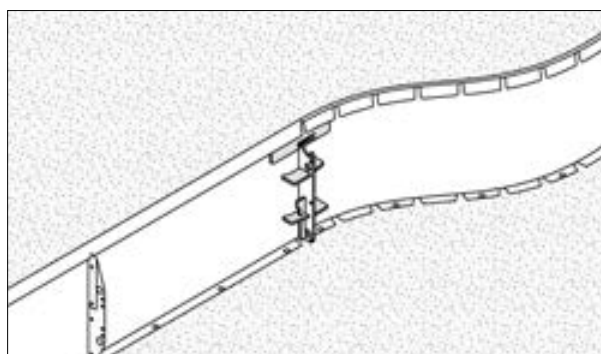

HOW TO USE A CUTBACK PANEL

When a panel is shortened with an angle grinder it loses the join flange. To solve that problem we have a Join Part For Offcuts. This is simply screwed to the cutaway end (through guide holes in join part) and overlays the length it is joining. Further screwing sees both panels neatly connected.

This overlay Join Part does mean screws are visible on the face of the Raised Garden Bed, but it is helpful with perimeters that require a part length to meet or when making regular shaped beds where the side length is predetermined. It also means no offcuts are wasted!

Some tips here are to either place the join part in the least conspicuous spot and use Zinc Screws which blend in as they rust over (for Weathering Steel), or make a feature of it by adding more Join Parts to create a pattern. With that approach, you may even choose to substitute polished bolt heads in place of the discreet screws.

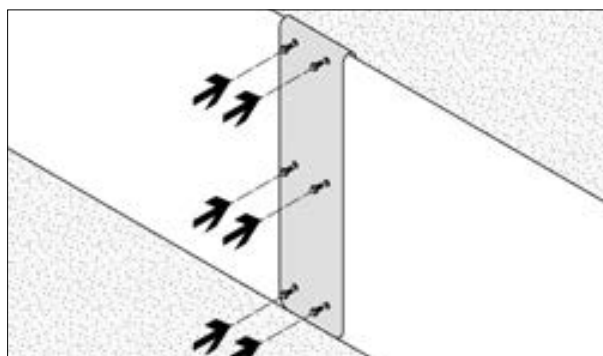
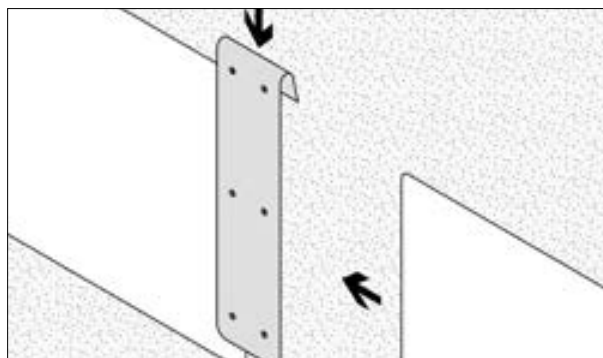

Straightcurve[®] Zero-Flex Raised Garden Bed Panel - 240mm

FHL240WS WEATHERING STEEL | FHL240GS GALVANISED STEEL

Product features

The details that make the difference

Full face visible instead of burying the edge.
Discreet join seams for a stylish finish



Option 1 (D): Anchor post sets for fast, strong staking

Option 2 (F): Universal bracing set as alternative hard surface bracing option



Angular twice folded top profile and return foot for Zero Flex performance

Round edged square tops for child and pet safety



Movable fixing spikes for easy obstacle avoidance





Precision engineered joint sets for fast, no weld connection method

EDGE STYLE



FINISHES

-  Galvanised Steel
-  Weathering Steel

For lasting, perfectly straight unmovable lines

Product specifications

TECHNICAL SPECIFICATIONS

Panel Lengths	400/600/800/1000/1200/2000 mm
Top edge thickness	46mm
Steel plate thickness	2mm
Weight per panel	3.5/5.0/6.6/8.2/9.7/15.8kg

BULK BUYING

Pack quantity	10
Bulk pack weight	35/50/66/80/97/158kg



JOIN SETS ARE REQUIRED

- A** Straight join set (panels in a line) *
- B** Closed corner set (standard 90°, right angle) *
- C** Reverse Corner set (270°, L-shapes) *

*All require Tek screws, select the required sets to suit configuration

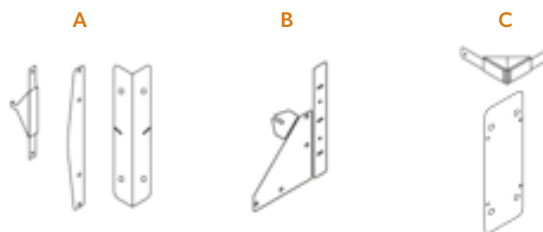

ADDITIONAL ACCESSORIES

REQUIRED

- D** Ground anchor set - 470mm, use one for every straight join/ one extra for 2000mm panel
- E** Fixing spikes, galvanised, 300mm long
 - 2 for 400/600/800mm panels
 - 3 for 1000/1200/2000mm panels

OPTIONAL

- F** Universal bracing set as ground anchor post alternative (turnbuckle/cable or chain/T-stake)

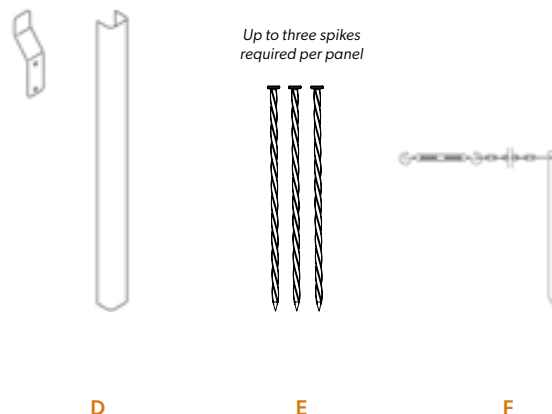

Choosing the right panels, join sets & accessories

In three easy steps

Step 1: Sketch out your raised garden bed shape including dimensions of all sides.

Step 2: On your sketch, mark out all panel sizes required to build your design. Note: Straightcurve® planter panels are available in 400mm, 600mm, 800mm, 1000mm, 1200mm and 2000mm long lengths to make up a 'nearest to' option.

Step 3: Jot down the number of panels of each length needed for your design. Do the same for joining accessories (circle each panel join and tally the number of straight joins, closed corners, and reverse corners required). The number of straight joins also counts for the number of ground anchor sets needed (see bracing advice).

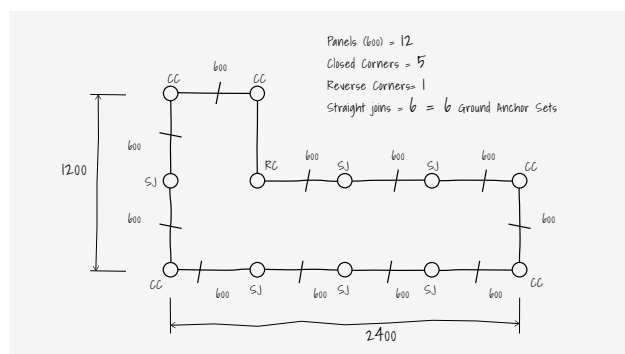
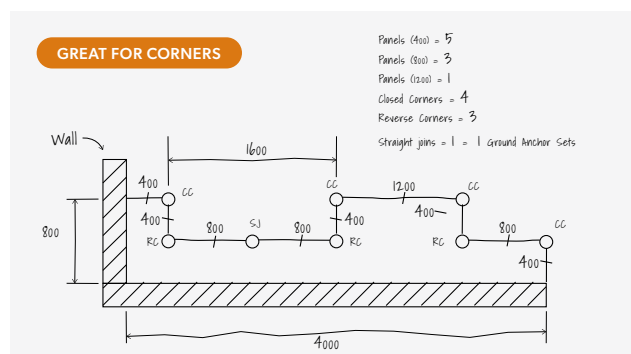
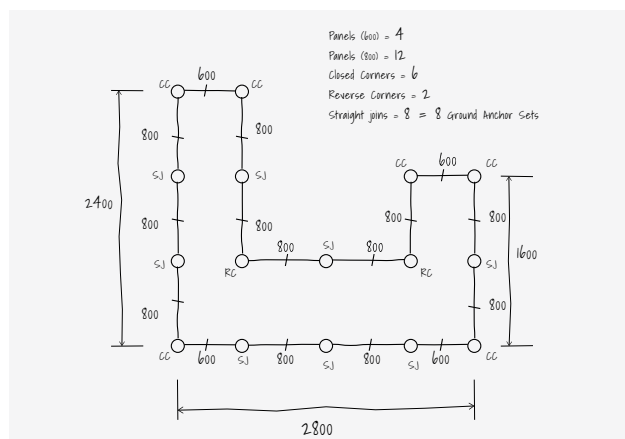
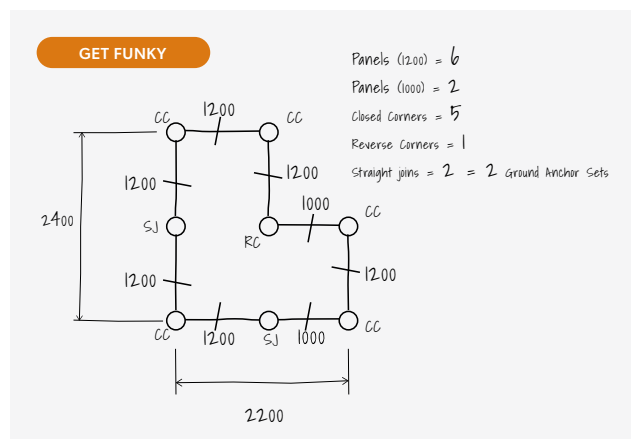
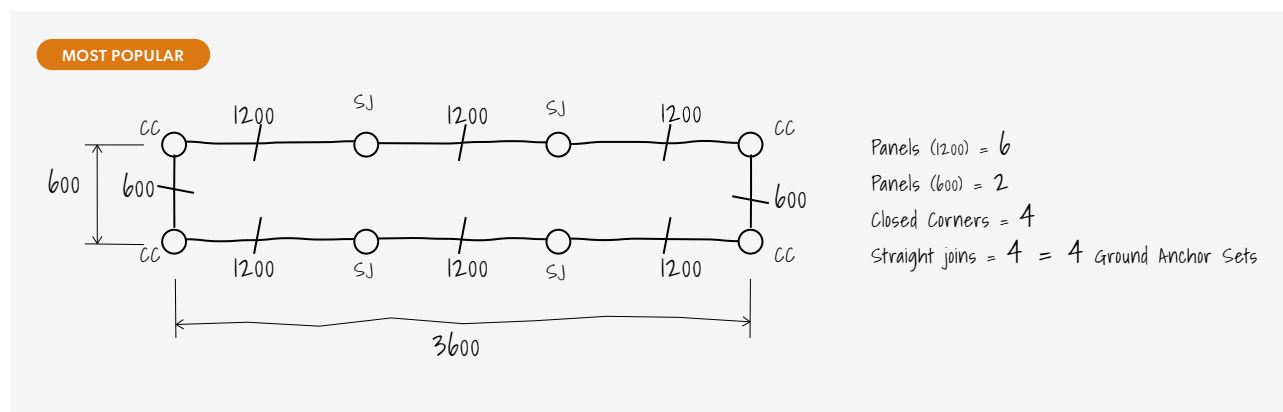

Note: the join sets bring the panels snug together, but manufacturing tolerances mean the total length once joined may be marginally longer (talking mm's) than expected, so be careful with tight spaces!

*see what panel sizes are locally available or if lead times apply for any panel sizes, prior to planning.

Zero-Flex Raised Garden Bed Panel - 240mm Installation Guide

Scan or click to watch install video



REQUIRED FIXINGS

- Closed corner set
6 x Tek Screws (12G x 16mm)
- Straight join set
10 x Tek Screws (12G x 16mm)
- Reverse corner set
6 x Tek Screws (12G x 16mm)
- Ground anchor set
2 x Tek Screws (12G x 16mm)

RECOMMENDED TOOLS

- Ground leveling tools
- Metal hammer
- Cordless drill and Tek screw bit
- Pliers

PREPARATIONS

The Zero-Flex Raised Garden Bed requires NO digging in as it is fixed at the feet to the ground surface. The ground should be level for the edge to sit flush on during installation. Any obstructions should be removed or re-routed. It can be installed on all level ground types including concrete surfaces (where packers are used to sit edge off ground to allow drainage).

DO...

- ✓ Check the line with a string line before fixing the base
- ✓ Use join set parts in the stepped order recommended
- ✓ Get the top join pieces to sit just right before screwing tight
- ✓ Use the Universal Bracing Set for bracing retaining steps
- ✓ Brace near to or at all straight joins
- ✓ If installing on a hard surface line the bed to prevent grit spill
- ✓ Set drill speed to high when drilling into ground anchor posts

DON'T...

- ✗ Set directly onto a hard surface without raising slightly with packers
- ✗ Forget to stake/brace any straight joins or ends
- ✗ Accelerate rust with acids or salts (but soapy water is ok!)
- ✗ Try and use pop rivets, requires Tek screws for strength
- ✗ Forget the safety gloves when working with steel!

MARKING OUT AND SECURING ASSEMBLED GARDEN BEDS

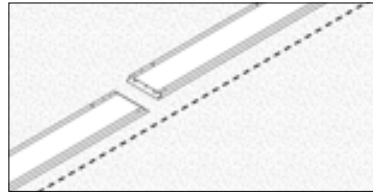

MARKING SHAPE - Mark edge line or use string line on flat ground and layout edge pieces nearby. All panels will now require joining by way of joining option A, B or C.

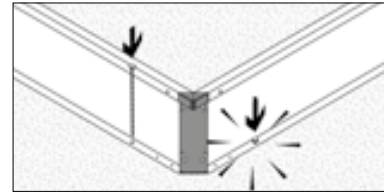

SECURING TO GROUND - Once ALL the panels are joined and in the exact finishing position use fixing spikes to secure base through holes in foot.

STAKING / BRACING FOR SUPPORT - Will be required and two methods are explained in following pages.

BACKFILL - Evenly to complete the project once staking/bracing is done.

(A) STRAIGHT JOIN

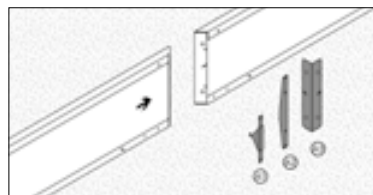

STEP 1 - For a straight join (two panels in a line) use the Straight Join Set (A). Separate the pieces in the set.

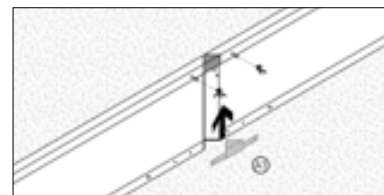

STEP 2 - Stand the first two panels together on a flat surface and insert top connector piece (A1), align guide holes and screw

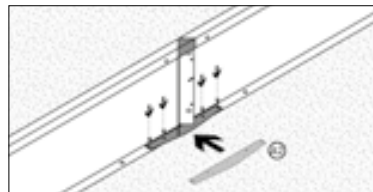

STEP 3 - Slide in foot joiner (A2), align guide holes and screw

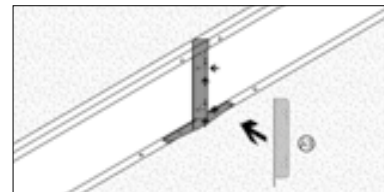

STEP 4 - Fit back rib (A3) flush to align guide holes and screw.



STEP 5 - Connect further panels to extend line of Raised Garden Bed panels.

(B) RIGHT ANGLE CORNER (90°)

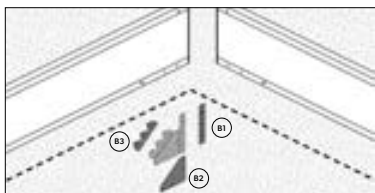

STEP 1 - When creating a standard right angle corner (90°) use the Corner Join Set (B). Break apart the pieces in the set.

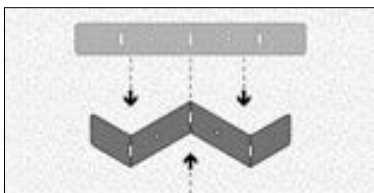

STEP 2 - Take strip piece (B1) and use pliers to shape into staircase pattern.

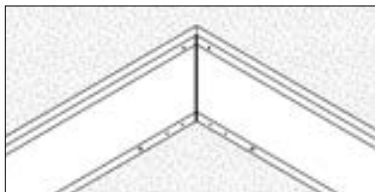

STEP 3 - Stand the two panels at right angles to each other and butt together.

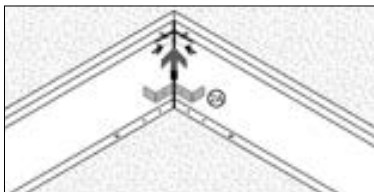

STEP 4 - To join - insert top connector 'staircase' piece (B1), align guide holes and screw.

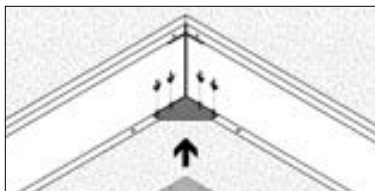

STEP 5 - Slide in foot joiner (B2), align guide holes and screw.

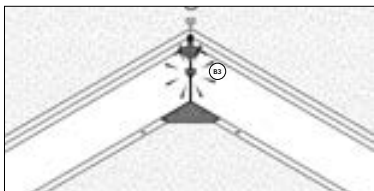

STEP 6 - Firmly grip and hammer arrow shaped wedge piece (B3) into angled slot at back to fully secure the join.

(C) REVERSE CORNER (L SHAPE BED)

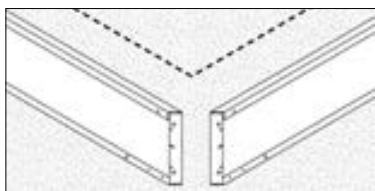

STEP 1 - For a reverse corner stand the two panels in the L shape formation and butt them together.

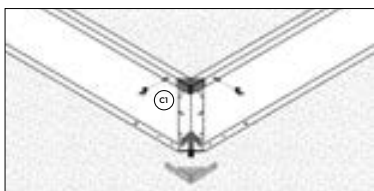

STEP 2 - From the reverse corner join set (C), insert (slide in) the top piece (C1) as shown and align guide holes and Tek screw in place.

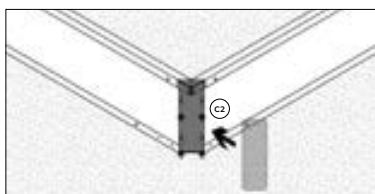

STEP 3 - Position the back fixing plate (C2) to align with the guide holes and Tek screw to secure

BRACING THE PANELS

ALL straight joins and garden bed ends will require bracing Either:

1. Use Grounding Anchor Set (A) - 470mm adjacent straight joins and at wall ends (also required in middle of 2000mm length panels). Fitting lip (B) is set behind the top lip of panel and then screwed to ground anchor post; OR
2. Use Universal Bracing Set to hook into top hole in join rib and anchor to the ground, adjusting tension with the turnbuckle. For the middle of the 2000mm panels there is no point of attachment, but bracing at that point is required. The turnbuckle can be secured there by drilling out an hook in hole in the back of the fold over lip.

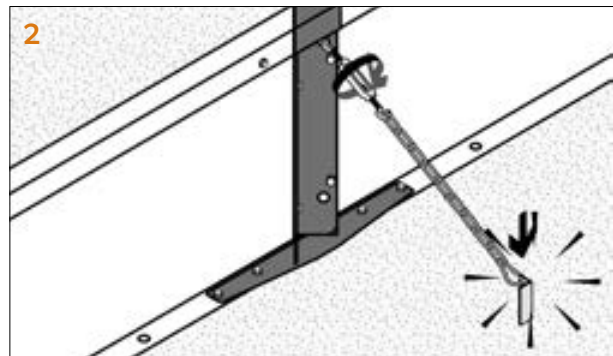
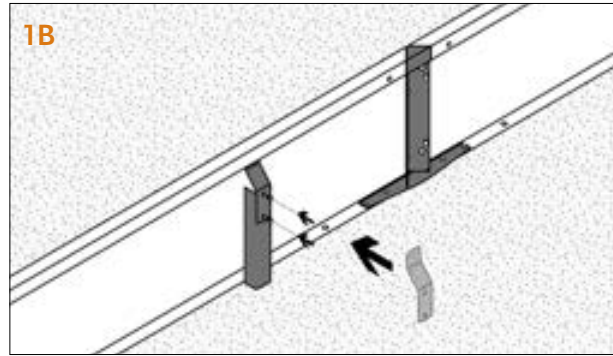
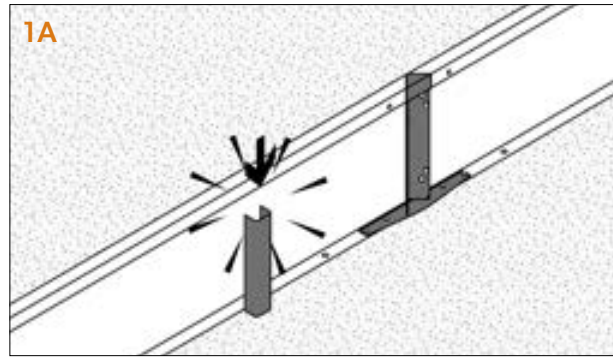

HARD SURFACE BRACING METHOD

The 470mm ground anchor posts cannot penetrate some hard and rocky ground. In these situations use the Universal Bracing Sets by fitting the turnbuckle with cable or chain to the straight joins through hook in holes and anchor back to the ground.

1. The stake that comes with the Universal Bracing Set is of a star picket style and will penetrate very hard surfaces, as do the fixing spikes that lock in the feet.
2. On concrete, a bolt down method can be used in place of the stake, anchoring the cable or chain with a DynaBolt™ (A). Bolt the foot holes in place with an 8mm DynaBolt™ (B), but first introduce packers to raise it slightly for drainage.

TIP : When using the Universal Bracing Sets, securing the anchor point to alternative structures such as walls or fences is also a workable solution.

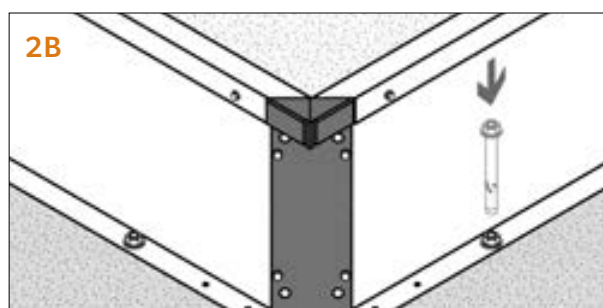
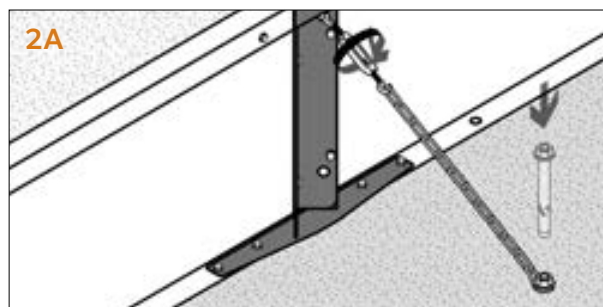
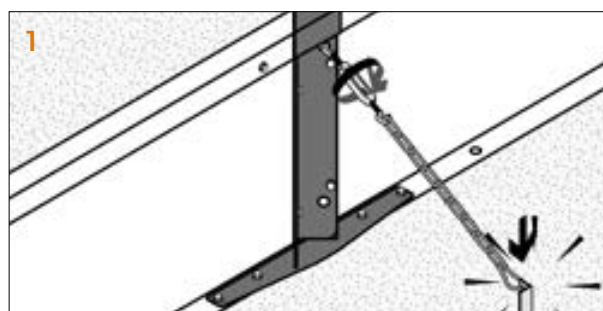

MAKING DIFFERENT HEIGHT RAISED GARDEN BEDS

The Zero-Flex raised garden beds look great in combination, with different heights placed together. They are not join compatible between heights, so the way to do this is to build them as separate raised garden beds and then butt them together or position them in proximity. A perfectly level base would be key to achieving this look.

CREATING STEP FACES WITH ZERO-FLEX

Making steps is easy with the 240mm Zero-Flex where the width of the step can be selected as a complete panel. This works when the ends are hidden and discreetly secured. One way to complete the step is by building a complete rectangle box and filling and stacking them as they are installed up the slope. Alternatively, create a front step face and return at the sides using a closed corner set and additional panel. Either way, be sure to use extra ground anchor sets behind the panel and concrete around them to ensure sufficient retaining strength.

SPECIAL CASE - USING A 2000MM PANEL

These panels are the longest available and will require a ground anchor set at the midpoint as well as where straight joins occur. If using the Universal Bracing Set a hole would need to be drilled into the back panel lip midway along the panel to allow attachment of the turnbuckle.

Technical Drawings

75mm

100mm

150mm

240mm

400mm

560mm

Planter boxes

STRAIGHTCURVE® FLEX RAISED GARDEN BED PANEL - 240MM

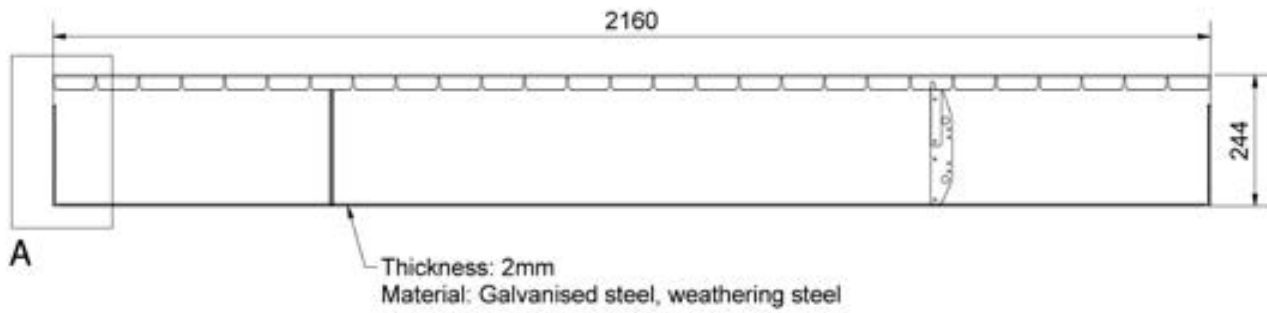

STRAIGHTCURVE® RIGID RAISED GARDEN BED PANEL - 240MM

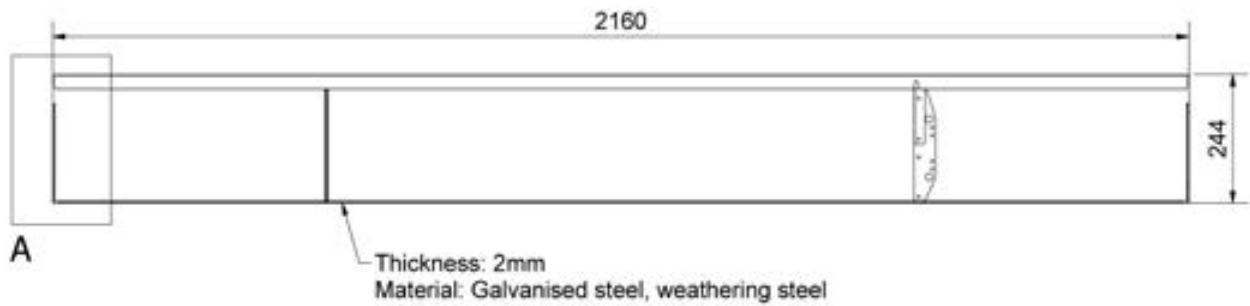

UNIVERSAL SPECIFICATIONS

SIDE PROFILE/JOIN FLANGE

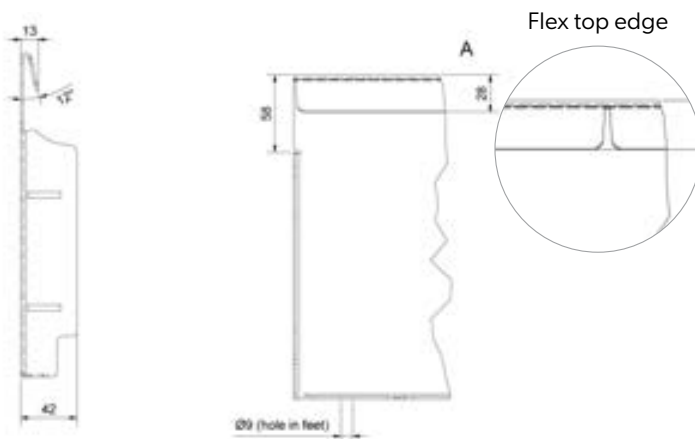



75mm

100mm

150mm

240mm

400mm

560mm

Planter boxes

STRAIGHTCURVE® ZERO-FLEX RAISED GARDEN BED PANEL - 240MM NEW PRODUCT

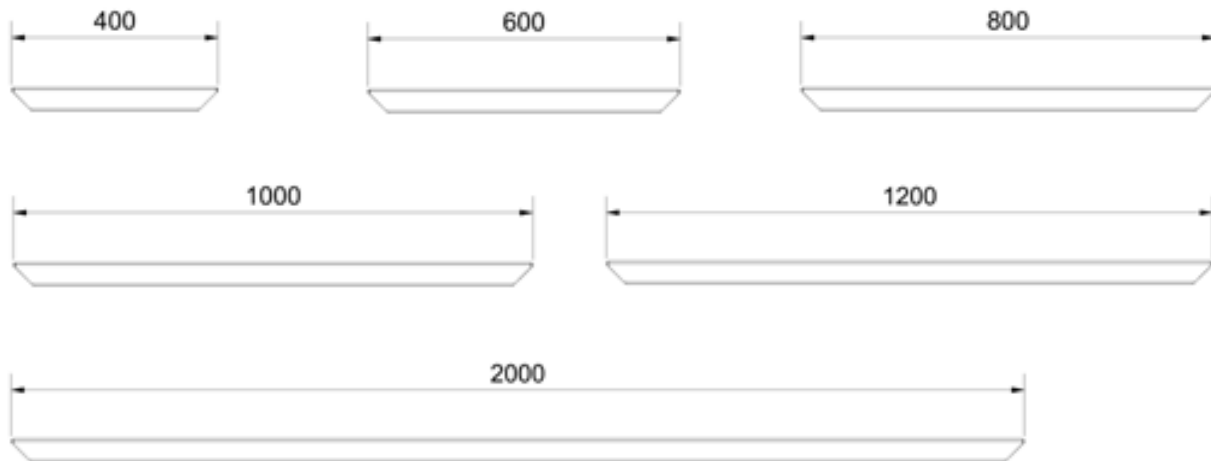

PANEL END/JOIN FLANGE

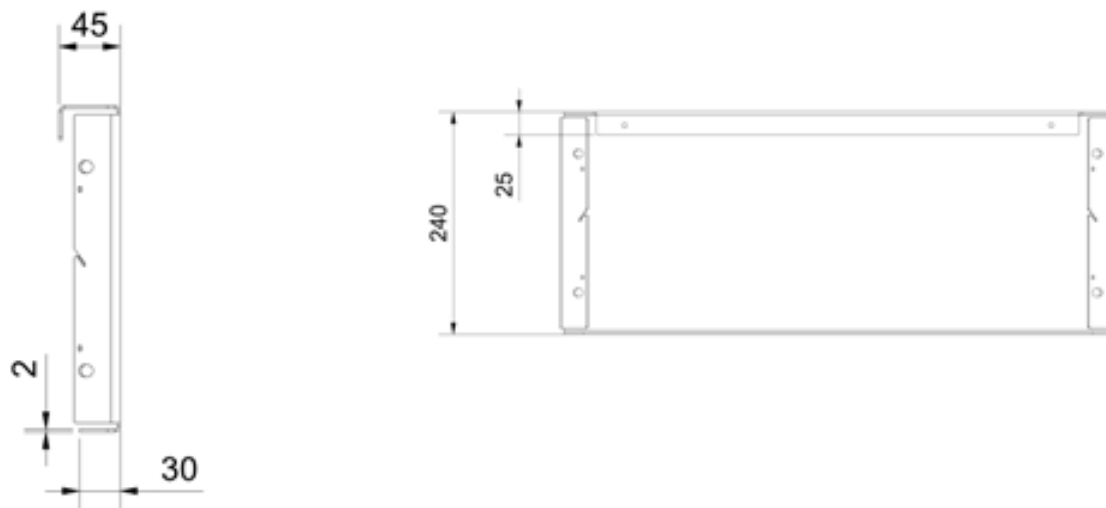

400mm Raised Garden Beds

For curved and straight Raised Garden Bed situations.

Do you know what Raised Garden Bed product is best for your project? Let's figure that out together here!

Use these edges as



RAISED GARDEN BEDS
Raised Garden Bed borders

OR



FEATURE RAISED GARDEN BEDS
Closed shape garden beds

OR



LOW RETAINING & TERRACED BEDS
Access on a sloping block

Perhaps it looks something like these?



Straightcurve® Flex Raised Garden Bed - 400mm



Straightcurve® Zero-Flex Raised Garden Bed - 400mm

How do you choose the 400mm Raised Garden Bed that's best for you?

We have solutions for curved and straight Raised Garden Bed situations. Use the below table to consider which is the best option from our range for your project. It's your call and we hope these recommendations makes it easier!

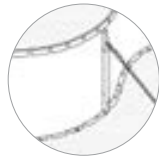
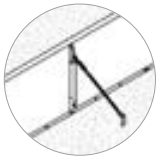
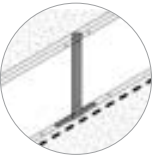
I'm looking for...	We recommend for this ...		
	 Flex - 400	 Rigid - 400	 Zero-Flex - 400
Something I can do myself	✓	✓	✓
A super high-quality raised garden bed that's stylish and strong	✓	✓	✓
Tree rings	✓	✗	✗
Something rigid that helps me to create a straight run	✗	✓	✓
A straight edge that will stay true and won't waver	✗	✗	✓
An edge ideal for linear designs with plenty of corners	✗	✗	✓
Something with a square shaped top edge making it appear boxy	✗	✗	✓

How about this!? It's also possible to combine styles, as our Flex Raised Garden Bed panels and Rigid Raised Garden Bed panels are join and profile compatible.

Product overview

ROUNDED TOPS AND SAFETY FEATURES

The smooth, rounded tops and edges assist safe handling. When installed, all joins/fixings are internal so that the exposed top and front present as a smooth top edge and continuous fascia.

SAFER AND CLEANER HANDLING

We recommend wearing gloves as the manufacturing process can leave residual oils/dust and our products can get hot when exposed to sunlight. Our products are shipped in bundles, when lifting bundles handlers should be mindful of their carrying capabilities. Single items are easy to carry for one person (see product weights).

ABOUT WEATHERING STEEL

The manufacturing process of weathering steel leaves the surface in a dark, almost black state. This dark 'finish' is an oxide layer that forms during the hot rolling process. The weathering process needs to break this layer down first before the desired protective patina layer can be established. You can expect some inconsistency in the patina formation because the thickness of the oxide layer varies; it'll appear spotty with some areas going orange and others still black.

The patina develops naturally with periods of wet and dry, and both phases are key for its steady formation. Do not wet continually without allowing time for thorough drying. A faster patina formation can be aided by cleaning the surface with soapy water to remove oil residue, but anything harsher is not advised as it can be detrimental to patina development and consequently, reduce product lifespan. Some rust solution products are safe to use as these 'build a surface patina' rather than just accelerating rusting.

WHAT IS A PATINA

Patina is not the same as rust. All rust is patina, but not all patina is rust. Patina is a chemical bond between various elements and usually oxygen. It can be found on most metals with the exception of 8 inert (noble) metals like gold or silver. 'Normal' rust is iron-oxide, the patina referred to above is mostly a bond between copper, phosphorus, chromium, nickel, iron and oxygen. You may wonder, how does water feature in it? Water acts as an electrolyte, but that's a different story. In the end, the patina formed on

weathering steel is a dense layer that doesn't flake or allow oxygen through. Therefore, once formed, the oxidation process slows down dramatically.

WILL THE STEEL STAIN MY PAVERS OR DECK?

This can occur in the early stages of rusting but can be avoided with care, such as by protecting nearby surfaces while the patina establishes. The worst cases of this you will see involves mild steel because the rusting carries on unabated. With weathering steel this should only happen when first developing a patina or if rushed artificially (sped up with acids/salts) to achieve faster colour change. What you can do as an excellent strategy is pre-rust the edging before installing to have a stable early phase patina there already. This doesn't need to take long if you procure a rust solution recommended for steady patina formation.

LONGEVITY

Our products are of the highest quality ensuring longevity in the given environment. For further information please refer to the "Longevity Guide" and "Product Care Guide" on our website.

PAINTING, SEALING AND POWDERCOATING

Our galvanised products are suited to painting, but the surface should be thoroughly prepared (using acetone wash), and sealed with a metal primer (etch primer is very good) to maximise topcoat adhesion.

Powdercoating is a much more durable/hardy choice, and can be requested for large projects with lead times/costings supplied. It is worth noting that not all powdercoating performs the same, we use and recommend Interpon powder from AkzoNobel for assured quality and maximum endurance and suggest you request the same. It's also worth asking first to see a sample from your chosen powdercoater specialist. Note that, as for painting, galvanised products should be used whenever powdercoating.

75mm

100mm

150mm

240mm

400mm

560mm

Planter boxes

Another question we get relates to freezing the colour (or patina development) at a certain stage. That's possible using a transparent sealant suitable for steel. Keep in mind that the colour will change when applying a sealant, it'll get a 'wet' look. Be sure to test this in a small inconspicuous area first before fully committing. This will require reapplication once a year.

WHEN IS CONCRETING AROUND THE ANCHORS AND FIXING SPIKES NECESSARY?

For an install on sandy/soft/shifting ground conditions it's important to set the foot-stabilising galvanised fixing spikes and ground anchor stakes or posts into some concrete for extra hold. If you're not sure about the ground condition, the firmness of the subsurface ground when the spikes are hammered in is a good indicator as to whether concreting is needed; they need to gain purchase and feel rigid. The 400mm Raised Garden Beds experience a considerable outward force acting upon them so if in doubt, use some concrete.

HOW TO POSITION THE EDGE

These Raised Garden Beds have a front facing side with discreet joint seams, while the back side retains the actual garden fill, meaning all joints and bracing systems are hidden.

Be mindful also that a garden bed can settle at lower than the install levels and may require topping up later to maintain the look initially achieved with your Raised Garden Bed. This top up practice can also increase lifespan, as the protective patina formation may be inconsistent in previously buried portions.

HOW DEEP DO I BURY THE EDGE?

For all these products there is no need to bury the edge. Traditionally, it has been necessary to bury up to one third of the panel when using steel for raised garden beds, but the lockdown foot design means that is not required and you get to see the full face of the panel. You effectively get the same result as the old ways, with a third less steel!

That said, sometimes these products are used as a partly buried raised garden bed edge. This is particularly effective in sloping situations where the ground meeting the edge is not level, so the degree of panel showing changes along the run of the raised garden bed.

WHY DO WE SUPPLY AND RECOMMEND TEK SCREWS?

When fixing the ground anchor sets to the edge use Tek screws for their self-tapping (self-drilling) abilities. This is an easy, fast and strong method. The long lasting, grey Dacromet Tek screws are best for all the buried screw locations of these products.

ADVANTAGES

- ✓ Continuous smooth top square or rounded edges
- ✓ Corners available or easily made in situ with Flex and Rigid lines
- ✓ Up to 3x faster installation
- ✓ No welding required
- ✓ No burying the edge required
- ✓ No Experience/training needed
- ✓ Designed for ease of use

Straightcurve® Flex Raised Garden Bed Panel - 400mm

FL400WS WEATHERING STEEL | FL400GS GALVANISED STEEL

Product features

The details that make the difference

Wedge and slider join system for a faster, stronger no weld method



Full face visible instead of burying the edge. Discreet join seams for a stylish finish

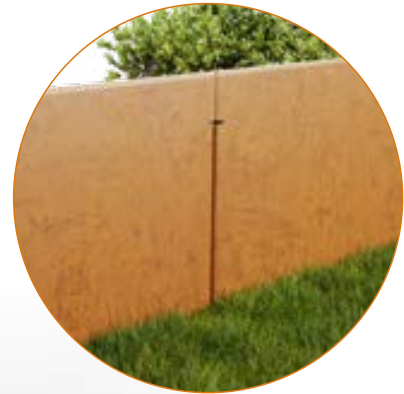

Universal bracing set with turnbuckle for fast, easier bracing

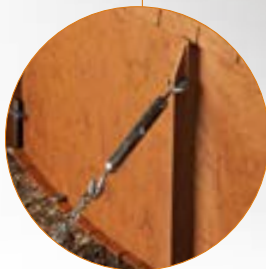

Movable fixing spikes for easy obstacle avoidance



Notched top and feet for smooth, even curves



8mm rounded tops for child and pet safety

EDGE STYLE



For smoothly curving Raised Garden Beds that look great and hold position once shaped & installed.

FINISHES

- Galvanised Steel
- Weathering Steel

Product specifications

TECHNICAL SPECIFICATIONS

Length	2160mm
Top edge thickness	8mm
Steel plate thickness	2mm
Weight per length	16kg

BULK BUYING

Pack quantity	20
Bulk pack weight inc. pallet	349kg

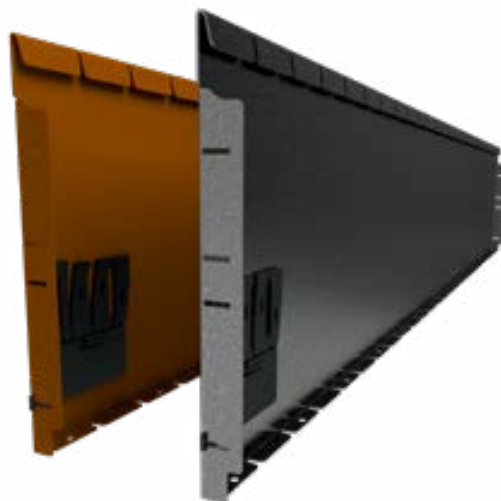

SOLD AS SET INCLUDING

- Joining set includes 1 X join bracket (A), 3 x slider (B), 3 x wedge (C)
- 5 x Fixing spikes, galvanised, 300mm long
- 2 x bracing ribs (attached to panel/movable)

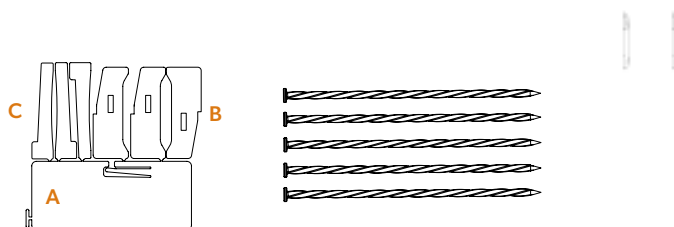

ADDITIONAL ACCESSORIES

REQUIRED

- D Universal bracing set as ground anchor post alternative (turnbuckle/cable or chain/T-stake)

OPTIONAL

- E Corner piece (90° right angle / arm lengths: 255mm)
- F Reverse corner piece (270° L-shape / arm lengths: 255mm)
- G Ground anchor set - 1100mm (Tek screws required)
- H Join part for offcuts (Tek screws required)

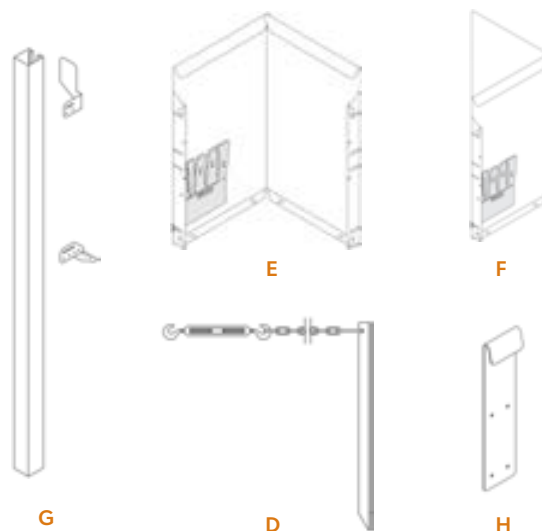

Flex Raised Garden Bed Panel - 400mm Installation Guide

Scan or click to watch install video



REQUIRED FIXINGS

- Ground anchor set
6 x Tek Screws (12G x 16mm)
- Join part for offcuts
8 x Tek Screws (12G x 16mm/ zinc colour for WS)

RECOMMENDED TOOLS

- Ground leveling tools
- Metal hammer
- Rubber mallet
- Cordless drill and Tek screw bit (for accessories **G** and **H**)
- Angle grinder (required if modifying lengths or fashioning corners/ends)

PREPARATIONS

The Flex Raised Garden Bed requires NO digging in as its feet are secured to the ground surface. The base should be smoothed/ leveled for the edge to sit flush on the ground during installation. Any obstructions should be removed or re-routed. It can be installed on all level ground types including concrete surfaces (where packers are used to sit edge off ground to allow drainage). It is useful to have some cardboard or board to place under joins when connecting with the panel face down on flat ground. Grass and debris likes to get caught in the tight seam!

DO...

- ✓ Join all lengths in place and perfect the line before finally fixing in position.
- ✓ If using a pre-made corner start from there and work back.
- ✓ Score an intermittent line rather than one deep score line if making corners.
- ✓ Follow the instructions carefully and do it with a friend If making a two panel ring.
- ✓ For circular beds backfill evenly for equal outward pressure.

DON'T...

- ✗ Use for straight lines, instead use Rigid Or Zero-Flex options.
- ✗ Forcibly bend. Take care and gently flex the edge to shape.
- ✗ Forget to stake or brace your edge once joined unless making circular beds (less than 3m diameter).
- ✗ Accelerate rust with acids or salts (but soapy water is ok!)

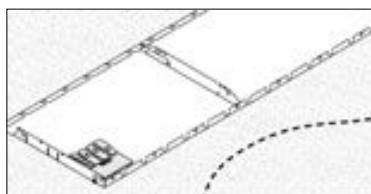

STEP 1 - Mark edge line on ground and layout edge pieces nearby.

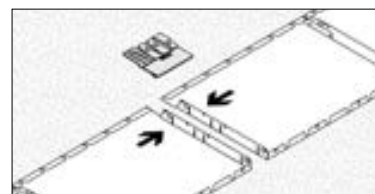

STEP 2 - Place first two edges front face down on the ground with ends touching and with join slots aligned.

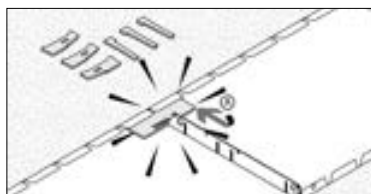

STEP 3 - Join using the joining set, break the pieces apart first by hand and insert join bracket (**A**) securely under the top lip (centred). Press it against back of panels (use a metal hammer to firmly lock in).

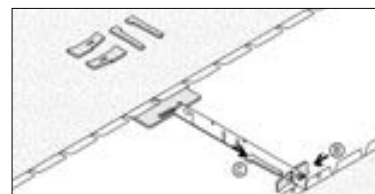

STEP 4 - Next, insert a slider (**B**) through adjacent bottom slots with its 'feet' against the edge. Knock it through fully so wedge (**C**) can insert and lock in the slider.

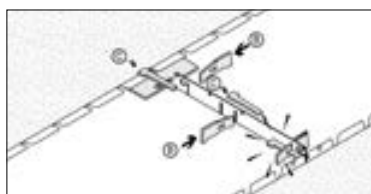

STEP 5 - Hammer the wedge in firmly. Repeat step 4 for middle and top slot using the remaining wedge and slider sets.

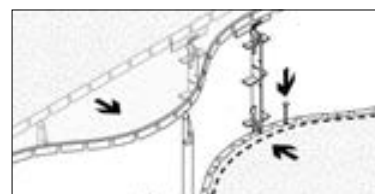

STEP 6 - Set these two edges upright and flex to position where desired, use fixing spikes as temporary placeholders.

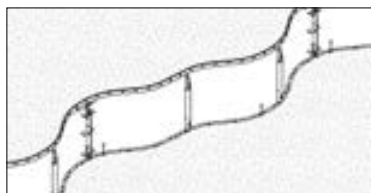

STEP 7 - Introduce and join further lengths (or joined pairs of lengths), butting them against the now standing edge, connecting them as you go.

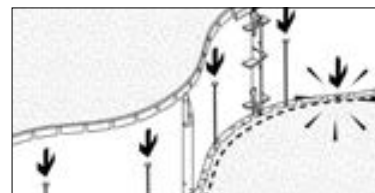

STEP 8 - Check the line, then hammer all fixing spikes (5 per length) through foot tab holes

CHOOSE YOUR BRACING METHOD

UNIVERSAL BRACING (TURNBUCKLE/CABLE OR CHAIN/T-STAKE)

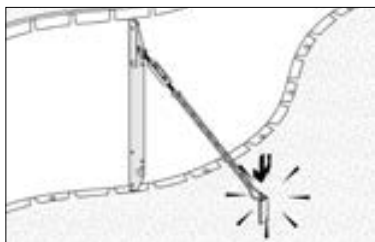

STEP 9A.1 - Using the universal bracing set, hammer in the anchoring stake and connect to bracing rib with cable or chain and turnbuckle taut.

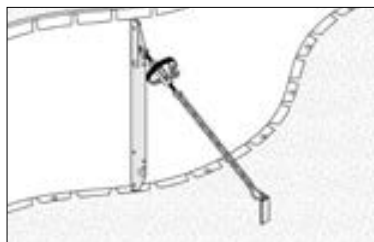

STEP 9A.2 - The turnbuckle is then used for fine vertical adjustment.

ANCHORING SET

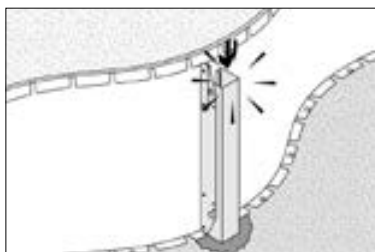

STEP 9B.1 - To stake, hammer to ground anchor post in tightly adjacent a bracing rib and close against the bottom foot.

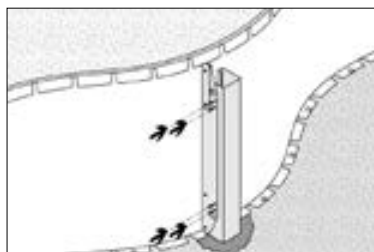

STEP 9B.2 - Screw the ground anchor post 1100 to the bracing rib with tek screws through guide holes.

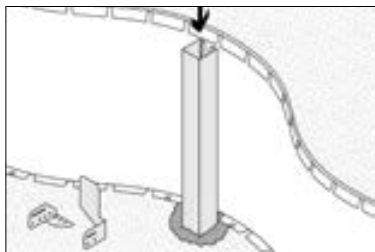

STEP 9C.1 - Alternatively brace with ground anchoring set-1100mm. These posts are installed flush against back of edge.

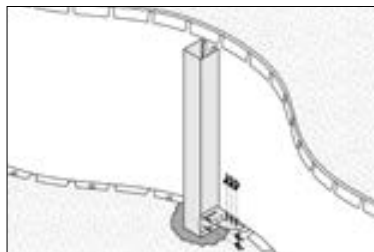

STEP 9C.2 - Once posts in position, screw the fitting set foot piece through guide holes to join the post and edge at the foot.

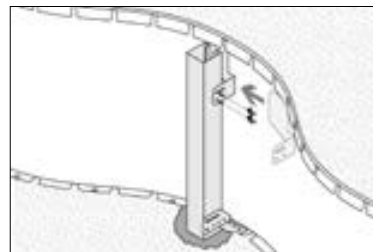

STEP 9C.3 - Fitting the top piece allows adjustment of the vertical, check carefully before final screwing to post.

CONTINUE TO FINISH

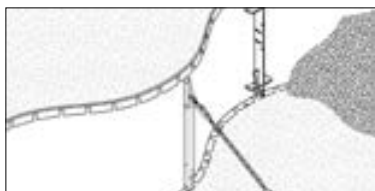

STEP 10 - Back fill your Raised Garden Bed to finish.

Creating corners

PRE-MADE CORNERS

Pre-made corners with 255mm long arms are available for purchase and include the standard joining set. There is a standard 90 degree right angle corner and a reverse corner for turnbacks such as when making an L-shape. It's difficult, but the angle of these pre-made corners can be adjusted by applying considerable force using ratchet straps or other means.

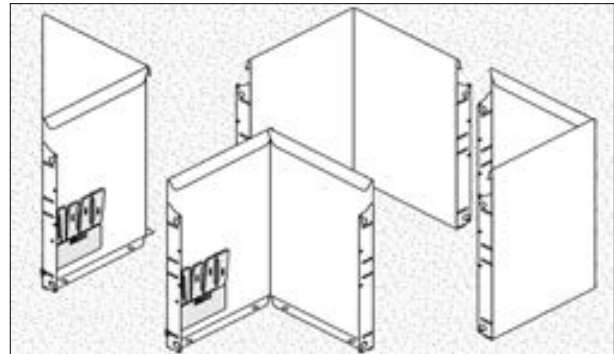

MAKING YOUR OWN CORNERS

To make a corner yourself you will need to use an angle grinder. Be sure to operate safely with all suitable gear.

1. Mark a vertical line down the back of the edge directly beneath a top edge notch space where the corner fold is needed. With the angle grinder score the line in three places sufficiently to create a fold line.
2. Also cut a gap in the top lip and remove a bottom foot tab on one side of the fold line to allow room for bending in.
3. Bend strongly by hand; using a block of wood close to the fold to form the bend against helps.

For reverse corners (~270°) a fold line will need to be cut in as above. Also raise the height of the notch groove to the top of the lip neatly to aid the bend. No other cuts are required.

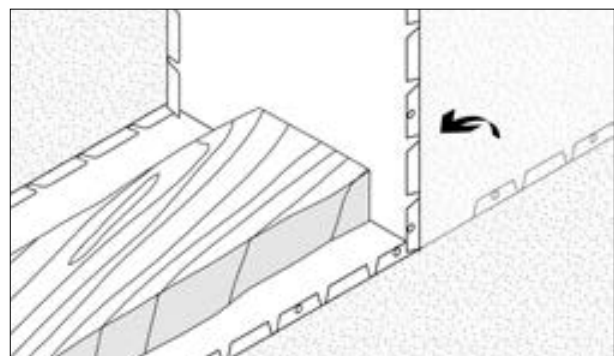
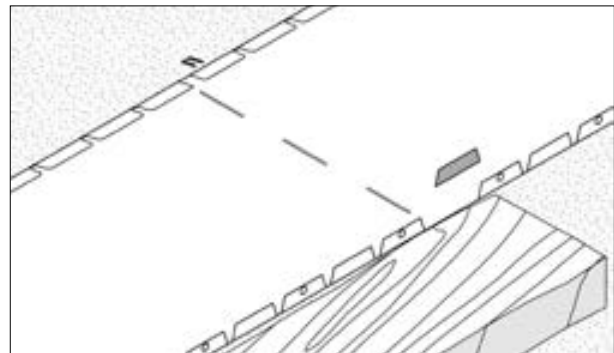

Creating circles

CIRCLES & CURVE CAPABILITIES

Connecting edge panels makes standard ring sizes. Design for complete edge lengths of 2 or more to give the desired diameter. Here's our standard sizes.

Standard Circle diameters

No. of panels:	2	3	4	5
Diameter:	1.37m	2.06m	2.75m	3.44m

In terms of curve capabilities, the 400mm Flex Raised Garden Bed Panel has a minimum radius achievable of around 700mm. It is designed to allow this degree of flex and no more. This is also why you cannot make a ring with one panel, the two panel ring is the smallest possible. If the Raised Garden Bed face makes a concave curve the back of the join flanges can gap slightly. To counter this, there are some pilot holes at the back edge of the join flange. Screw through these with Tek screws before creating the concave curve.

HOW TO MAKE A TIGHT CIRCLE (D:1370MM) WITH TWO EDGE PANELS.

Require 5m ratchet strap and sturdy rectangular board (recommend 600-1200mm wide X edge height).

This construction is best done with two people.

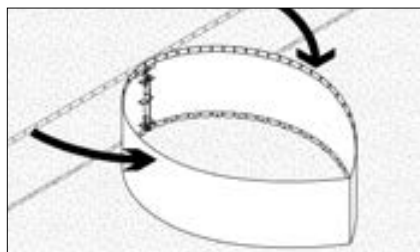

STEP 1 - Connect two panels with joining set, then pull ends in to meet in teardrop shape.

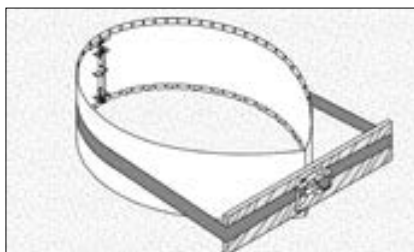

STEP 2 - Place ratchet strap around midriff and over the board, with the board positioned to pull in open end.

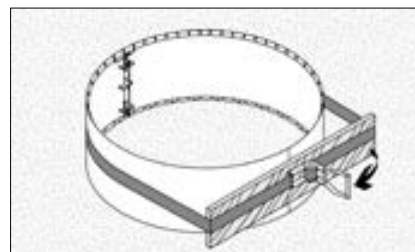

STEP 3 - Ratchet in until ends are flush, and fully align join flanges with gradual ratcheting.

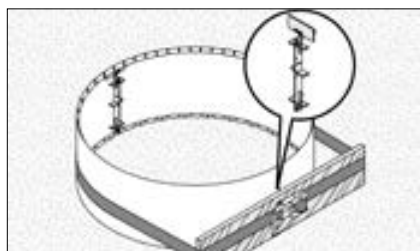

STEP 4 - When the edge end join flanges align perfectly, use joining set to lock together.

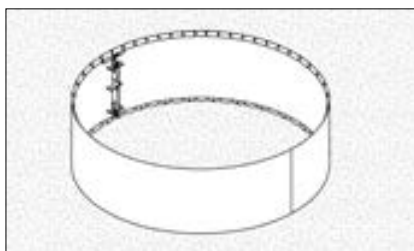

STEP 5 - Release ratchet and unstrap, it will be slightly oval in shape.

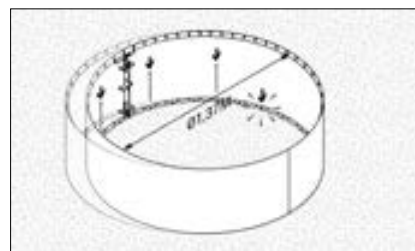

STEP 6 - Correct by hand to desired ring shape, measuring diameter (1.37m) and pin the feet to hold as you go. Use a rubber mallet to finesse shape.

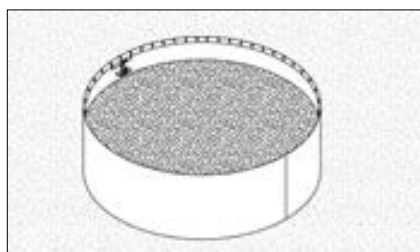

STEP 7 - That done, fill evenly, there is no need for bracing this self supporting circle.

Note: For three or more panels, two people can simply pull into shape and connect, without the need for ratchet approach

Bracing methods

BRACING ON VARIOUS HARD SURFACES

The Universal Bracing Sets are best suited for these conditions. Simply fit the turnbuckle with cable or chain to the pre-fitted bracing ribs and anchor back to the ground. Alternatively, the 1100mm ground anchor sets can be used on hard surfaces that allow a post hole.

1. The stake that comes with the Universal Bracing Set is of a star picket style and will penetrate very hard surfaces, as do the fixing spikes that lock in the feet.
2. On concrete, a bolt down method can be used in place of the stake, anchoring the cable or chain with a DynaBolt™. Bolt the foot holes in place with an 8mm DynaBolt™, but first introduce packers to raise it slightly for drainage.

TIP: When using the Universal Bracing Sets, securing the anchor point to alternative structures such as walls or fences is also a workable solution.

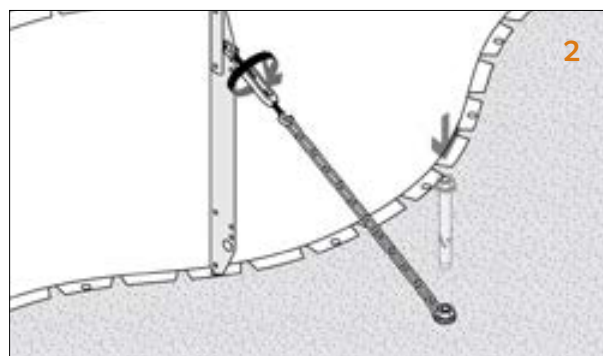
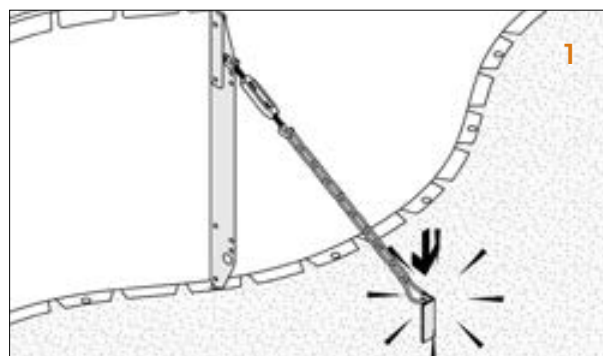

HOW TO MOVE A BRACING RIB

It's easy to move the bracing rib if it is located above an obstacle preventing staking there or where access to the rib will be difficult. Simply loosen and remove the bracing rib by knocking it sideways near the top with a hammer. It can then be refitted in a new place, inserting the base nub into a bottom foot tab hole first, and then tapping the upper part of the bracing rib with a hammer firmly to return it to a vertical position tight behind the top lip.

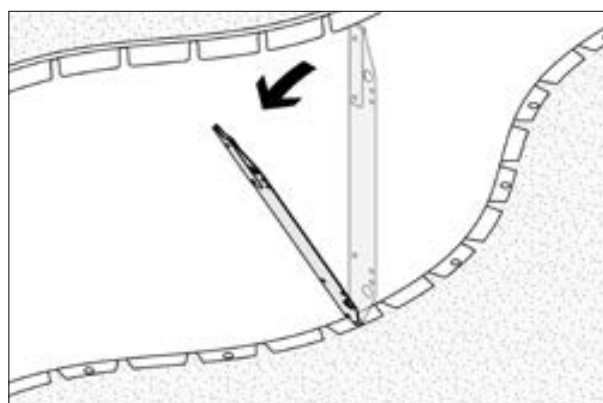

CREATING CONNECTION TABS OF YOUR OWN

To fix one end to a wall or other solid feature you can fix the folded back flange on the end of the panel to that surface. Simply bolt or screw as appropriate to fix it strongly.

If the edge panel is too long to do that, you can both shorten and create a join tab at the same time with your angle grinder. To do so measure carefully first, then remove the extra top lip portion and create the fold back piece by the score and bend method as shown. The tab can then be screwed internally to the surface it meets, which is sometimes another piece of Straightcurve®!

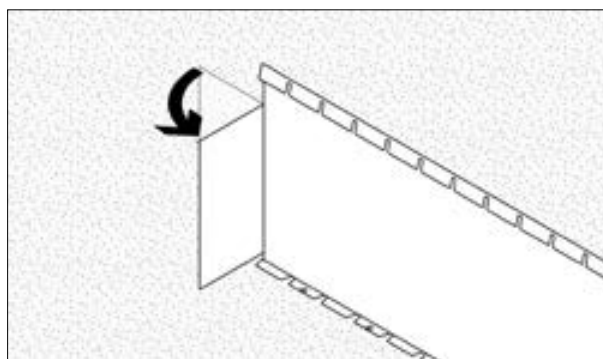
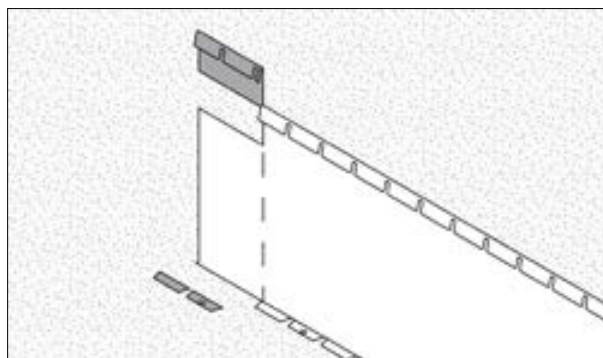

COMPATIBILITY AND WORKING ON SLOPES

1. The 400mm Flex Raised Garden Bed Panel is compatible with the 400mm Rigid Raised Garden Bed Panels. This allows them to work in combination.
2. In fact, join slots align across all Flex or Rigid panels (240/400/560mm) so that a continuous top edge occurs if different heights are joined together. This across height compatibility can be used to advantage with Raised Garden Beds on a slope. On the lower part of the slope the Raised Garden Bed run may need taller panels with a greater edge face visible due to the slope falling away, with panels of lesser height required further up the bank. It takes some careful planning, but can look very effective, adding volume and height to a bed while reducing the amount of steel used in the project overall.

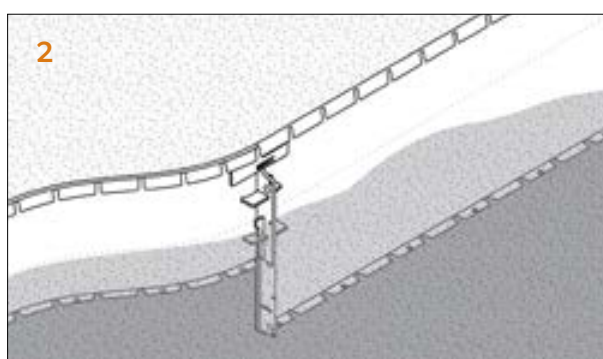
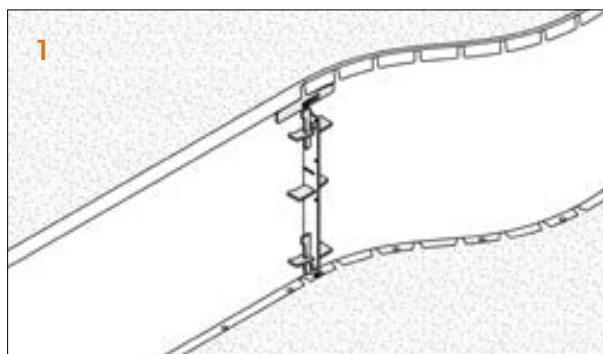

HOW TO USE A PANEL OFFCUT

When a length is shortened with an angle grinder it loses the join flange. To solve that problem we have a Join Part For Offcuts. This is simply screwed to the cutaway end (through guide holes in join part) and overlays the length it is joining. Further screwing sees both panels neatly connected.

This overlay Join Part does mean screws are visible on the face of the Raised Garden Bed, but it is helpful with perimeters that require a part length to meet or when making regular shaped beds where the side length is predetermined. It also means no offcuts are wasted!

Some tips here are to either place the join part in the least conspicuous spot and use Zinc Screws which blend in as they rust over (for Weathering Steel), or make a feature of it by adding more Join Parts to create a pattern. With that approach, you may even choose to substitute polished bolt heads in place of the discreet screws.

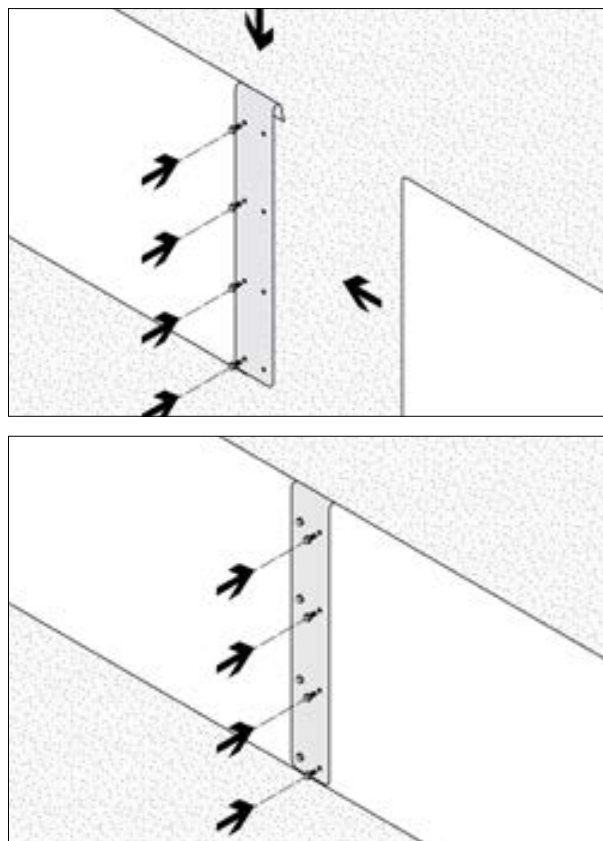

75mm

100mm

150mm

240mm

400mm

560mm

Planter boxes

Straightcurve® Rigid Raised Garden Bed Panel - 400mm

RL400WS WEATHERING STEEL | RL400GS GALVANISED STEEL

Product features

The details that make the difference

Wedge and slider join system for a faster, stronger no weld method



Full face visible instead of burying the edge. Discreet join seams for a stylish finish

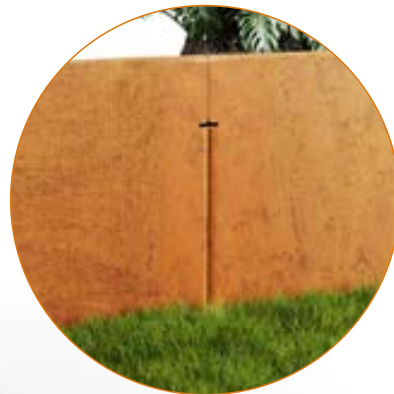

Universal bracing set with turnbuckle for fast, easier bracing



Movable fixing spikes for easy obstacle avoidance





Continuous Fold Top and Foot for rigid straight lines

8mm rounded tops for child and pet safety

EDGE STYLE



FINISHES

-  Galvanised Steel
-  Weathering Steel

For Raised Garden Beds with straight edges

Product specifications

TECHNICAL SPECIFICATIONS

Length	2160mm
Top edge thickness	8mm
Steel plate thickness	2mm
Weight per length	16kg

BULK BUYING

Pack quantity	20
Bulk pack weight inc. pallet	349kg



SOLD AS SET INCLUDING

- Joining set includes 1 X join bracket (A), 3 x slider (B), 3 x wedge (C)
- 5 x Fixing spikes, galvanised, 300mm long
- 2 x bracing ribs (attached to panel/movable)

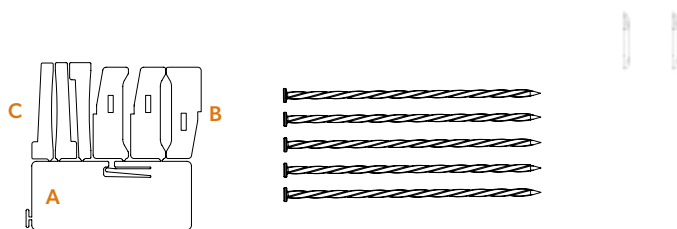

ADDITIONAL ACCESSORIES

REQUIRED

- D** Universal bracing set as ground anchor post alternative (turnbuckle/cable or chain/T-stake)

OPTIONAL

- E** Corner piece (90° right angle / arm lengths: 255mm)
- F** Reverse corner piece (270° L-shape / arm lengths: 255mm)
- G** Ground anchor set - 1100mm (Tek screws required)
- H** Join Part for Offcuts (Tek screws required)

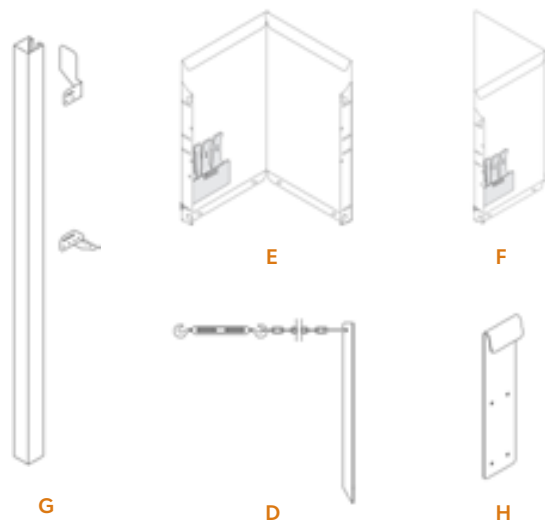

Rigid Raised Garden Bed Panel - 400mm Installation Guide

Scan or click to watch install video



REQUIRED FIXINGS

- Ground anchor set
6 x Tek Screws (12G x 16mm)
- Join part for offcuts
8 x Tek Screws (12G x 16mm/ zinc colour for WS)

RECOMMENDED TOOLS

- Ground leveling tools
- Metal hammer
- Rubber mallet
- Cordless drill and Tek screw bit (for accessories **G** and **H**)
- Angle grinder (required if modifying lengths or fashioning corners/ends)

PREPARATIONS

The Rigid Raised Garden Bed requires NO digging in as its feet are secured to the ground surface. The base should be smoothed/ leveled for the edge to sit flush on the ground during installation. Any obstructions should be removed or re-routed. It can be installed on all level ground types including concrete surfaces (where packers are used to sit edge off ground to allow drainage). It is useful to have some cardboard or board to place under joins when connecting with the panel face down on flat ground. Grass and debris likes to get caught in the tight seam!

DO...

- ✓ Check the line with a string line as you add more panels.
- ✓ If using a pre-made corner start from there and work back.
- ✓ Score an intermittent line rather than one deep score line if making corners

DON'T...

- ✗ Use for curved line designs, instead use Flex Raised Garden Bed
- ✗ Forcibly bend if aiming for a mild curve of a radius exceeding 26m
- ✗ Forget to stake or brace your edge once joined
- ✗ Accelerate rust with acids or salts (but soapy water is ok!)

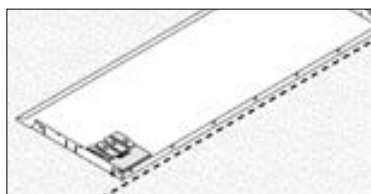

STEP 1 - Mark edge line on ground and layout edge pieces nearby.

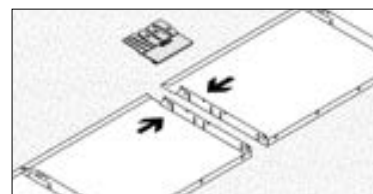

STEP 2 - Place first two edges front face down on the ground with ends touching and aligned.

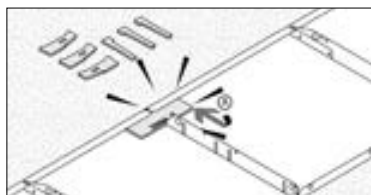

STEP 3 - Join using the joining set, break the pieces apart first by hand and insert join bracket (**A**) securely under the top lip (centred). Press it against back of panels (use a metal hammer to firmly lock in)

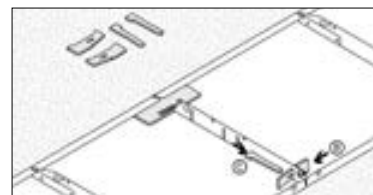

STEP 4 - Next, insert a slider (**B**) through adjacent bottom slots with its 'feet' against the edge. Knock it through fully so wedge (**C**) can insert and lock in the slider.

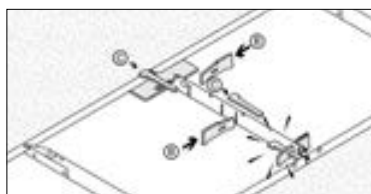

STEP 5 - Hammer the wedge in firmly. Repeat step 4 for middle and top slot using the remaining wedge and slider sets

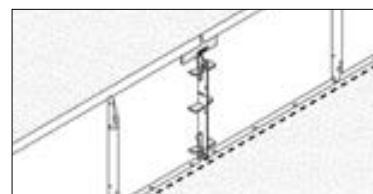

STEP 6 - Set these two edges upright and position where desired

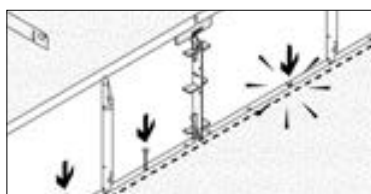

STEP 7 - Check the line, then hammer all fixing spikes (5 per length) through foot tab holes

75mm

100mm

150mm

240mm

400mm

560mm

Planter boxes

CHOOSE YOUR BRACING METHOD

UNIVERSAL BRACING (TURNBUCKLE/CABLE OR CHAIN/T-STAKE)

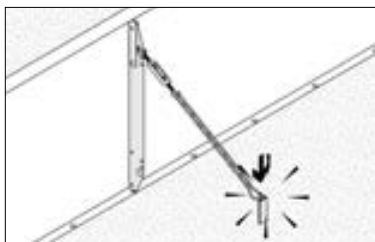

STEP 8A.1 - Using the universal bracing set, hammer in the anchoring stake and connect to bracing rib with cable or chain and turnbuckle taut.

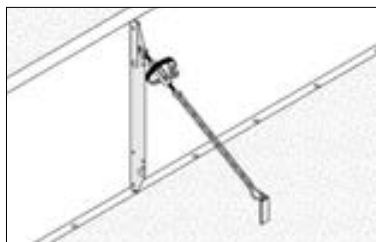

STEP 8A.2 - The turnbuckle is then used for fine vertical adjustment.

ANCHORING SET

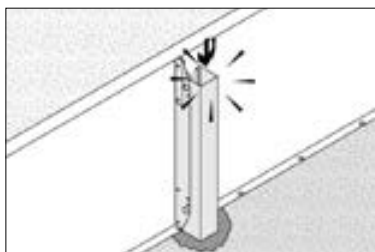

STEP 8B.1 - To stake, hammer to ground anchor post in tightly adjacent a bracing rib and close against the bottom foot.

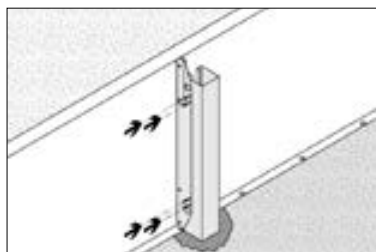

STEP 8B.2 - Screw the ground anchor post 1100 to the bracing rib with tek screws through guide holes.

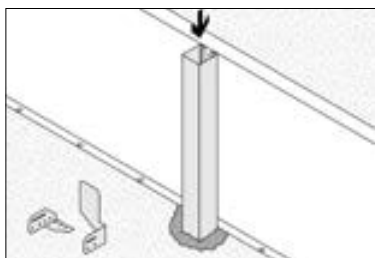

STEP 8C.1 - Alternatively brace with ground anchoring set-1100mm. These posts are installed flush against back of edge

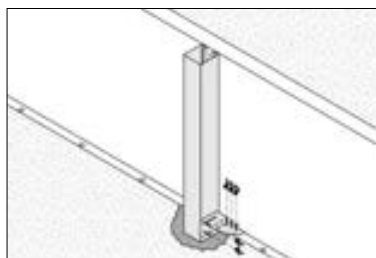

STEP 8C.2 - Once posts in position, screw the fitting set foot piece through guide holes to join the post and edge at the foot

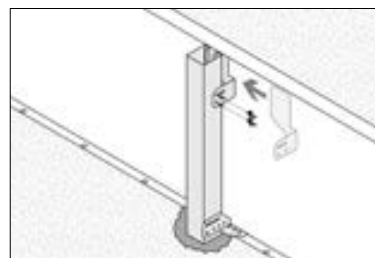

STEP 8C.3 - Fitting the top piece allows adjustment of the vertical, check carefully before final screwing to post

CONTINUE TO FINISH

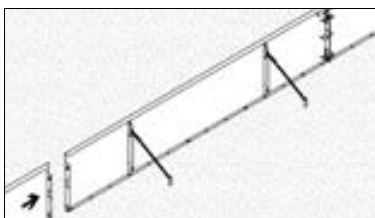

STEP 9 - Introduce further lengths (or joined pairs of lengths), butting them against the now standing edge and connecting them and bracing them as you go.

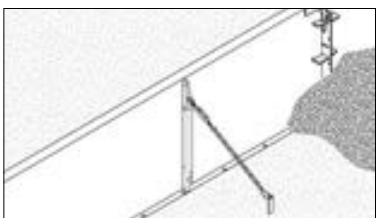

STEP 10 - Back fill your Raised Garden Bed to finish.

Creating corners

PRE-MADE CORNERS

Pre-made corners with 255mm long arms are available for purchase and include the standard joining set. There is a standard 90 degree right angle corner and a reverse corner for turnbacks such as when making an L-shape. It's difficult, but the angle of these pre-made corners can be adjusted by applying considerable force using ratchet straps or other means.

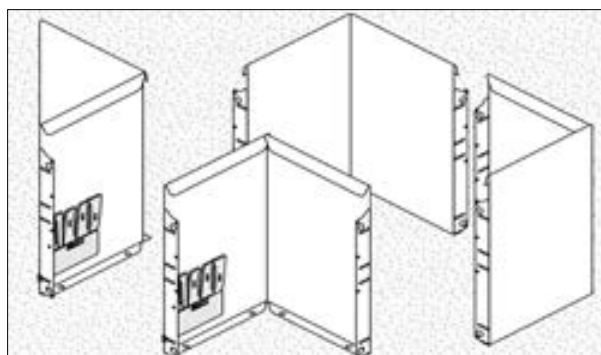

MAKING YOUR OWN CORNERS

To make a corner yourself you will need to use an angle grinder. Be sure to operate safely with all suitable gear.

1. Mark a vertical line down the back of the edge directly beneath a top edge notch space where the corner fold is needed. With the angle grinder score the line in three places sufficiently to create a fold line.
2. Also cut a gap in the top lip and remove a bottom foot tab on one side of the fold line to allow room for bending in.
3. Bend strongly by hand; using a block of wood close to the fold to form the bend against helps.

For reverse corners (~270°) a fold line will need to be cut in as above. Also make a neat notch cutout in the back of the folded lip to aid the bend. No other cuts are required.

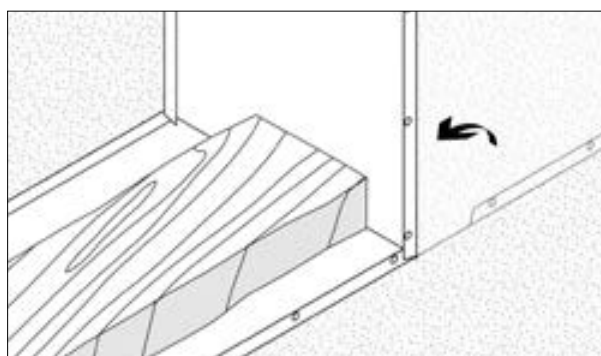
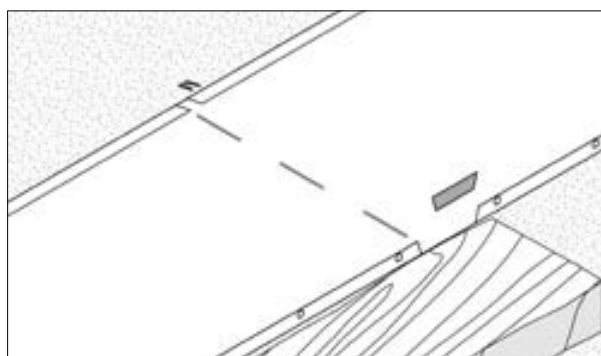

CURVE CAPABILITIES

In terms of curve capabilities, the 400mm Rigid Raised Garden Bed Panel barely curves. With care, you can achieve a 26m radius without distortion using this product.

Bracing methods

BRACING ON VARIOUS HARD SURFACES

The Universal Bracing Sets are best suited for these conditions. Simply fit the turnbuckle with cable or chain to the pre-fitted bracing ribs and anchor back to the ground. Alternatively, the 1100mm ground anchor sets can be used on hard surfaces that allow a post hole.

1. The stake that comes with the Universal Bracing Set is of a star picket style and will penetrate very hard surfaces, as do the fixing spikes that lock in the feet.
2. On concrete, a bolt down method can be used in place of the stake, anchoring the cable or chain with a DynaBolt™. Bolt the foot holes in place with an 8mm DynaBolt™, but first introduce packers to raise it slightly for drainage.

TIP : When using the Universal Bracing Sets, securing the anchor point to alternative structures such as walls or fences is also a workable solution.

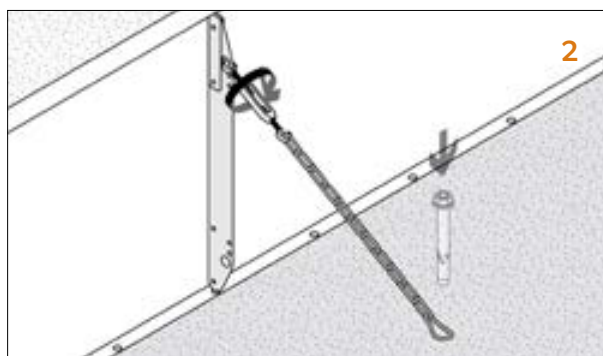
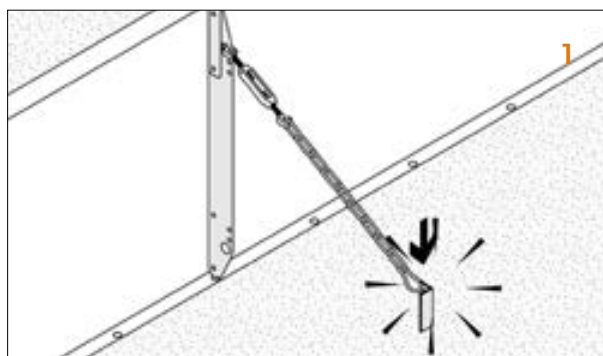

HOW TO MOVE A BRACING RIB

If bracing rib is located above an obstacle preventing staking at that position or where access is difficult it can be moved. Firstly, remove the bracing rib by knocking it laterally near the top with a hammer until loose. It can then be refitted in a new place, inserting the base portion into a bottom foot tab hole first, and then tapping the upper part of the bracing rib with a hammer to return it to a vertical position tight behind the top lip.

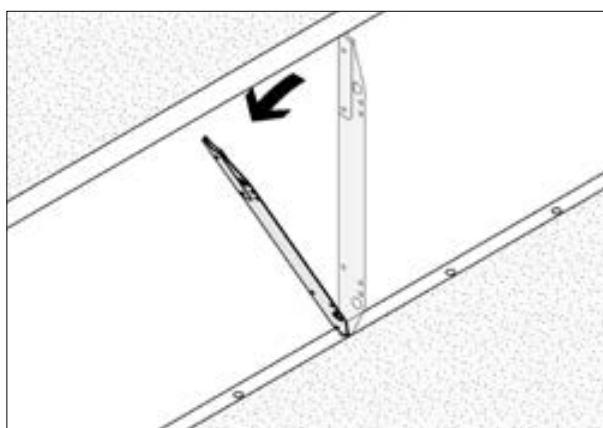

CREATING CONNECTION TABS OF YOUR OWN

The folded back flange on the end of a panel may be used to fix one end to a wall or other solid feature. Simply bolt or screw as appropriate to fix it strongly. When the edge panel is too long for this method you can use an angle grinder to make a fold back 'join tab' of your own. Remove the top lip portion, then create the fold back by the score and bend method. That tab can then be screwed internally to the surface it meets, which is sometimes another piece of Straightcurve®!

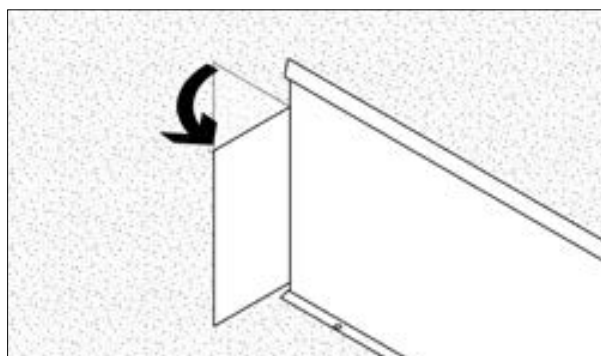
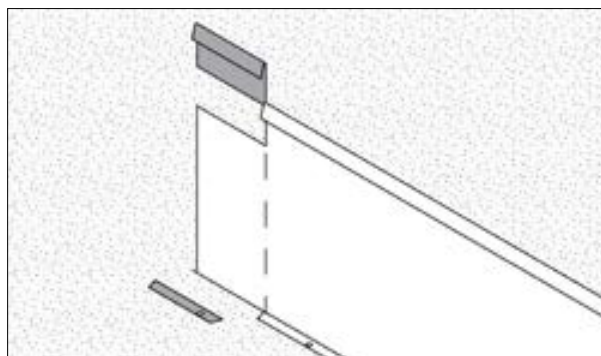

COMPATIBILITY AND WORKING ON SLOPES

1. The 400mm Rigid Raised Garden Bed Panel is compatible with the 400mm Flex Raised Garden Bed Panels. This allows them to work in combination. In fact, join slots align across all Rigid or Flex panels (400/400/560mm) so that a continuous top edge occurs if different heights are joined together.
2. This across height compatibility can be used to advantage with Raised Garden Beds on a slope. On the lower part of the slope the Raised Garden Bed run may need taller panels with a greater edge face visible due to the slope falling away, with panels of lesser height required further up the bank. It takes some careful planning, but can look very effective, adding volume and height to a bed while reducing the amount of steel used in the project overall.

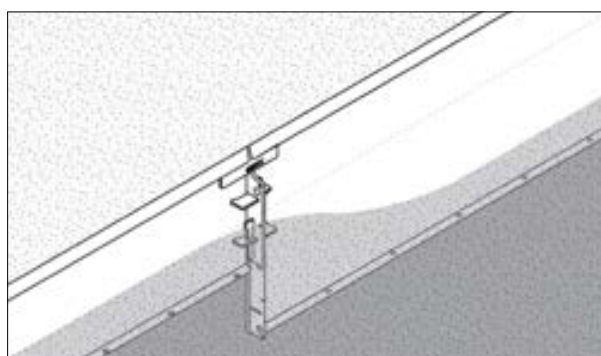
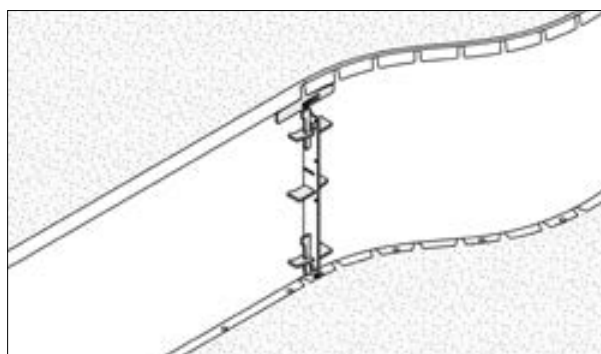

HOW TO USE A CUTBACK PANEL

If a length has been shortened with an angle grinder the join flange is then lost. To allow this piece to still be used the Join Part For Offcuts is simply screwed to the cutaway end (through guide holes in join part). This then overlays the length it is joining, and further screwing sees both panels neatly connected.

This overlay join part does mean screws are visible on the face of the Raised Garden Bed, but it is helpful with perimeters that require a part length to meet or when making regular shaped beds where the side length is predetermined. It also means no offcuts are wasted!

Some tips here are to either place the join part in the least conspicuous spot and use Zinc Screws which blend in as they rust over (for Weathering Steel), or make a feature of it by adding more join parts to create a pattern. With that approach, you may even choose to substitute polished bolt heads in place of the discreet screws.

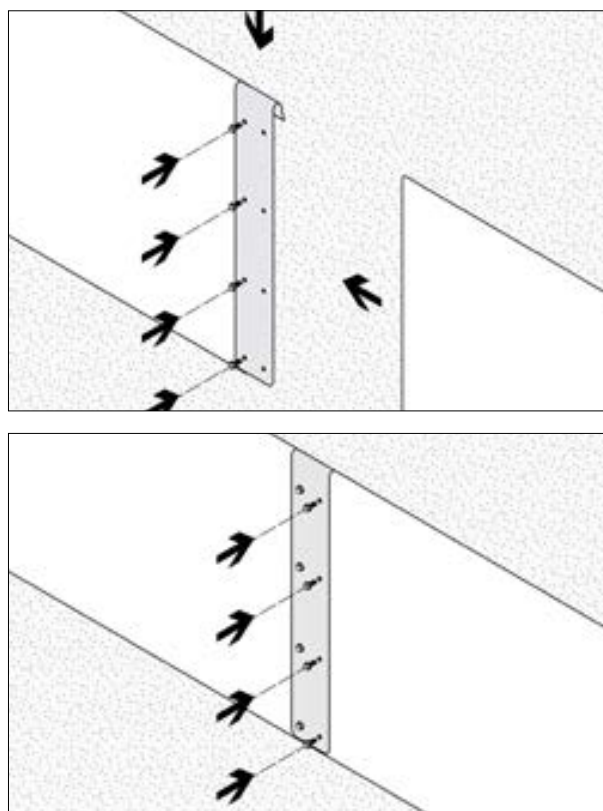

Straightcurve[®] Zero-Flex Raised Garden Bed Panel - 400mm

FHL400-400/600/800/1000/1200/2000WS WEATHERING STEEL
FHL400-400/600/800/1000/1200/2000GS GALVANISED STEEL

Product features

The details that make the difference



Option 1 (D): Universal bracing set with turnbuckle for fast, easier bracing; hooks into bracing rib.

Option 2 (D): Ground anchor set for alternative bracing method; fitting set joins post to panel at top and foot

Full Face Above Ground instead of burying the edge.
Discreet Join Seams for a stylish finish.



Angular top profile and foot for Zero Flex performance
Round edge square tops for child & pet safety

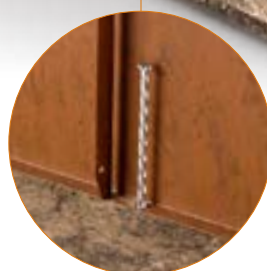

Moveable Fixing Spikes for easy obstacle avoidance



Precision engineered joint sets for fast, no weld method

EDGE STYLE



FINISHES

- Galvanised Steel
- Weathering Steel

For lasting, perfectly straight unmovable lines

Product specifications

TECHNICAL SPECIFICATIONS

Panel Lengths	400/600/800/1000/1200/2000 mm
Top edge thickness	46mm
Steel plate thickness	2mm
Weight per panel	3.5/5.0/6.6/8.2/9.7/15.8kg

BULK BUYING

Pack quantity	10
Bulk pack weight	35/50/66/80/97/158kg



JOIN SETS ARE REQUIRED

- A** Straight join set (panels in a line) *
- B** Closed corner set (standard 90°, right angle) *
- C** Reverse Corner set (270°, L-shapes) *

*All require Tek screws, select from above to suit configuration

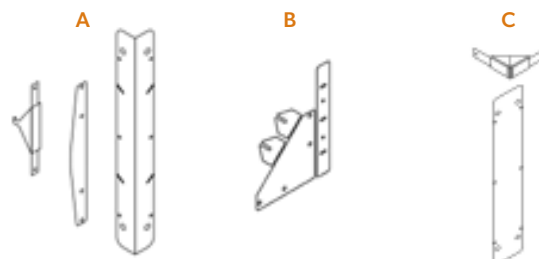

ADDITIONAL ACCESSORIES

REQUIRED

- D** Universal bracing set as ground anchor post alternative (turnbuckle/cable or chain/T-stake)
- E** Fixing spikes, galvanised, 300mm long
 - 2 for 400/600/800mm panels
 - 3 for 1000/1200/2000mm panels

OPTIONAL

- F** Ground anchor set - 1100mm, use one for every straight join/one extra for 2000mm panel midpoint
- G** Bracing Rib for 2000mm panels only (allows use of universal bracing set)
- H** Bracing strap set (used with opposing straight joins no wider than 1200mm apart only)

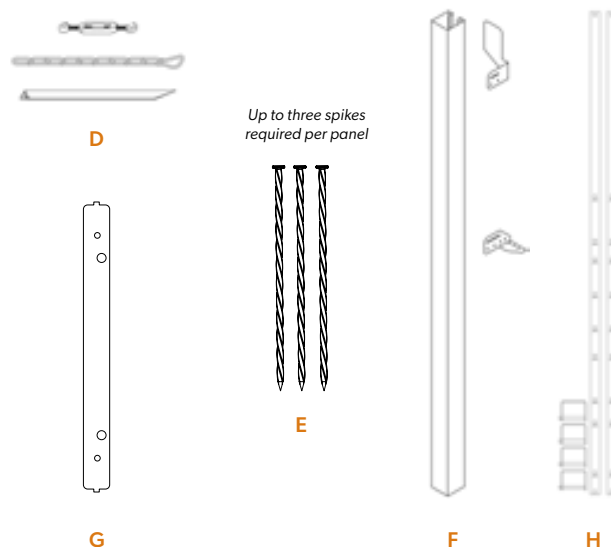

Up to three spikes required per panel

Creating XL planter box style raised garden beds

For Raised Garden Beds that look like really big planter boxes simply create your very own bespoke configurations using multiple Zero-Flex panels.

Cross bracing with the bracing strap set works when opposing straight joins are 1200mm or less apart. This means a free standing bed can be created with this internal bracing approach. The bracing strap set accommodates different widths up to 1200mm, and is simply snapped off for the correct span (repeatedly bend back and forth to snap point) and fitted between the available lock in holes.

For raised garden beds wider than 1200mm the cross bracing strap set is too short, so either a universal bracing set or a ground anchor set -1100mm (includes fitting set) can be used to brace each straight join.

L-shapes and U-shaped beds are also pretty easy once planned out, see how best to approach this below...



Choosing the right panels, join sets & accessories

In four easy steps

Step 1: Sketch out your raised garden bed shape including dimensions of all sides.

Step 2: Measure up - On your sketch, mark out all panel sizes required to build your design. Note: Straightcurve® planter panels are available in 400mm, 600mm, 800mm, 1000mm, 1200mm and 2000mm long lengths to make up a 'nearest to' option.

Step 3: Jot down the number of panels of each length needed for your design. Do the same for joining accessories (circle each panel join and tally the number of straight joins, closed corners, and reverse corners required)

Step 4: Brace it right - each straight join in your design will require bracing. Use one bracing strap set where two opposing joins are equal to or less than 1200mm apart. In all other situations, use one universal bracing set (or ground anchor post 1100mm + fitting set) per straight join. Make a note of how many of each type of bracing you need on your sketch.

Note the join sets bring the panels snug together, but manufacturing tolerances mean what you get may be marginally longer than expected. Be careful with tight spaces!

*see what panel sizes are locally available or if lead times apply for any panel sizes, prior to planning.

We've sketched some examples for you →

Raised garden bed ideas...

MOST POPULAR

- Panels (1200) = 6
- Panels (600) = 2
- Closed Corners = 4
- Straight joins = 4
- Bracing Straps Set (BSS) = 2

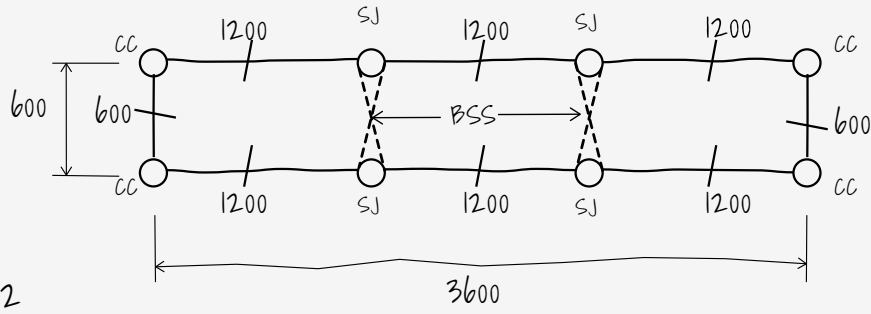

GET FUNKY

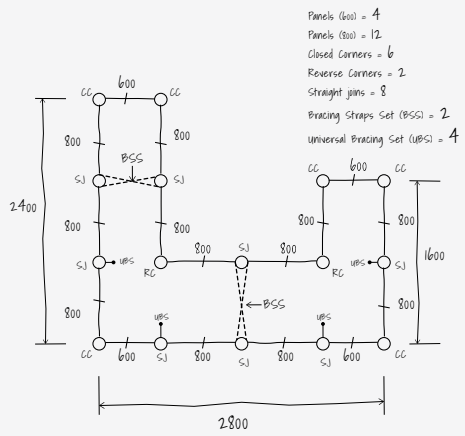
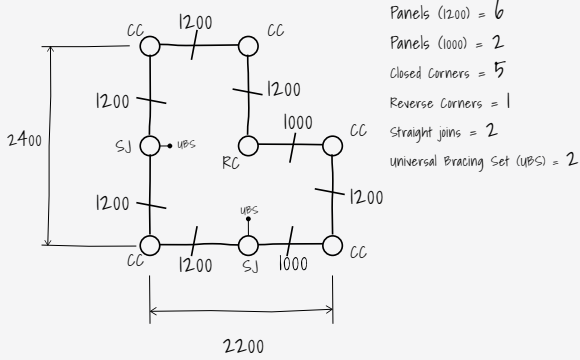

GREAT FOR CORNERS

- Panels (400) = 5
- Panels (800) = 3
- Panels (1200) = 1
- Closed Corners = 4
- Reverse Corners = 3
- Straight joins = 1
- Universal Bracing Set (UBS) = 1

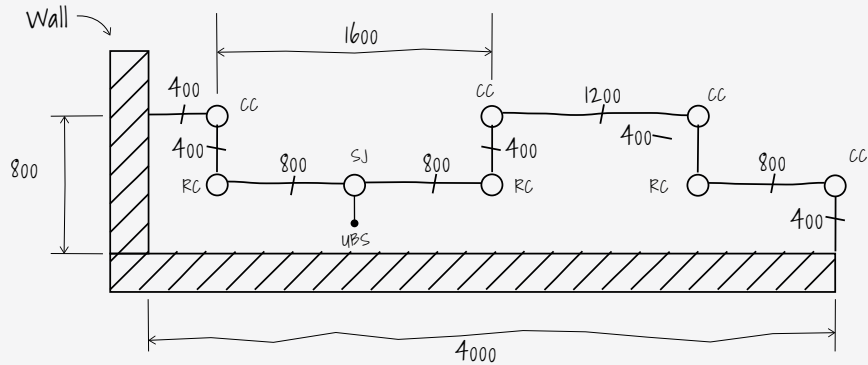

- Panels (600) = 12
- Closed Corners = 5
- Reverse Corners = 1
- Straight joins = 6
- Bracing Straps Set (BSS) = 2
- Universal Bracing Set (UBS) = 2

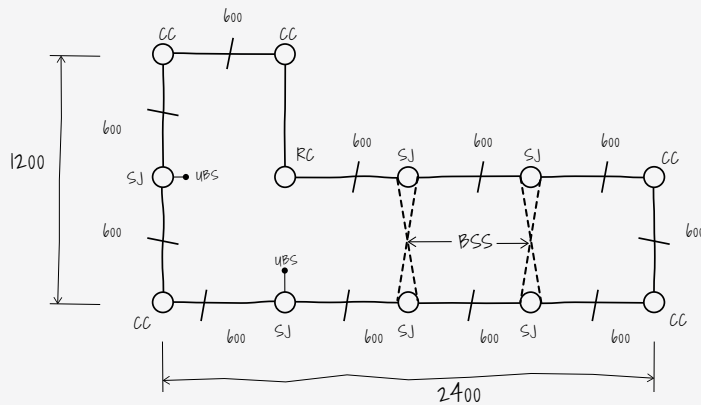

400mm Zero-Flex Raised Garden Bed Panel™

Standard Installation Process

REQUIRED FIXINGS

- Straight join set
10 x Tek Screws (12G x 16mm)
- Closed corner set
6 x Tek Screws (12G x 16mm)
- Reverse corner set
6 x Tek Screws (12G x 16mm)
- Ground anchor set -1100mm
6 x Tek Screws (12G x 16mm)

RECOMMENDED TOOLS

- Ground leveling tools
- Metal hammer
- Cordless drill and Tek screw bit
- Pliers

PREPARATIONS

The Zero-Flex Raised Garden Bed requires NO digging in as it is fixed at the feet to the ground surface. The ground should be level for the edge to sit flush on during installation. Any obstructions should be removed or re-routed. It can be installed on all level ground types including concrete surfaces (where packers are used to sit edge off ground to allow drainage).

DO...

- ✓ Check the line with a string line before fixing the base.
- ✓ Use join set parts in the stepped order recommended
- ✓ Get the top join pieces to sit just right before screwing tight
- ✓ Brace near to or at all straight joins
- ✓ If installing on a hard surface line the bed to prevent grit spillage
- ✓ Set drill speed to high when drilling into ground anchor posts

DON'T...

- ✗ Set directly onto a hard surface without raising slightly with packers for drainage
- ✗ Forget to stake/brace any straight joins or ends
- ✗ Accelerate rust with acids or salts (but soapy water is ok!)
- ✗ Try and use pop rivets, requires Tek screws for strength
- ✗ Forget the safety gloves when working with steel!

MARKING OUT AND SECURING ASSEMBLED GARDEN BEDS

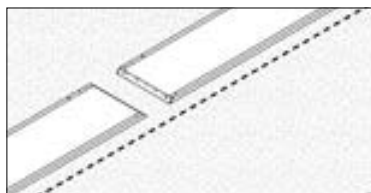

MARKING SHAPE - Mark edge line or use string line on flat ground and layout edge pieces nearby. All panels will now require joining by way of joining option A, B or C.

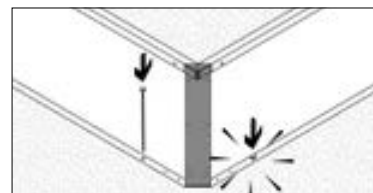

SECURING TO GROUND - Once ALL the panels are joined and in the exact finishing position use fixing spikes to secure base through holes in foot.

STAKING / BRACING FOR SUPPORT - Will be required and two methods are explained in following pages.

BACKFILL - Evenly to complete the project once staking/bracing is done.

(A) STRAIGHT JOIN

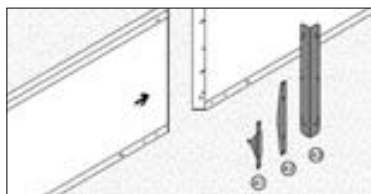

STEP 1 - For a straight join (two panels in a line) use the Straight Join Set (A). Separate the pieces in the set.

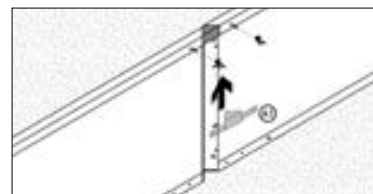

STEP 2 - Stand the first two panels together on a flat surface and insert top connector piece (A1), align guide holes and screw.

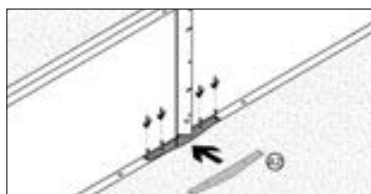

STEP 3 - Slide in foot joiner (A2), align guide holes and screw.

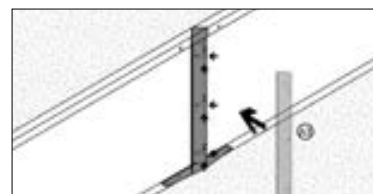

STEP 4 - Fit back rib (A3) flush to align guide holes and screw.

Scan or click to watch install video

▶ INSTALL GUIDE



75mm

100mm

150mm

240mm

400mm

560mm

Planter boxes

(B) RIGHT ANGLE CORNER (90°)

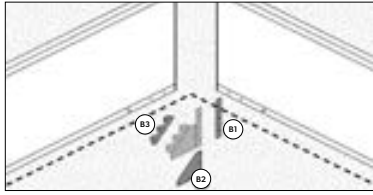

STEP 1 - When creating a standard right angle corner (90°) use the Corner Join Set (B). Break apart the pieces in the set.

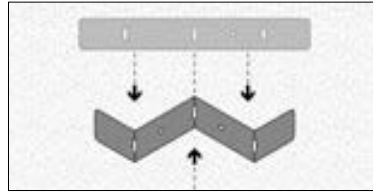

STEP 2 - Take strip piece (B1) and use pliers to shape into staircase pattern.

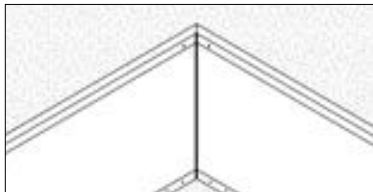

STEP 3 - Stand the two panels at right angles to each other and butt together.

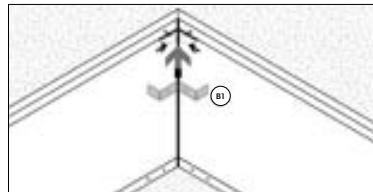

STEP 4 - To join - insert top connector 'staircase' piece (B1), align guide holes and screw.

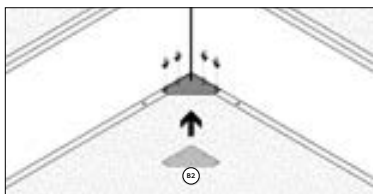

STEP 5 - Slide in foot joiner (B2), align guide holes and screw.

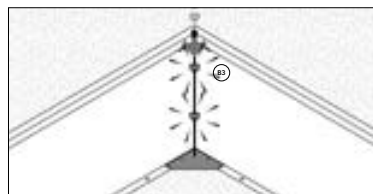

STEP 6 - Firmly grip and hammer arrow shaped wedge pieces (B3) into angled slots at back to fully secure the join.

(C) REVERSE CORNER (L SHAPE BED)

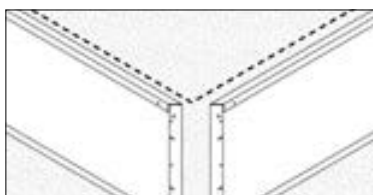

STEP 1 - For a reverse corner stand the two panels in the L shape formation and butt them together.

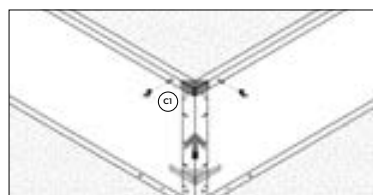

STEP 2 - From the reverse corner join set (C), insert (slide in) the top piece (C1) as shown and align guide holes and Tek screw in place.

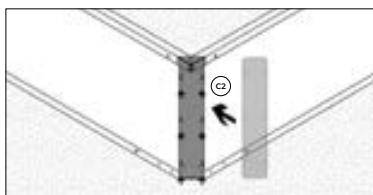

STEP 3 - Position the back fixing plate (C2) align and Tek screw through guide holes to secure.

BRACING THE PANELS

ALL straight joins and garden bed ends will require bracing.
Either:

1. Use Universal Bracing Set to hook into top hole in join rib and anchor to the ground, adjusting tension with the turnbuckle. For the middle of the 2000mm panels there is no such point of attachment, but bracing is needed. In this case, insert the bracing rib for 2000mm panels in the middle of the panel and attach the universal bracing set to this fitted bracing rib
OR
2. Use Grounding Anchor Set -1100mm adjacent straight joins and at wall ends (also an alternative method to brace middle of 2000mm length panels). Fitting set is used to attach post to bottom foot and behind top fold of the panel.

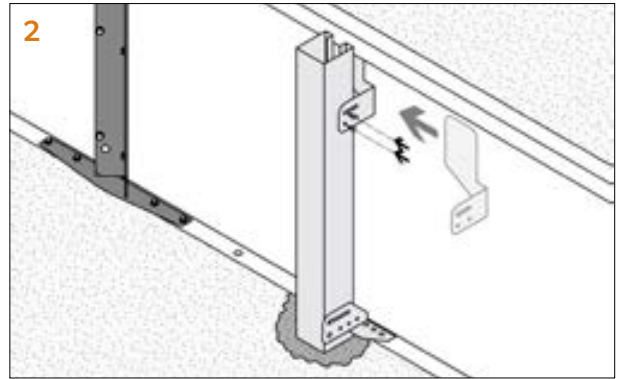
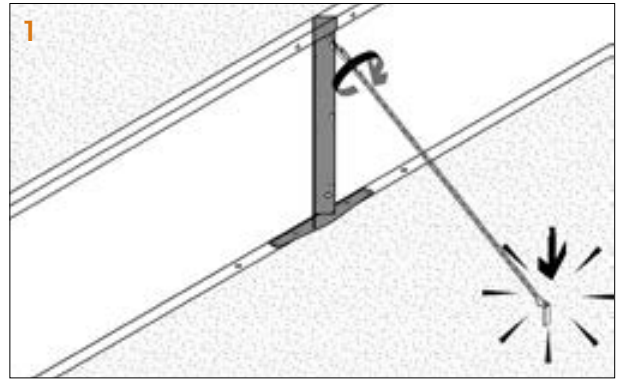

HARD SURFACE BRACING & USING BRACING STRAPS

In these situations use the Universal Bracing Sets. Fit the turnbuckle with cable or chain to the straight joins through hook-in holes and anchor with the stake supplied.

1. The stake that comes with the Universal Bracing Set is of a star picket style and will penetrate very hard surfaces, as do the fixing spikes that lock in the feet.
2. On concrete, a bolt-down method can be used in place of the stake, anchoring the cable or chain with a DynaBolt™ (A). Bolt the foot holes in place with an 8mm DynaBolt™ (B), but first introduce packers to raise it slightly for drainage.
3. If you can't penetrate the surface at all you can create a free standing Raised Garden Bed or use our four panel planter boxes that require no lock down. For free standing raised garden beds with straight joins that are no wider than 1200mm, opposing straight joins can be braced with our cross bracing straps running between them. These are simply attached as crossover diagonal straps that run from the top of both straight joins to the bottom of the opposite straight join. Note that the bracing strap only works between two straight joins, so when a straight join is opposite a reverse corner (as in an L-shape design) the universal bracing set is required for that straight join.

TIP: When using the Universal Bracing Sets, securing the anchor point to alternative structures such as walls or fences is also a workable solution. Use more rather than less chain length when the install space allows this.

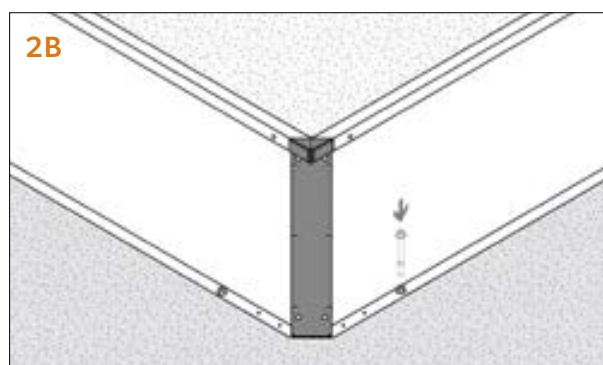
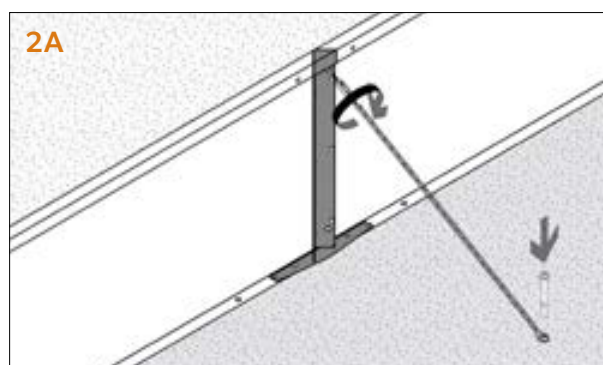
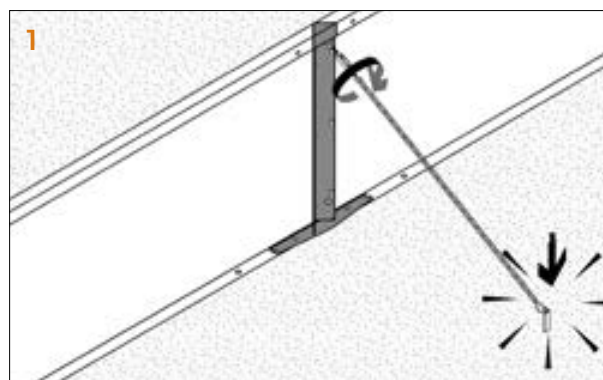

MAKING DIFFERENT HEIGHT RAISED GARDEN BEDS

The Zero-Flex raised garden beds look great in combination, with different heights placed together. They are not join compatible between heights, so the way to do this is to build them as separate raised garden beds and then butt them together or position them in proximity. A perfectly level base would be key to achieving this look.

SPECIAL CASE - USING A 2000MM PANEL

These panels are the longest available and will require a ground anchor set at the midpoint as well as where straight joins occur. If using the Universal Bracing Set at the panel midpoint, the dedicated bracing rib needs to be purchased to allow attachment of the turnbuckle.

Technical Drawings

75mm

100mm

150mm

240mm

400mm

560mm

Planter boxes

STRAIGHTCURVE® FLEX RAISED GARDEN BED PANEL - 400MM

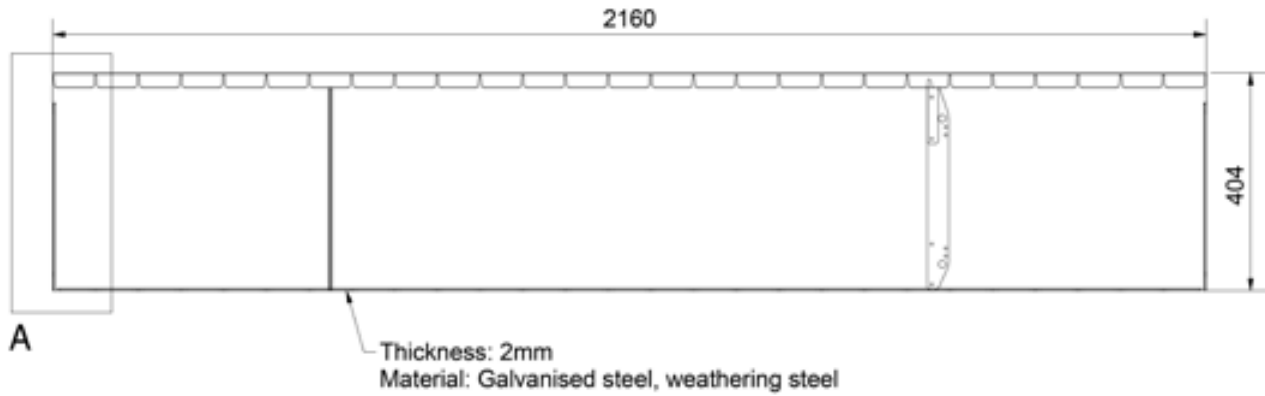

STRAIGHTCURVE® RIGID RAISED GARDEN BED PANEL - 400MM

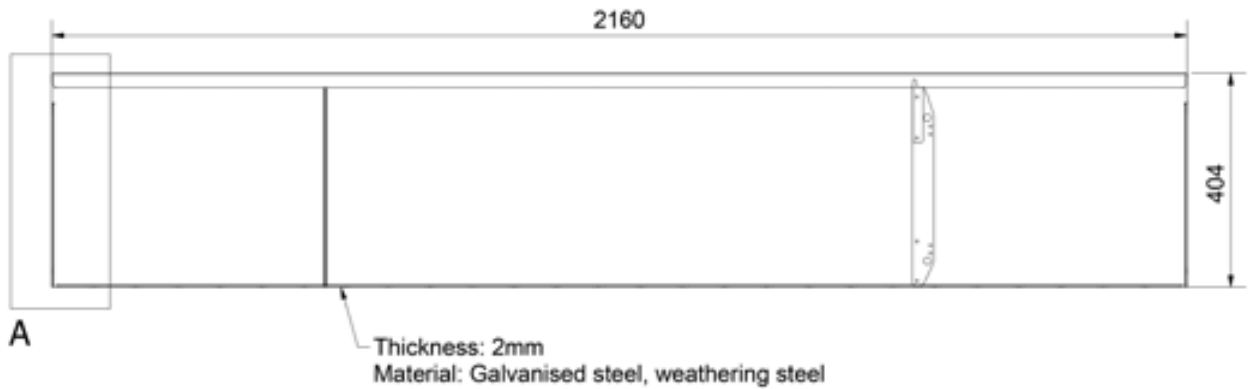

UNIVERSAL SPECIFICATIONS

SIDE PROFILE/JOIN FLANGE

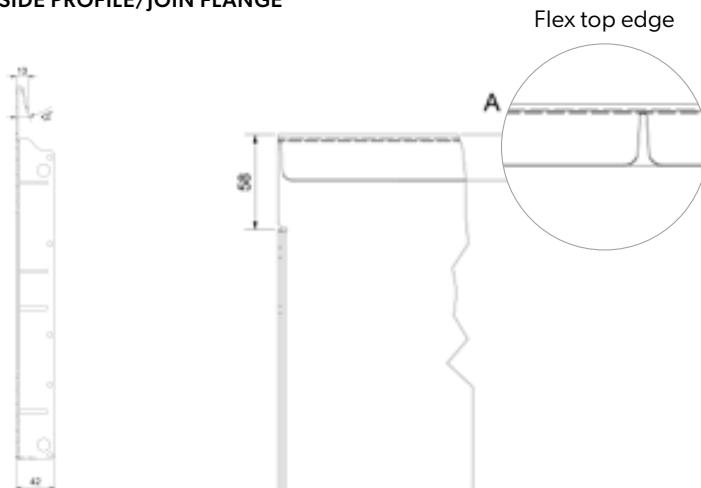



75mm

100mm

150mm

240mm

400mm

560mm

Planter boxes

STRAIGHTCURVE® ZERO-FLEX RAISED GARDEN BED PANEL - 400MM

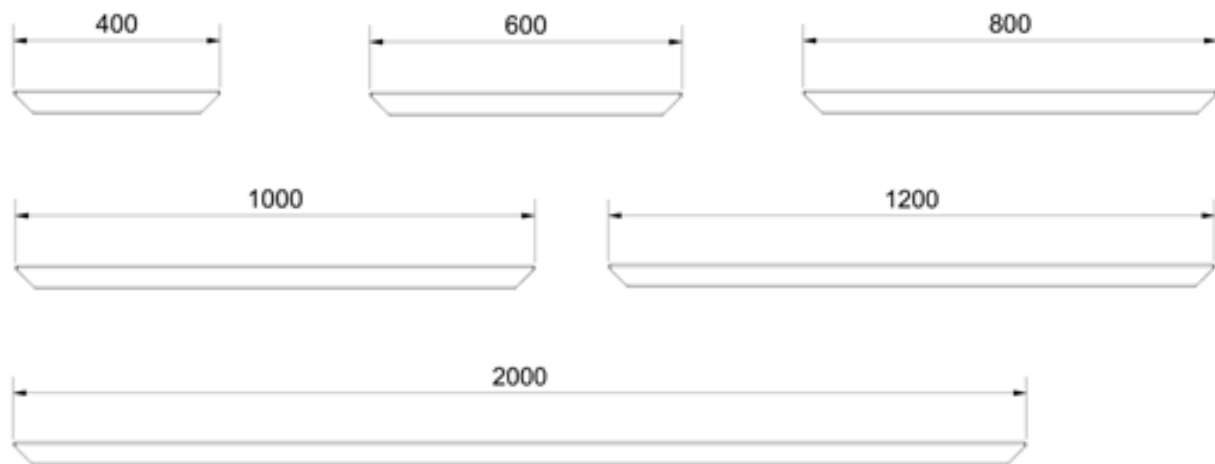

PANEL END/JOIN FLANGE

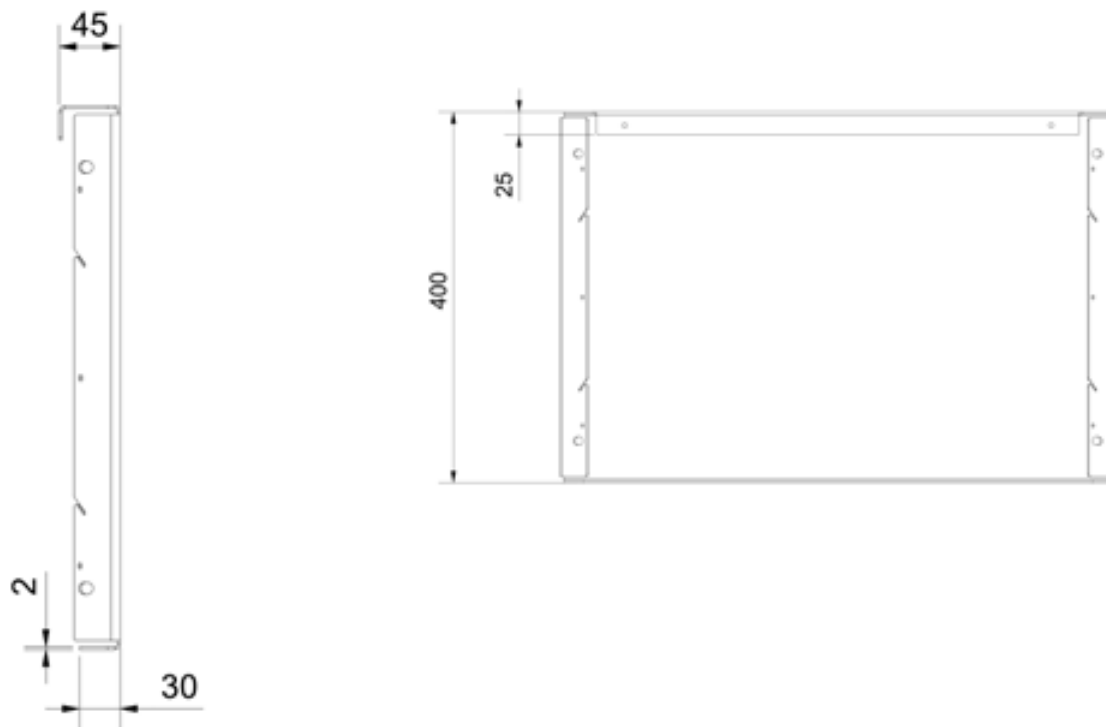

NOTE: Foot holes not shown in these diagrams are of 9mm diameter

560mm Raised Garden Beds

For curved and straight Raised Garden Bed situations.

Do you know what Raised Garden Bed product is best for your project? Let's figure that out together here!

Use these edges as

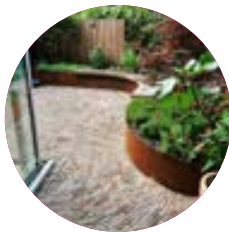

RAISED GARDEN BEDS
Raised Garden Bed borders

OR



FEATURE RAISED GARDEN BEDS
Closed shape garden beds

OR



LOW RETAINING & TERRACED BEDS
Access on a sloping block

Perhaps it looks something like these?



Straightcurve® Flex Raised Garden Bed - 560mm



Straightcurve® Zero-Flex Raised Garden Bed - 560mm

How do you choose the 560mm Raised Garden Bed that's best for you?

We have solutions for curved and straight Raised Garden Bed situations. Use the below table to consider which is the best option from our range for your project. It's your call and we hope these recommendations makes it easier!

I'm looking for...	We recommend for this ...		
	 Flex - 560	 Rigid - 560	 Zero-Flex - 560
Something I can do myself	✓	✓	✓
A super high-quality raised garden bed that's stylish and strong	✓	✓	✓
Something flexible enough to make both tight and gentle curves with ease	✓	✗	✗
Tree rings	✓	✗	✗
Something rigid that helps me to create a straight run	✗	✓	✓
A straight edge that will stay true and won't waver	✗	✗	✓
An edge ideal for linear designs with plenty of corners	✗	✗	✓
Something with a square shaped top edge making it appear boxy	✗	✗	✓

How about this!? It's also possible to combine styles, as our Flex Raised Garden Bed panels and Rigid Raised Garden Bed panels are join and profile compatible.

Product overview

ROUNDED TOPS AND SAFETY FEATURES

The smooth, rounded tops and edges assist safe handling. When installed, all joins/fixings are internal so that the exposed top and front present as a smooth top edge and continuous fascia.

SAFER AND CLEANER HANDLING

We recommend wearing gloves as the manufacturing process can leave residual oils/dust and our products can get hot when exposed to sunlight. Our products are shipped in bundles, when lifting bundles handlers should be mindful of their carrying capabilities. Single items are easy to carry for one person (see product weights).

ABOUT WEATHERING STEEL

The manufacturing process of weathering steel leaves the surface in a dark, almost black state. This dark 'finish' is an oxide layer that forms during the hot rolling process. The weathering process needs to break this layer down first before the desired protective patina layer can be established. You can expect some inconsistency in the patina formation because the thickness of the oxide layer varies; it'll appear spotty with some areas going orange and others still black.

The patina develops naturally with periods of wet and dry, and both phases are key for its steady formation. Do not wet continually without allowing time for thorough drying. A faster patina formation can be aided by cleaning the surface with soapy water to remove oil residue, but anything harsher is not advised as it can be detrimental to patina development and consequently, reduce product lifespan. Some rust solution products are safe to use as these 'build a surface patina' rather than just accelerating rusting.

WHAT IS A PATINA

Patina is not the same as rust. All rust is patina, but not all patina is rust. Patina is a chemical bond between various elements and usually oxygen. It can be found on most metals with the exception of 8 inert (noble) metals like gold or silver. 'Normal' rust is iron-oxide, the patina referred to above is mostly a bond between copper, phosphorus, chromium, nickel, iron and oxygen. You may wonder, how does water feature in it? Water acts as an electrolyte, but

that's a different story. In the end, the patina formed on weathering steel is a dense layer that doesn't flake or allow oxygen through. Therefore, once formed, the oxidation process slows down dramatically.

WILL THE STEEL STAIN MY PAVERS OR DECK?

This can occur in the early stages of rusting but can be avoided with care, such as by protecting nearby surfaces while the patina establishes. The worst cases of this you will see involves mild steel because the rusting carries on unabated. With weathering steel this should only happen when first developing a patina or if rushed artificially (sped up with acids/salts) to achieve faster colour change. What you can do as an excellent strategy is pre-rust the edging before installing to have a stable early phase patina there already. This doesn't need to take long if you procure a rust solution recommended for steady patina formation.

LONGEVITY

Our products are of the highest quality ensuring longevity in the given environment. For further information please refer to the "Longevity Guide" and "Product Care Guide" on our website.

PAINTING, SEALING AND POWDERCOATING

Our galvanised products are suited to painting, but the surface should be thoroughly prepared (using acetone wash), and sealed with a metal primer (etch primer is very good) to maximise topcoat adhesion.

Powdercoating is a much more durable/hardy choice, and can be requested for large projects with lead times/costings supplied. It is worth noting that not all powdercoating performs the same, we use and recommend Interpon powder from AkzoNobel for assured quality and maximum endurance and suggest you request the same. It's also worth asking first to see a sample from your chosen powdercoater specialist. Note that, As for painting, galvanised products should be used whenever powdercoating.

75mm

100mm

150mm

240mm

400mm

560mm

Planter boxes

Another question we get relates to freezing the colour (or patina development) at a certain stage. That's possible using a transparent sealant suitable for steel. Keep in mind that the colour will change when applying a sealant, it'll get a 'wet' look. Be sure to test this in a small inconspicuous area first before fully committing. This will require reapplication once a year.

WHEN IS CONCRETING AROUND THE ANCHORS AND FIXING SPIKES NECESSARY?

For an install on sandy/soft/shifting ground conditions it's important to set the foot-stabilising galvanised fixing spikes and ground anchor stakes or posts into some concrete for extra hold. If you're not sure about the ground condition, the firmness of the subsurface ground when the spikes are hammered in is a good indicator as to whether concreting is needed; they need to gain purchase and feel rigid. The 560mm Raised Garden Beds experience a considerable outward force acting upon them so if in doubt, use some concrete.

HOW TO POSITION THE EDGE

"These Raised Garden Beds have a front facing side with discreet joint seams, while the back side retains the actual garden fill, meaning all joints and bracing systems are hidden.

Be mindful also that a garden bed can settle at lower than the install levels and may require topping up later to maintain the look initially achieved with your Raised Garden Bed. This top up practice can also increase lifespan, as the protective patina formation may be inconsistent in previously buried portions.

HOW DEEP DO I BURY THE EDGE?

For all these products there is no need to bury the edge. Traditionally, it has been necessary to bury upto one third of the panel when using steel for raised garden beds, but the lockdown foot design means that is not required and you get to see the full face of the panel. You effectively get the same result as the old ways, with a third less steel!

That said, sometimes these products are used as a partly buried raised garden bed edge. This is particularly effective in sloping situations where the ground meeting the edge is not level, so the degree of panel showing changes along the run of the raised garden bed.

WHY DO WE SUPPLY AND RECOMMEND TEK SCREWS?

When fixing the ground anchor sets to the edge use Tek screws for their self-tapping (self-drilling) abilities. This is an easy, fast and strong method. The long lasting, grey Dacromet Tek screws are best for all the buried screw locations of these products.

ADVANTAGES

- ✓ Continuous smooth top square or rounded edges
- ✓ Corners available or easily made in situ with Flex and Rigid lines
- ✓ Up to 3x faster installation
- ✓ No welding required
- ✓ No burying the edge required
- ✓ No Experience/training needed
- ✓ Designed for ease of use

Straightcurve® Flex Raised Garden Bed Panel - 560mm

FL560WS WEATHERING STEEL | FL560GS GALVANISED STEEL

Product features

The details that make the difference

Wedge and slider join system for a faster, stronger no weld method



Full face visible instead of burying the edge. Discreet join seams for a stylish finish

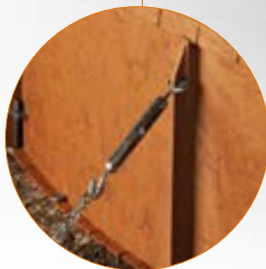
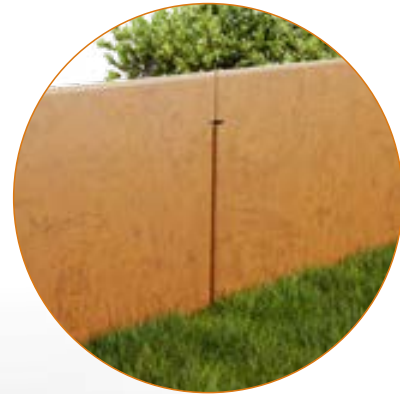

Universal bracing set with turnbuckle for fast, easier bracing



Movable fixing spikes for easy obstacle avoidance



Notched top and feet for smooth, even curves

8mm rounded tops for child and pet safety

75mm

100mm

150mm

240mm

400mm

560mm

Planter boxes

EDGE STYLE



FINISHES

- Galvanised Steel
- Weathering Steel

For smoothly curving Raised Garden Beds that look great and hold position once shaped & installed.

Product specifications

TECHNICAL SPECIFICATIONS

Length	2160mm
Top edge thickness	8mm
Steel plate thickness	2mm
Weight per length	22kg

BULK BUYING

Pack quantity	10
Bulk pack weight inc. pallet	236kg

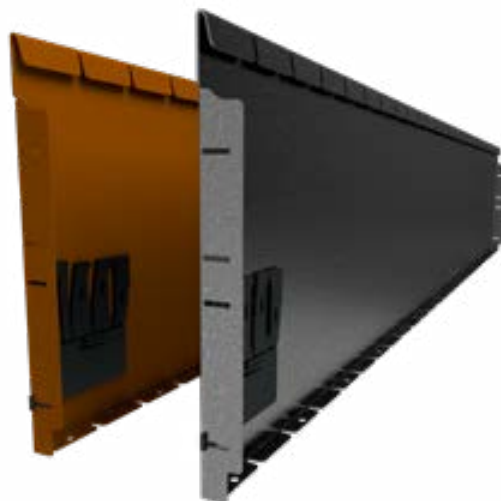

SOLD AS SET INCLUDING

- Joining set includes 1 X join bracket (A), 3 x slider (B), 3 x wedge (C)
- 5 x Fixing spikes, galvanised, 300mm long
- 2 x bracing ribs (attached to panel/movable)

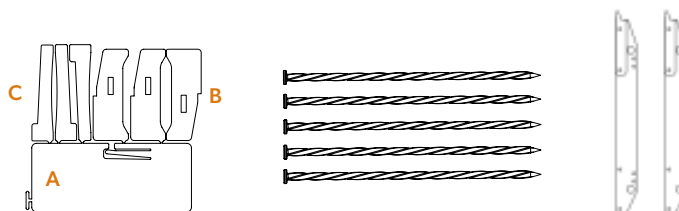

ADDITIONAL ACCESSORIES

REQUIRED

- D** Universal bracing set as ground anchor post alternative (turnbuckle/cable or chain/T-stake)

OPTIONAL

- E** Corner piece (90° right angle / arm lengths: 255mm)
- F** Reverse corner piece (270° L-shape / arm lengths: 255mm)
- G** Ground anchor set - 1100mm (Tek screws required)
- H** Join part for offcuts (Tek screws required)

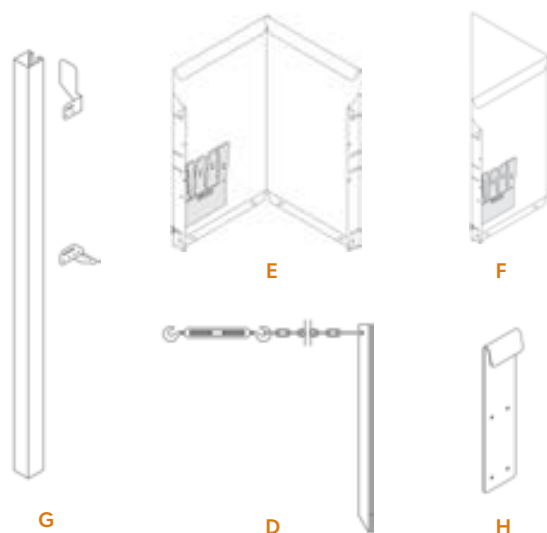

Flex Raised Garden Bed Panel - 560mm Installation Guide

Scan or click to watch install video



REQUIRED FIXINGS

- Ground anchor set
6 x Tek Screws (12G x 16mm)
- Join part for offcuts
10 x Tek Screws (12G x 16mm/ zinc colour for WS)

RECOMMENDED TOOLS

- Ground leveling tools
- Metal hammer
- Rubber mallet
- Cordless drill and Tek screw bit (for accessories **G** and **H**)
- Angle grinder (required if modifying lengths or fashioning corners/ends)

PREPARATIONS

The Flex Raised Garden Bed requires NO digging in as its feet are secured to the ground surface. The base should be smoothed/ leveled for the edge to sit flush on the ground during installation. Any obstructions should be removed or re-routed. It can be installed on all level ground types including concrete surfaces (where packers are used to sit edge off ground to allow drainage). It is useful to have some cardboard or board to place under joins when connecting with the panel face down on flat ground. Grass and debris likes to get caught in the tight seam!

DO...

- ✓ Join all lengths in place and perfect the line before finally fixing in position.
- ✓ If using a pre-made corner start from there and work back.
- ✓ Score an intermittent line rather than one deep score line if making corners.
- ✓ Follow the instructions carefully and do it with a friend if making a two panel ring.
- ✓ For circular beds backfill evenly for equal outward pressure.

DON'T...

- ✗ Use for straight lines, instead use Rigid Or Zero-Flex options.
- ✗ Forcibly bend. Take care and gently flex the edge to shape.
- ✗ Forget to stake or brace your edge once joined unless making circular beds (less than 3m diameter).
- ✗ Accelerate rust with acids or salts (but soapy water is ok!)

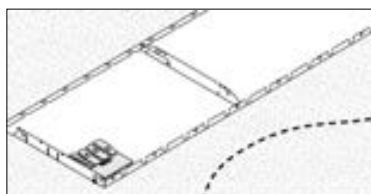

STEP 1 - Mark edge line on ground and layout edge pieces nearby.

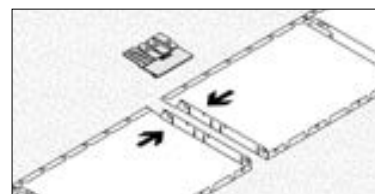

STEP 2 - Place first two edges front face down on the ground with ends touching and with join slots aligned.

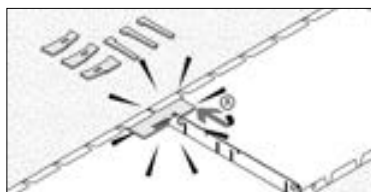

STEP 3 - Join using the joining set, break the pieces apart first by hand and insert join bracket (**A**) securely under the top lip (centred). Press it against back of panels (use a metal hammer to firmly lock in).

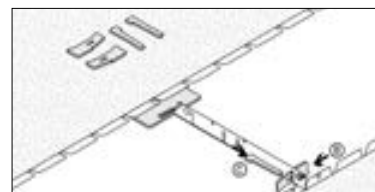

STEP 4 - Next, insert a slider (**B**) through adjacent bottom slots with its 'feet' against the edge. Knock it through fully so wedge (**C**) can insert and lock in the slider.

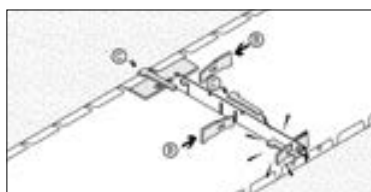

STEP 5 - Hammer the wedge in firmly. Repeat step 4 for middle and top slot using the remaining wedge and slider sets.

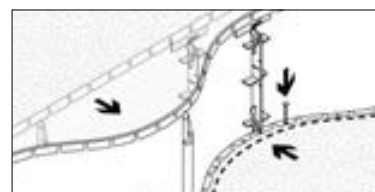

STEP 6 - Set these two edges upright and flex to position where desired, use fixing spikes as temporary placeholders.

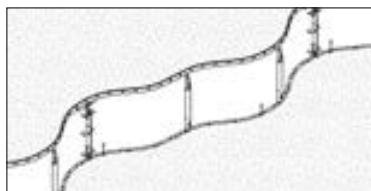

STEP 7 - Introduce and join further lengths (or joined pairs of lengths), butting them against the now standing edge, connecting them as you go.

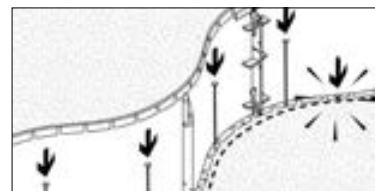

STEP 8 - Check the line, then hammer all fixing spikes (5 per length) through foot tab holes

CHOOSE YOUR BRACING METHOD

UNIVERSAL BRACING (TURNBUCKLE/CABLE OR CHAIN/T-STAKE)

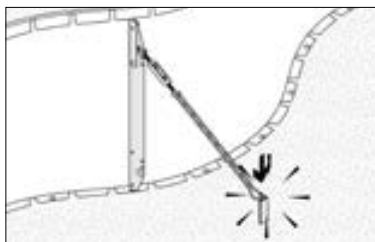

STEP 9A.1 - Using the universal bracing set, hammer in the anchoring stake and connect to bracing rib with cable or chain and turnbuckle taut.

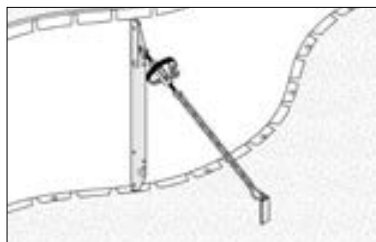

STEP 9A.2 - The turnbuckle is then used for fine vertical adjustment.

ANCHORING SET

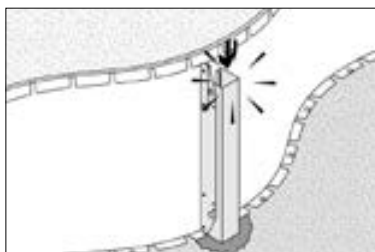

STEP 9B.1 - To stake, hammer to ground anchor post in tightly adjacent a bracing rib and close against the bottom foot.

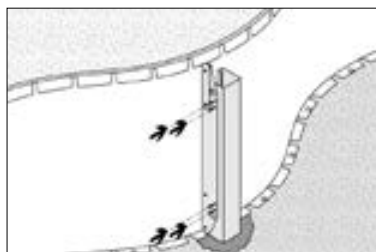

STEP 9B.2 - Screw the ground anchor post 1100 to the bracing rib with tek screws through guide holes.

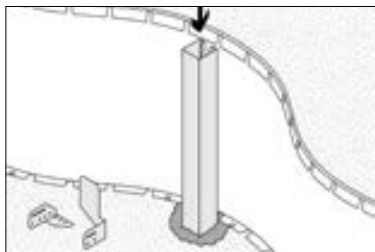

STEP 9C.1 - Alternatively brace with ground anchoring set-1100mm. These posts are installed flush against back of edge.

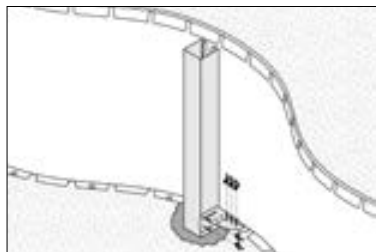

STEP 9C.2 - Once posts in position, screw the fitting set foot piece through guide holes to join the post and edge at the foot.

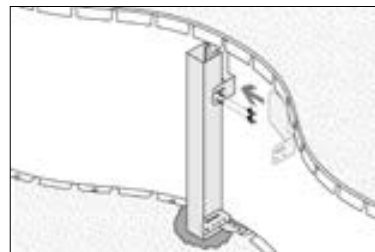

STEP 9C.3 - Fitting the top piece allows adjustment of the vertical, check carefully before final screwing to post.

CONTINUE TO FINISH

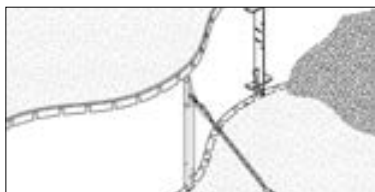

STEP 10 - Back fill your Raised Garden Bed to finish.

Creating corners

PRE-MADE CORNERS

Pre-made corners with 255mm long arms are available for purchase and include the standard joining set. There is a standard 90 degree right angle corner and a reverse corner for turnbacks such as when making an L-shape. It's difficult, but the angle of these pre-made corners can be adjusted by applying considerable force using ratchet straps or other means.

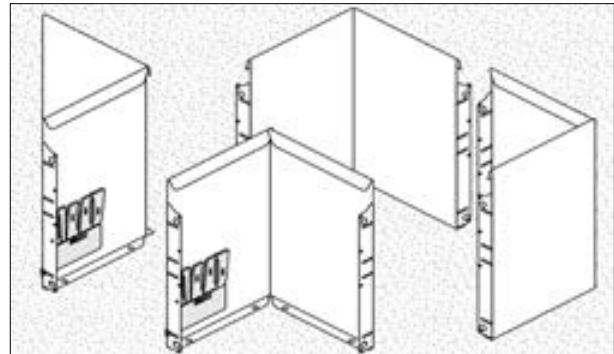

MAKING YOUR OWN CORNERS

To make a corner yourself you will need to use an angle grinder. Be sure to operate safely with all suitable gear.

1. Mark a vertical line down the back of the edge directly beneath a top edge notch space where the corner fold is needed. With the angle grinder score the line in three places sufficiently to create a fold line.
2. Also cut a gap in the top lip and remove a bottom foot tab on one side of the fold line to allow room for bending in.
3. Bend strongly by hand; using a block of wood close to the fold to form the bend against helps.

For reverse corners (~270°) a fold line will need to be cut in as above. Also raise the height of the notch groove to the top of the lip neatly to aid the bend. No other cuts are required.

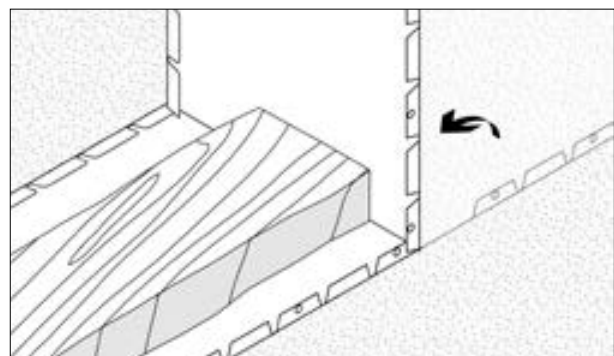
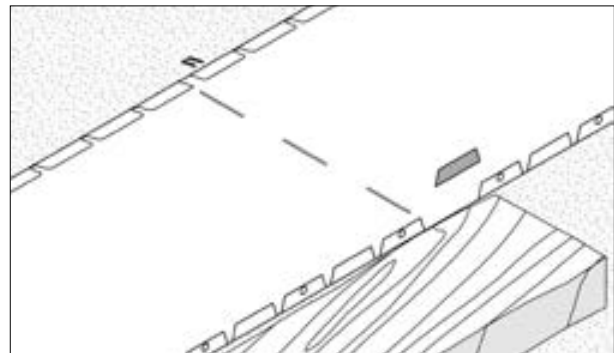

Creating circles

CIRCLES & CURVE CAPABILITIES

Connecting edge panels makes standard ring sizes. Design for complete edge lengths of 2 or more to give the desired diameter. Here's our standard sizes.

Standard Circle diameters

No. of panels:	2	3	4	5
Diameter:	1.37m	2.06m	2.75m	3.44m

In terms of curve capabilities, the 400mm Flex Raised Garden Bed Panel has a minimum radius achievable of around 700mm. It is designed to allow this degree of flex and no more. This is also why you cannot make a ring with one panel, the two panel ring is the smallest possible. If the Raised Garden Bed face makes a concave curve the back of the join flanges can gap slightly. To counter this, there are some pilot holes at the back edge of the join flange. Screw through these with Tek screws before creating the concave curve.

HOW TO MAKE A TIGHT CIRCLE (D:1370MM) WITH TWO EDGE PANELS.

Require 5m ratchet strap and sturdy rectangular board (recommend 600-1200mm wide X edge height).

This construction is best done with two people.

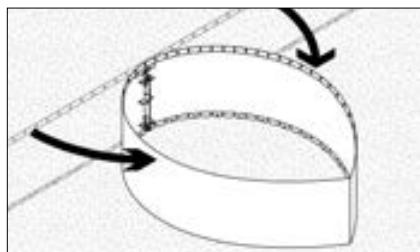

STEP 1 - Connect two panels with joining set, then pull ends in to meet in teardrop shape.

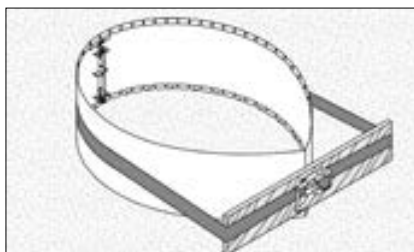

STEP 2 - Place ratchet strap around midriff and over the board, with the board positioned to pull in open end.

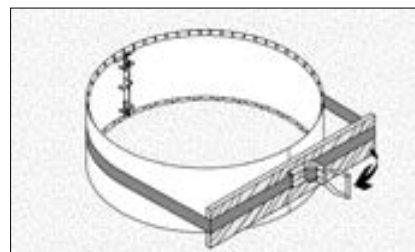

STEP 3 - Ratchet in until ends are flush, and fully align join flanges with gradual ratcheting.

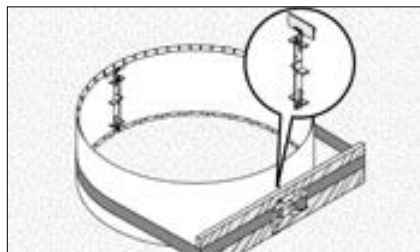

STEP 4 - When the edge end join flanges align perfectly, use joining set to lock together.

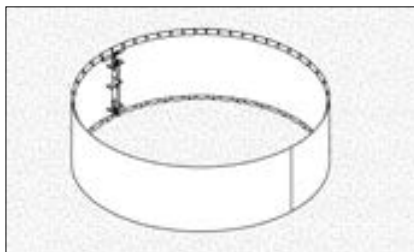

STEP 5 - Release ratchet and unstrap, it will be slightly oval in shape.

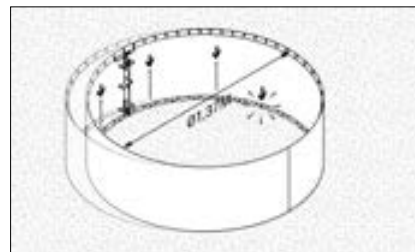

STEP 6 - Correct by hand to desired ring shape, measuring diameter (1.37m) and pin the feet to hold as you go. Use a rubber mallet to finesse shape.

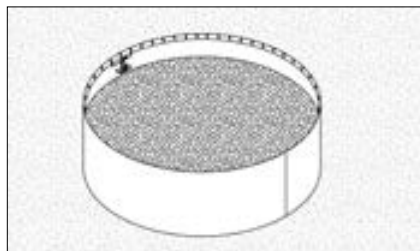

STEP 7 - That done, fill evenly, there is no need for bracing this self supporting circle.

Note: For three or more panels, two people can simply pull into shape and connect, without the need for ratchet approach

Bracing methods

BRACING ON VARIOUS HARD SURFACES

The Universal Bracing Sets are best suited for these conditions. Simply fit the turnbuckle with cable or chain to the pre-fitted bracing ribs and anchor back to the ground. Alternatively, the 1100mm ground anchor sets can be used on hard surfaces that allow a post hole.

1. The stake that comes with the Universal Bracing Set is of a star picket style and will penetrate very hard surfaces, as do the fixing spikes that lock in the feet.
2. On concrete, a bolt down method can be used in place of the stake, anchoring the cable or chain with a DynaBolt™. Bolt the foot holes in place with an 8mm DynaBolt™, but first introduce packers to raise it slightly for drainage.

TIP: When using the Universal Bracing Sets, securing the anchor point to alternative structures such as walls or fences is also a workable solution.

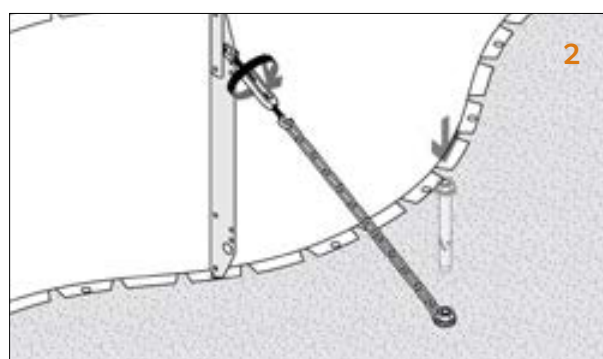
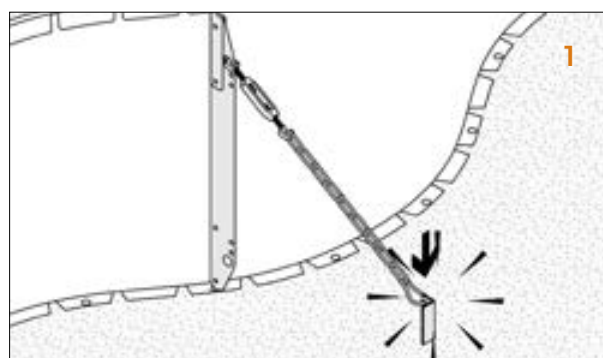

HOW TO MOVE A BRACING RIB

It's easy to move the bracing rib if it is located above an obstacle preventing staking there or where access to the rib will be difficult. Simply loosen and remove the bracing rib by knocking it sideways near the top with a hammer. It can then be refitted in a new place, inserting the base nub into a bottom foot tab hole first, and then tapping the upper part of the bracing rib with a hammer firmly to return it to a vertical position tight behind the top lip.

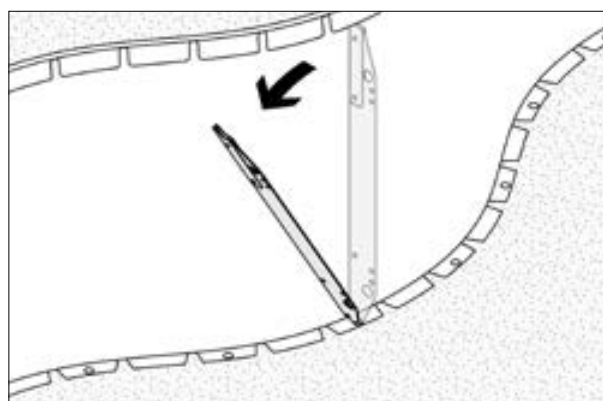

CREATING CONNECTION TABS OF YOUR OWN

To fix one end to a wall or other solid feature you can fix the folded back flange on the end of the panel to that surface. Simply bolt or screw as appropriate to fix it strongly.

If the edge panel is too long to do that, you can both shorten and create a join tab at the same time with your angle grinder. To do so measure carefully first, then remove the extra top lip portion and create the fold back piece by the score and bend method as shown. The tab can then be screwed internally to the surface it meets, which is sometimes another piece of Straightcurve®!

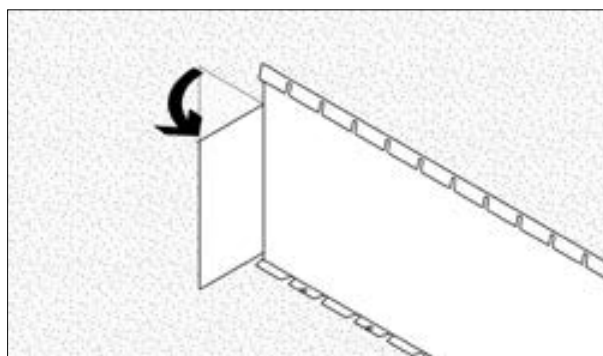
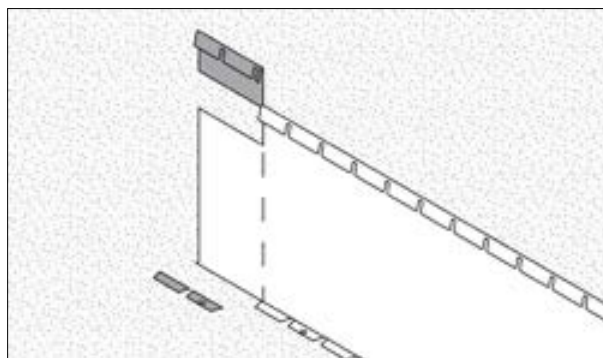

COMPATIBILITY AND WORKING ON SLOPES

1. The 560mm Flex Raised Garden Bed Panel is compatible with the 560mm Rigid Raised Garden Bed Panels. This allows them to work in combination.
2. In fact, join slots align across all Flex or Rigid panels (240/400/560mm) so that a continuous top edge occurs if different heights are joined together. This across height compatibility can be used to advantage with Raised Garden Beds on a slope. On the lower part of the slope the Raised Garden Bed run may need taller panels with a greater edge face visible due to the slope falling away, with panels of lesser height required further up the bank. It takes some careful planning, but can look very effective, adding volume and height to a bed while reducing the amount of steel used in the project overall.

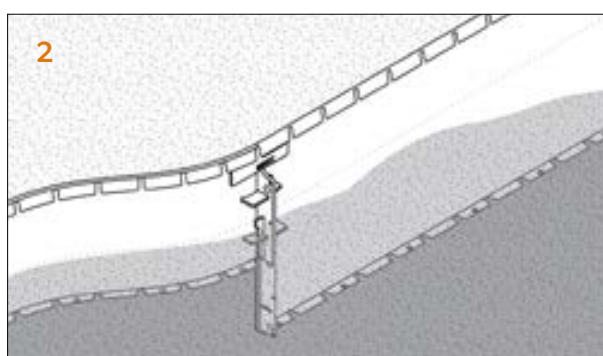
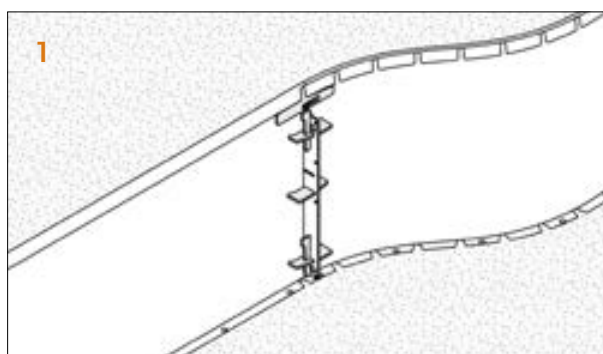

HOW TO USE A PANEL OFFCUT

When a length is shortened with an angle grinder it loses the join flange. To solve that problem we have a Join Part For Offcuts. This is simply screwed to the cutaway end (through guide holes in join part) and overlays the length it is joining. Further screwing sees both panels neatly connected.

This overlay Join Part does mean screws are visible on the face of the Raised Garden Bed, but it is helpful with perimeters that require a part length to meet or when making regular shaped beds where the side length is predetermined. It also means no offcuts are wasted!

Some tips here are to either place the join part in the least conspicuous spot and use Zinc Screws which blend in as they rust over (for Weathering Steel), or make a feature of it by adding more Join Parts to create a pattern. With that approach, you may even choose to substitute polished bolt heads in place of the discreet screws.

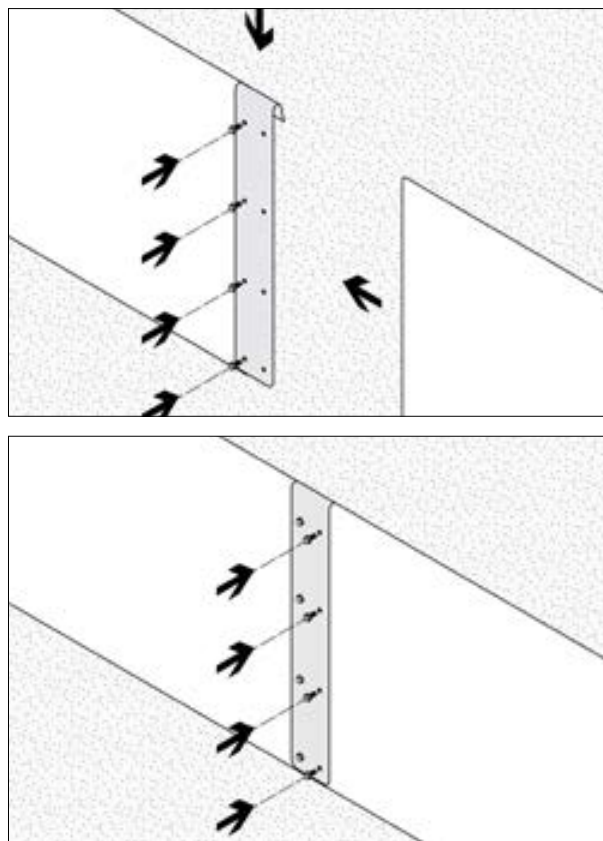

75mm

100mm

150mm

240mm

400mm

560mm

Planter boxes

Straightcurve® Rigid Raised Garden Bed Panel - 560mm

RL560WS WEATHERING STEEL | RL560GS GALVANISED STEEL

Product features

The details that make the difference

Wedge and slider join system for a faster, stronger no weld method



Full face visible instead of burying the edge. Discreet join seams for a stylish finish

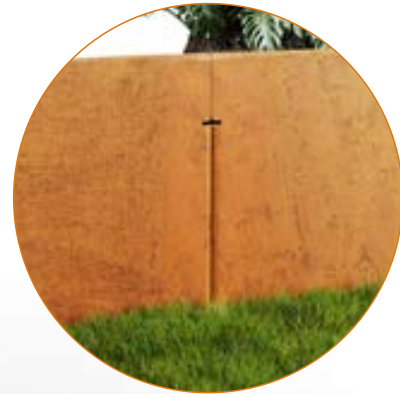

Universal bracing set with turnbuckle for fast, easier bracing



Movable fixing spikes for easy obstacle avoidance



Continuous Fold Top and Foot for rigid straight lines

8mm rounded tops for child and pet safety

75mm

100mm

150mm

240mm

400mm

560mm

Planter boxes

EDGE STYLE



FINISHES

- Galvanised Steel
- Weathering Steel

For Raised Garden Beds
with straight edges

Product specifications

TECHNICAL SPECIFICATIONS

Length	2160mm
Top edge thickness	8mm
Steel plate thickness	2mm
Weight per length	22kg

BULK BUYING

Pack quantity	10
Bulk pack weight inc. pallet	236kg



SOLD AS SET INCLUDING

- Joining set includes 1 X join bracket (A), 3 x slider (B), 3 x wedge (C)
- 5 x Fixing spikes, galvanised, 300mm long
- 2 x bracing ribs (attached to panel/movable)

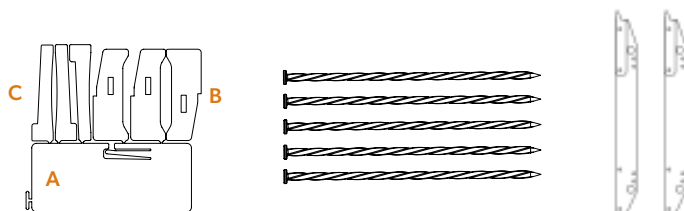

ADDITIONAL ACCESSORIES

REQUIRED

- D** Universal bracing set as ground anchor post alternative (turnbuckle/cable or chain/T-stake)

OPTIONAL

- E** Corner piece (90° right angle / arm lengths: 255mm)
- F** Reverse corner piece (270° L-shape / arm lengths: 255mm)
- G** Ground anchor set - 1100mm (Tek screws required)
- H** Join Part for Offcuts (Tek screws required)

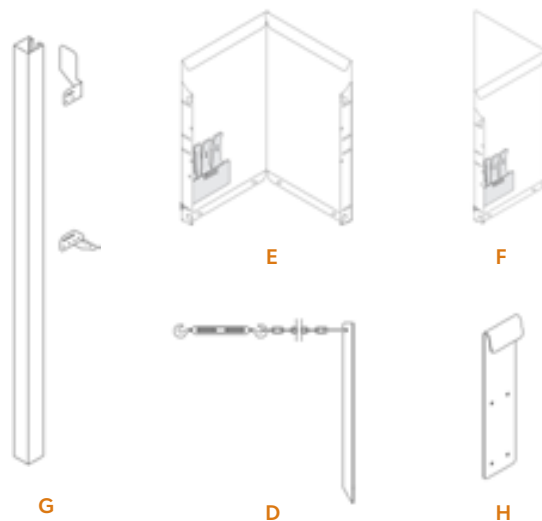

Rigid Raised Garden Bed Panel - 560mm Installation Guide

Scan or click to watch install video



REQUIRED FIXINGS

- Ground anchor set
6 x Tek Screws (12G x 16mm)
- Join part for offcuts
8 x Tek Screws (12G x 16mm/ zinc colour for WS)

RECOMMENDED TOOLS

- Ground leveling tools
- Metal hammer
- Rubber mallet
- Cordless drill and Tek screw bit (for accessories **G** and **H**)
- Angle grinder (required if modifying lengths or fashioning corners/ends)

PREPARATIONS

The Rigid Raised Garden Bed requires NO digging in as its feet are secured to the ground surface. The base should be smoothed/ leveled for the edge to sit flush on the ground during installation. Any obstructions should be removed or re-routed. It can be installed on all level ground types including concrete surfaces (where packers are used to sit edge off ground to allow drainage). It is useful to have some cardboard or board to place under joins when connecting with the panel face down on flat ground. Grass and debris likes to get caught in the tight seam!

DO...

- ✓ Check the line with a string line as you add more panels.
- ✓ If using a pre-made corner start from there and work back.
- ✓ Score an intermittent line rather than one deep score line if making corners

DON'T...

- ✗ Use for curved line designs, instead use Flex Raised Garden Bed
- ✗ Forcibly bend if aiming for a mild curve of a radius exceeding 26m
- ✗ Forget to stake or brace your edge once joined
- ✗ Accelerate rust with acids or salts (but soapy water is ok!)

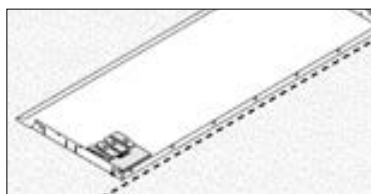

STEP 1 - Mark edge line on ground and layout edge pieces nearby.

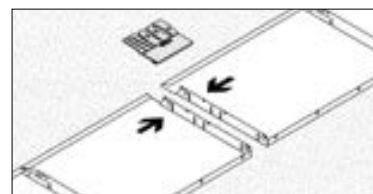

STEP 2 - Place first two edges front face down on the ground with ends touching and aligned.

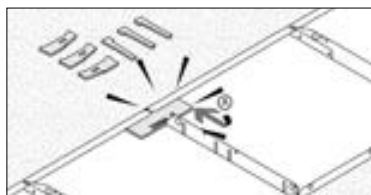

STEP 3 - Join using the joining set, break the pieces apart first by hand and insert join bracket (**A**) securely under the top lip (centred). Press it against back of panels (use a metal hammer to firmly lock in)

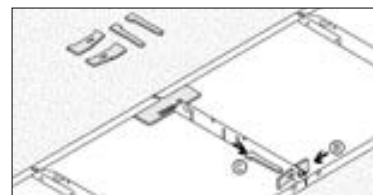

STEP 4 - Next, insert a slider (**B**) through adjacent bottom slots with its 'feet' against the edge. Knock it through fully so wedge (**C**) can insert and lock in the slider.

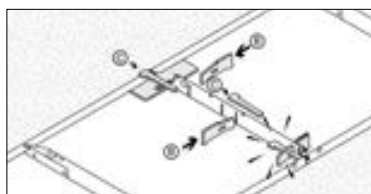

STEP 5 - Hammer the wedge in firmly. Repeat step 4 for middle and top slot using the remaining wedge and slider sets

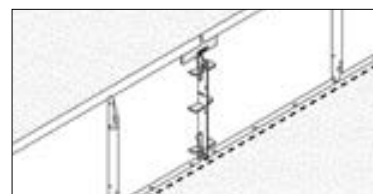

STEP 6 - Set these two edges upright and position where desired

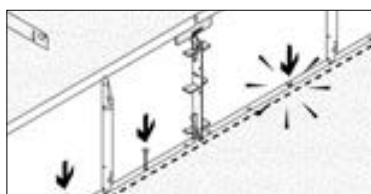

STEP 7 - Check the line, then hammer all fixing spikes (5 per length) through foot tab holes

75mm

100mm

150mm

240mm

400mm

560mm

Planter boxes

CHOOSE YOUR BRACING METHOD

UNIVERSAL BRACING (TURNBUCKLE/CABLE OR CHAIN/T-STAKE)

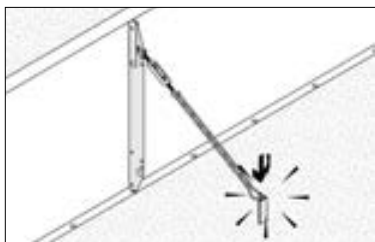

STEP 8A.1 - Using the universal bracing set, hammer in the anchoring stake and connect to bracing rib with cable or chain and turnbuckle taut.

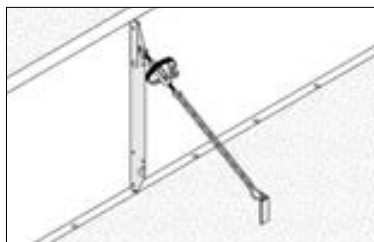

STEP 8A.2 - The turnbuckle is then used for fine vertical adjustment.

ANCHORING SET

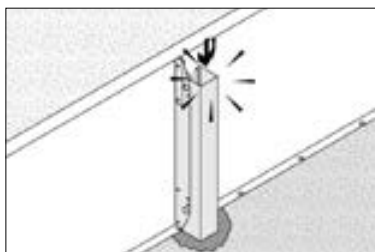

STEP 8B.1 - To stake, hammer to ground anchor post in tightly adjacent a bracing rib and close against the bottom foot.

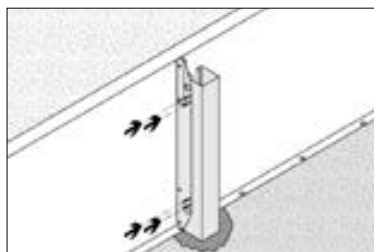

STEP 8B.2 - Screw the ground anchor post 1100 to the bracing rib with tek screws through guide holes.

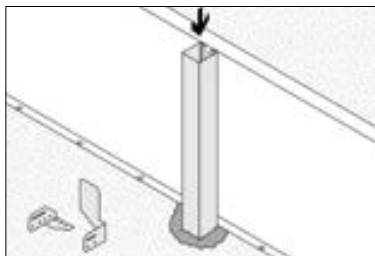

STEP 8C.1 - Alternatively brace with ground anchoring set-1100mm. These posts are installed flush against back of edge

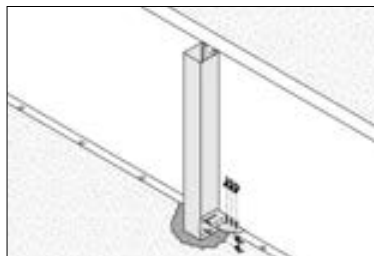

STEP 8C.2 - Once posts in position, screw the fitting set foot piece through guide holes to join the post and edge at the foot

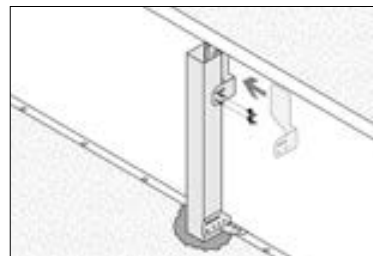

STEP 8C.3 - Fitting the top piece allows adjustment of the vertical, check carefully before final screwing to post

CONTINUE TO FINISH

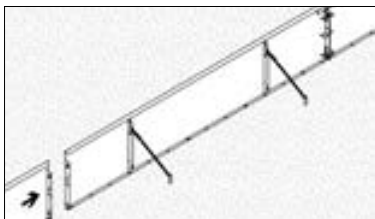

STEP 9 - Introduce further lengths (or joined pairs of lengths), butting them against the now standing edge and connecting them and bracing them as you go.

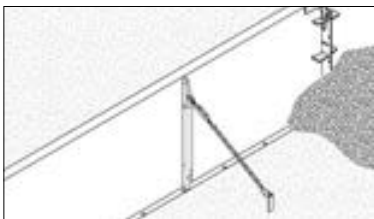

STEP 10 - Back fill your Raised Garden Bed to finish.

Creating corners

PRE-MADE CORNERS

Pre-made corners with 255mm long arms are available for purchase and include the standard joining set. There is a standard 90 degree right angle corner and a reverse corner for turnbacks such as when making an L-shape. It's difficult, but the angle of these pre-made corners can be adjusted by applying considerable force using ratchet straps or other means.

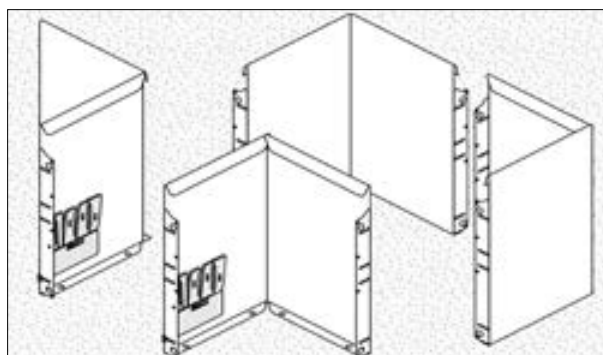

MAKING YOUR OWN CORNERS

To make a corner yourself you will need to use an angle grinder. Be sure to operate safely with all suitable gear.

1. Mark a vertical line down the back of the edge directly beneath a top edge notch space where the corner fold is needed. With the angle grinder score the line in three places sufficiently to create a fold line.
2. Also cut a gap in the top lip and remove a bottom foot tab on one side of the fold line to allow room for bending in.
3. Bend strongly by hand; using a block of wood close to the fold to form the bend against helps.

For reverse corners (~270°) a fold line will need to be cut in as above. Also make a neat notch cutout in the back of the folded lip to aid the bend. No other cuts are required.

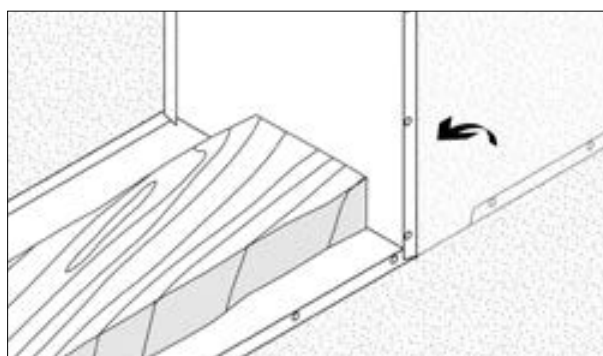
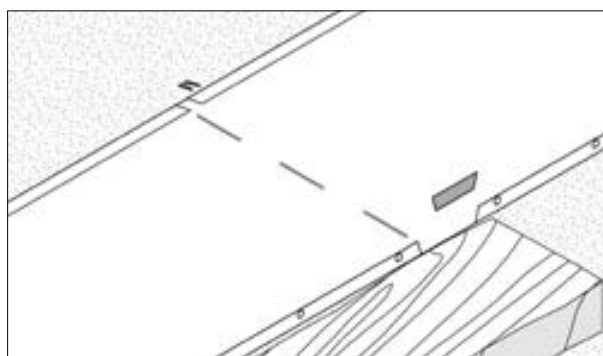

CURVE CAPABILITIES

In terms of curve capabilities, the 560mm Rigid Raised Garden Bed Panel barely curves. With care, you can achieve a 26m radius without distortion using this product.

Bracing methods

BRACING ON VARIOUS HARD SURFACES

The Universal Bracing Sets are best suited for these conditions. Simply fit the turnbuckle with cable or chain to the pre-fitted bracing ribs and anchor back to the ground. Alternatively, the 1100mm ground anchor sets can be used on hard surfaces that allow a post hole.

1. The stake that comes with the Universal Bracing Set is of a star picket style and will penetrate very hard surfaces, as do the fixing spikes that lock in the feet.
2. On concrete, a bolt down method can be used in place of the stake, anchoring the cable or chain with a DynaBolt™. Bolt the foot holes in place with an 8mm DynaBolt™, but first introduce packers to raise it slightly for drainage.

TIP : When using the Universal Bracing Sets, securing the anchor point to alternative structures such as walls or fences is also a workable solution.

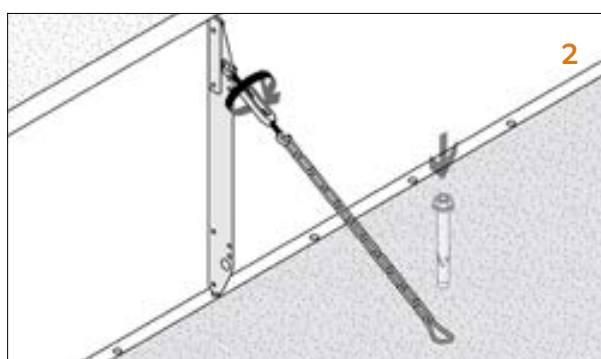
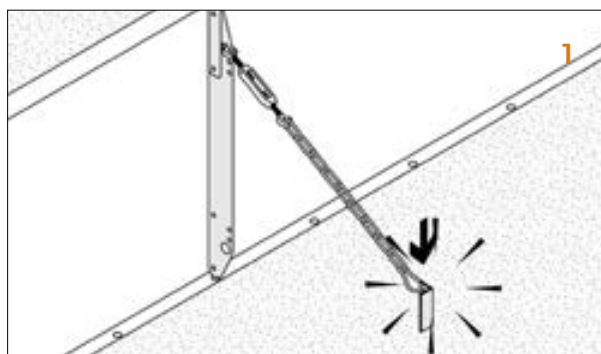

HOW TO MOVE A BRACING RIB

If bracing rib is located above an obstacle preventing staking at that position or where access is difficult it can be moved. Firstly, remove the bracing rib by knocking it laterally near the top with a hammer until loose. It can then be refitted in a new place, inserting the base portion into a bottom foot tab hole first, and then tapping the upper part of the bracing rib with a hammer to return it to a vertical position tight behind the top lip.

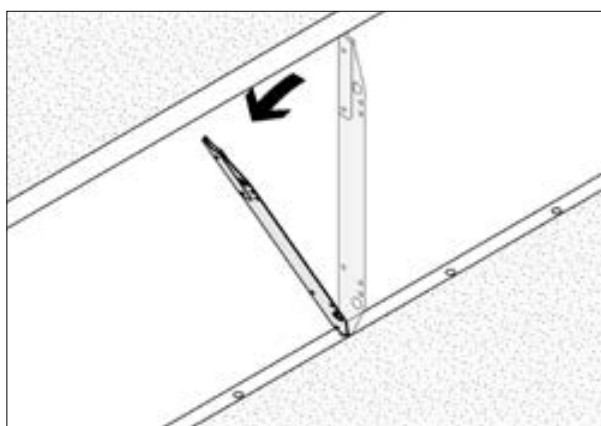

CREATING CONNECTION TABS OF YOUR OWN

The folded back flange on the end of a panel may be used to fix one end to a wall or other solid feature. Simply bolt or screw as appropriate to fix it strongly. When the edge panel is too long for this method you can use an angle grinder to make a fold back 'join tab' of your own. Remove the top lip portion, then create the fold back by the score and bend method. That tab can then be screwed internally to the surface it meets, which is sometimes another piece of Straightcurve®!

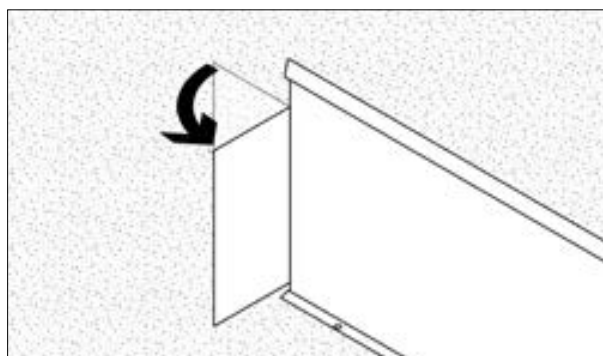
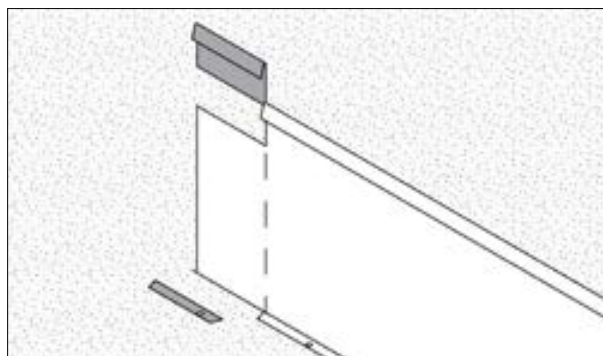

COMPATIBILITY AND WORKING ON SLOPES

1. The 560mm Rigid Raised Garden Bed Panel is compatible with the 560mm Flex Raised Garden Bed Panels. This allows them to work in combination. In fact, join slots align across all Rigid or Flex panels (240/400/560mm) so that a continuous top edge occurs if different heights are joined together.
2. This across height compatibility can be used to advantage with Raised Garden Beds on a slope. On the lower part of the slope the Raised Garden Bed run may need taller panels with a greater edge face visible due to the slope falling away, with panels of lesser height required further up the bank. It takes some careful planning, but can look very effective, adding volume and height to a bed while reducing the amount of steel used in the project overall.

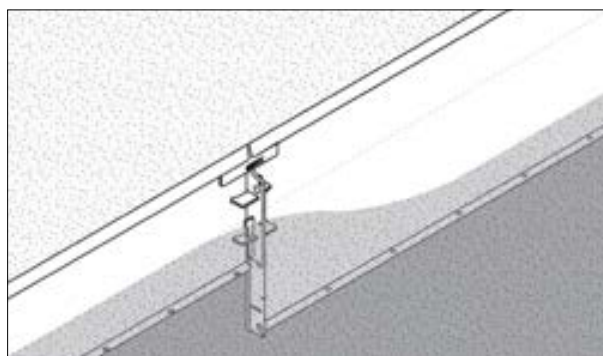
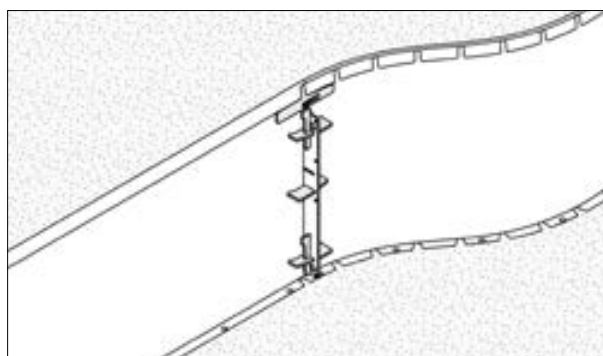

HOW TO USE A CUTBACK PANEL

If a length has been shortened with an angle grinder the join flange is then lost. To allow this piece to still be used the Join Part For Offcuts is simply screwed to the cutaway end (through guide holes in join part). This then overlays the length it is joining, and further screwing sees both panels neatly connected.

This overlay join part does mean screws are visible on the face of the Raised Garden Bed, but it is helpful with perimeters that require a part length to meet or when making regular shaped beds where the side length is predetermined. It also means no offcuts are wasted!

Some tips here are to either place the join part in the least conspicuous spot and use Zinc Screws which blend in as they rust over (for Weathering Steel), or make a feature of it by adding more join parts to create a pattern. With that approach, you may even choose to substitute polished bolt heads in place of the discreet screws.

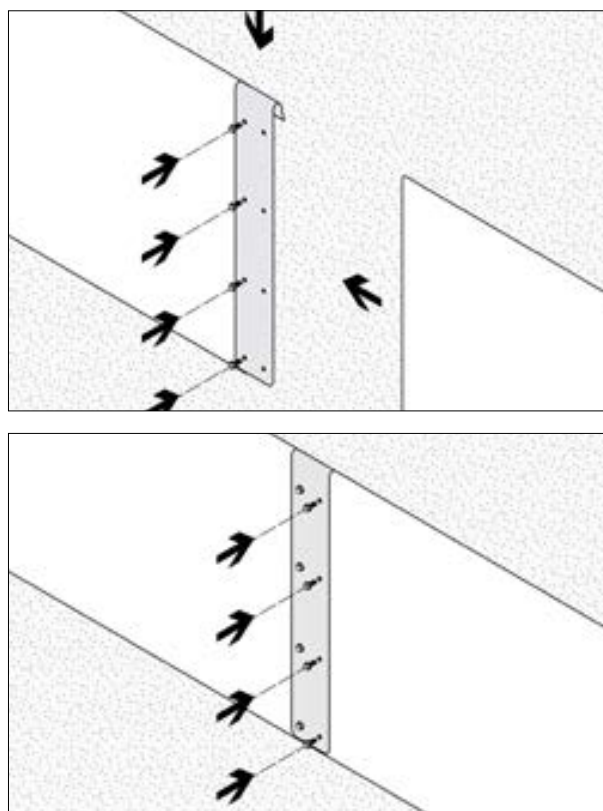

Straightcurve[®] Zero-Flex Raised Garden Bed Panel - 560mm

FHL560-400/600/800/1000/1200/2000WS WEATHERING STEEL
FHL560-400/600/800/1000/1200/2000GS GALVANISED STEEL

Product features

The details that make the difference



Option 1 (D): Universal bracing set with turnbuckle for fast, easier bracing; hooks into bracing rib.

Option 2 (D): Ground anchor set for alternative bracing method; fitting set joins post to panel at top and foot.

Full Face Above Ground instead of burying the edge.
Discreet Join Seams for a stylish finish.



Angular top profile and foot for Zero Flex performance
Round edge square tops for child & pet safety

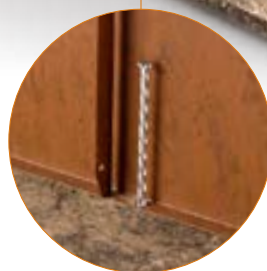

Moveable Fixing Spikes for easy obstacle avoidance



Precision engineered joint sets for fast, no weld method

EDGE STYLE



FINISHES

- Galvanised Steel
- Weathering Steel

For lasting, perfectly straight unmovable lines

Product specifications

TECHNICAL SPECIFICATIONS

Panel Lengths	400/600/800/1000/1200/2000 mm
Top edge thickness	46mm
Steel plate thickness	2mm
Weight per panel	3.5/5.0/6.6/8.2/9.7/15.8kg

BULK BUYING

Pack quantity	10
Bulk pack weight	35/50/66/80/97/158kg



JOIN SETS ARE REQUIRED

- A** Straight join set (panels in a line) *
- B** Closed corner set (standard 90°, right angle) *
- C** Reverse Corner set (270°, L-shapes) *

*All require Tek screws, select from above to suit configuration

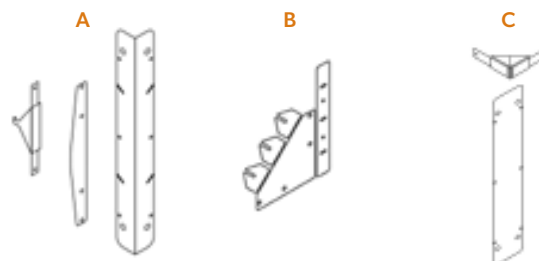

ADDITIONAL ACCESSORIES

REQUIRED

- D** UUniversal bracing set as ground anchor post alternative (turnbuckle/cable or chain/T-stake)
- E** Fixing spikes, galvanised, 300mm long
 - 2 for 400/600/800mm panels
 - 3 for 1000/1200/2000mm panels

OPTIONAL

- F** Ground anchor set - 1100mm, use one for every straight join/one extra for 2000mm panel midpoint
- G** Bracing Rib for 2000mm panels only (allows use of universal bracing set)
- H** Bracing strap set (used with opposing straight joins no wider than 1200mm apart only)

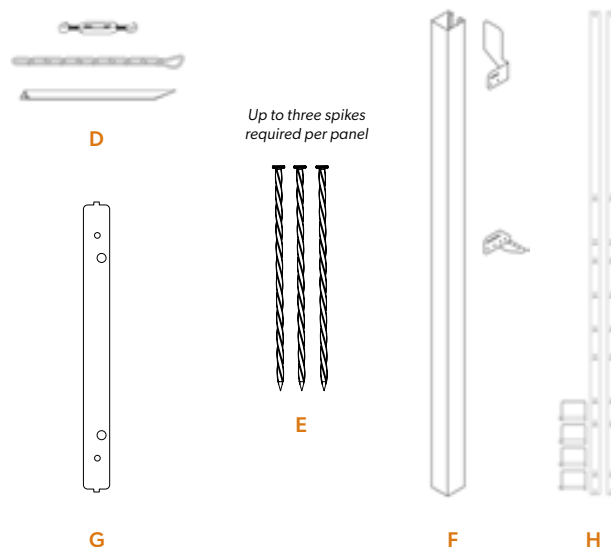

Up to three spikes required per panel

Creating XL planter box style raised garden beds

For Raised Garden Beds that look like really big planter boxes simply create your very own bespoke configurations using multiple Zero-Flex panels.

Cross bracing with the bracing strap set works when opposing straight joins are 1200mm or less apart. This means a free standing bed can be created with this internal bracing approach. The bracing strap set accommodates different widths up to 1200mm, and is simply snapped off for the correct span (repeatedly bend back and forth to snap point) and fitted between the available lock in holes.

For raised garden beds wider than 1200mm the cross bracing strap set is too short, so either a universal bracing set or a ground anchor set -1100mm (includes fitting set) can be used to brace each straight join.

L-shapes and U-shaped beds are also pretty easy once planned out, see how best to approach this below...



Choosing the right panels, join sets & accessories

In four easy steps

Step 1: Sketch out your raised garden bed shape including dimensions of all sides.

Step 2: Measure up - On your sketch, mark out all panel sizes required to build your design. Note: Straightcurve® planter panels are available in 400mm, 600mm, 800mm, 1000mm, 1200mm and 2000mm long lengths to make up a 'nearest to' option.

Step 3: Jot down the number of panels of each length needed for your design. Do the same for joining accessories (circle each panel join and tally the number of straight joins, closed corners, and reverse corners required)

Step 4: Brace it right - each straight join in your design will require bracing. Use one bracing strap set where two opposing joins are equal to or less than 1200mm apart. In all other situations, use one universal bracing set (or ground anchor post 1100mm + fitting set) per straight join. Make a note of how many of each type of bracing you need on your sketch.

Note: the join sets bring the panels snug together, but manufacturing tolerances mean what you get may be marginally longer than expected. Be careful with tight spaces!

*see what panel sizes are locally available or if lead times apply for any panel sizes, prior to planning.

We've sketched some examples for you →

Raised garden bed ideas...

MOST POPULAR

- Panels (1200) = 6
- Panels (600) = 2
- Closed Corners = 4
- Straight joins = 4
- Bracing Straps Set (BSS) = 2

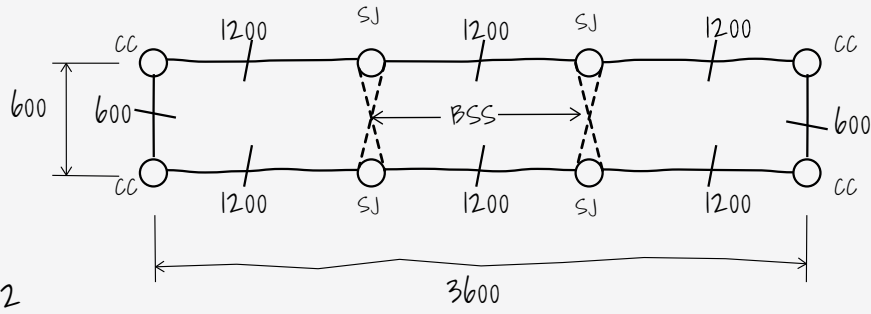

GET FUNKY

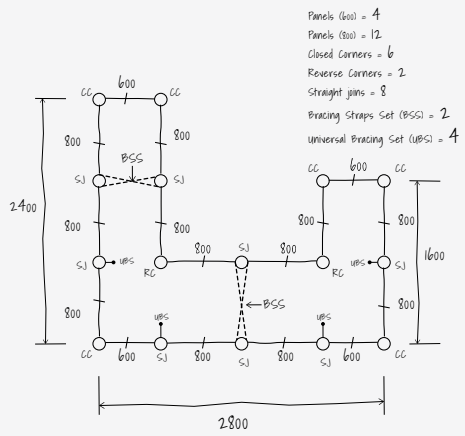
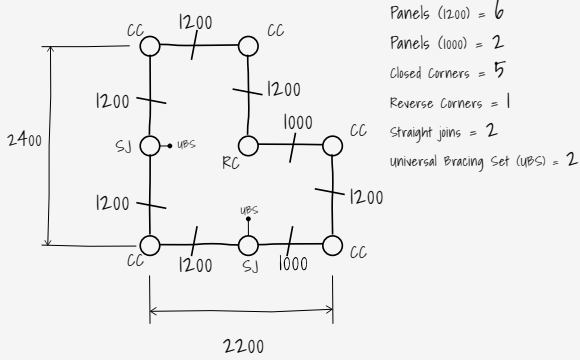

GREAT FOR CORNERS

- Panels (400) = 5
- Panels (800) = 3
- Panels (1200) = 1
- Closed Corners = 4
- Reverse Corners = 3
- Straight joins = 1
- Universal Bracing Set (UBS) = 1

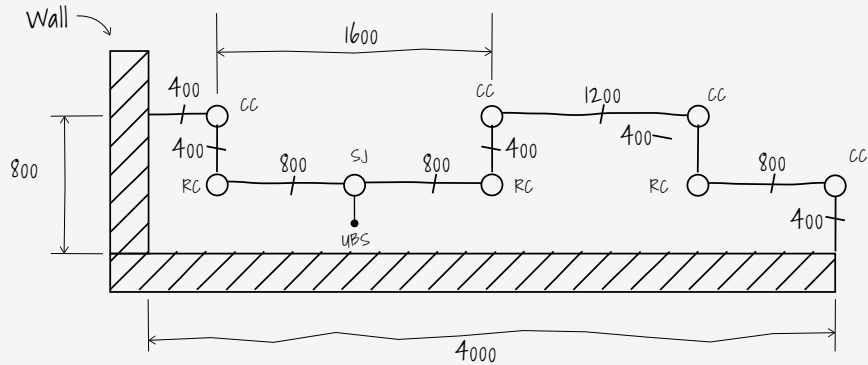

- Panels (600) = 12
- Closed Corners = 5
- Reverse Corners = 1
- Straight joins = 6
- Bracing Straps Set (BSS) = 2
- Universal Bracing Set (UBS) = 2

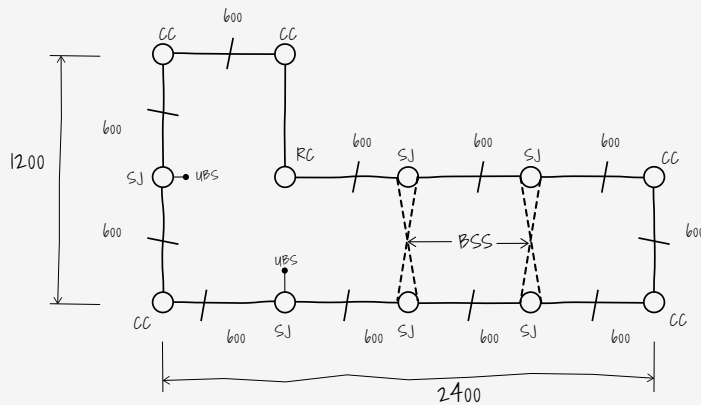

Zero-Flex Raised Garden Bed Panel - 560mm Installation Guide

REQUIRED FIXINGS

- Straight join set
10 x Tek Screws (12G x 16mm)
- Closed corner set
6 x Tek Screws (12G x 16mm)
- Reverse corner set
8 x Tek Screws (12G x 16mm)
- Ground anchor set -1100mm
6 x Tek Screws (12G x 16mm)

RECOMMENDED TOOLS

- Ground leveling tools
- Metal hammer
- Cordless drill and Tek screw bit
- Pliers

PREPARATIONS

The Zero-Flex Raised Garden Bed requires NO digging in as it is fixed at the feet to the ground surface. The ground should be level for the edge to sit flush on during installation. Any obstructions should be removed or re-routed. It can be installed on all level ground types including concrete surfaces (where packers are used to sit edge off ground to allow drainage).

DO...

- ✔ Check the line with a string line before fixing the base.
- ✔ Use join set parts in the stepped order recommended
- ✔ Get the top join pieces to sit just right before screwing tight
- ✔ Brace near to or at all straight joins
- ✔ If installing on a hard surface line the bed to prevent grit spillage
- ✔ Set drill speed to high when drilling into ground anchor posts

DON'T...

- ✘ Set directly onto a hard surface without raising slightly with packers for drainage
- ✘ Forget to stake/brace any straight joins or ends
- ✘ Accelerate rust with acids or salts (but soapy water is ok!)
- ✘ Try and use pop rivets, requires Tek screws for strength
- ✘ Forget the safety gloves when working with steel!

MARKING OUT AND SECURING ASSEMBLED GARDEN BEDS

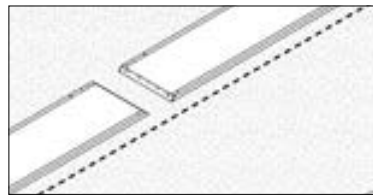

MARKING SHAPE - Mark edge line or use string line on flat ground and layout edge pieces nearby. All panels will now require joining by way of joining option A, B or C.

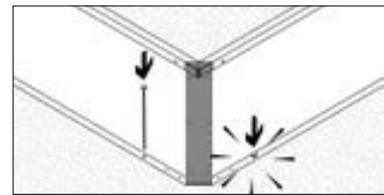

SECURING TO GROUND - Once ALL the panels are joined and in the exact finishing position use fixing spikes to secure base through holes in foot.

STAKING / BRACING FOR SUPPORT - Will be required and two methods are explained in following pages.

BACKFILL - Evenly to complete the project once staking/bracing is done.

(A) STRAIGHT JOIN

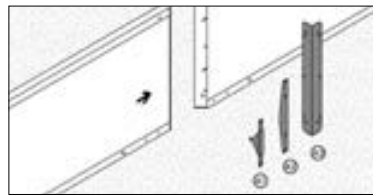

STEP 1 - For a straight join (two panels in a line) use the Straight Join Set (A). Separate the pieces in the set.

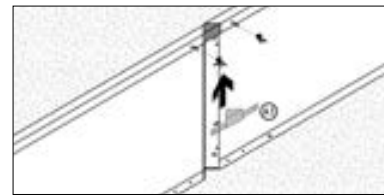

STEP 2 - Stand the first two panels together on a flat surface and insert top connector piece (A1), align guide holes and screw.

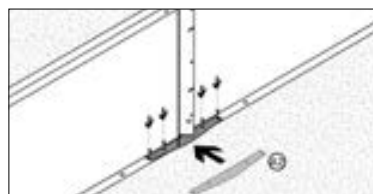

STEP 3 - Slide in foot joiner (A2), align guide holes and screw.

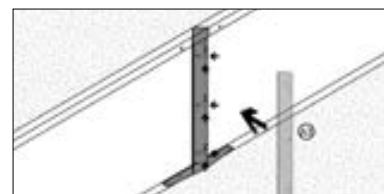

STEP 4 - Fit back rib (A3) flush to align guide holes and screw.

Scan or click to watch install video

▶ INSTALL GUIDE



75mm

100mm

150mm

240mm

400mm

560mm

Planter boxes

(B) RIGHT ANGLE CORNER (90°)

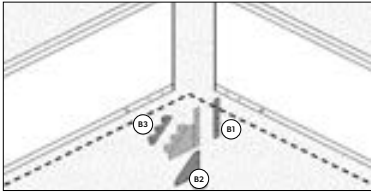

STEP 1 - When creating a standard right angle corner (90°) use the Corner Join Set (B). Break apart the pieces in the set.

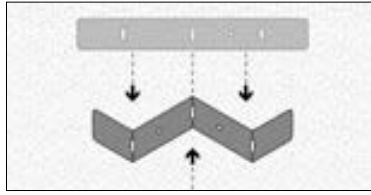

STEP 2 - Take strip piece (B1) and use pliers to shape into staircase pattern.

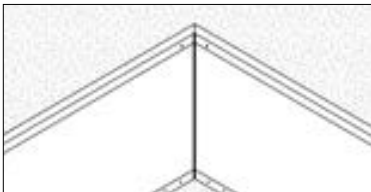

STEP 3 - Stand the two panels at right angles to each other and butt together.

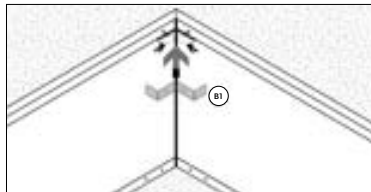

STEP 4 - To join - insert top connector 'staircase' piece (B1), align guide holes and screw.

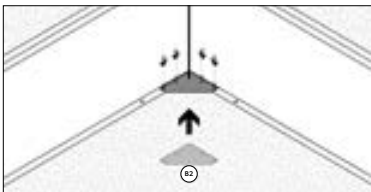

STEP 5 - Slide in foot joiner (B2), align guide holes and screw.

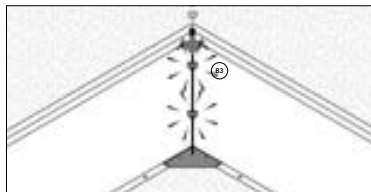

STEP 6 - Firmly grip and hammer arrow shaped wedge pieces (B3) into angled slots at back to fully secure the join.

(C) REVERSE CORNER (L SHAPE BED)

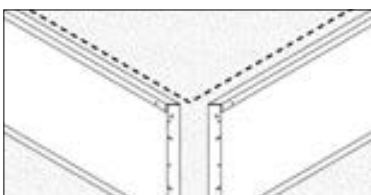

STEP 1 - For a reverse corner stand the two panels in the L shape formation and butt them together.

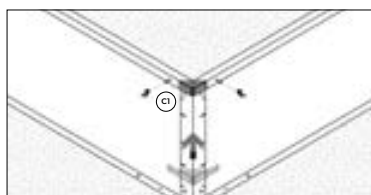

STEP 2 - From the reverse corner join set (C), insert (slide in) the top piece (C1) as shown and align guide holes and Tek screw in place.

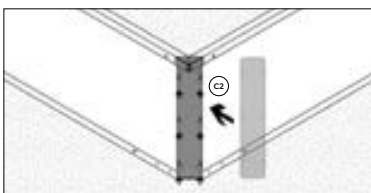

STEP 3 - Position the back fixing plate (C2) align and Tek screw through guide holes to secure.

BRACING THE PANELS

ALL straight joins and garden bed ends will require bracing.
Either:

1. Use Universal Bracing Set to hook into top hole in join rib and anchor to the ground, adjusting tension with the turnbuckle. For the middle of the 2000mm panels there is no such point of attachment, but bracing is needed. In this case, insert the bracing rib for 2000mm panels in the middle of the panel and attach the universal bracing set to this fitted bracing rib
OR
2. Use Grounding Anchor Set -1100mm adjacent straight joins and at wall ends (also an alternative method to brace middle of 2000mm length panels). Fitting set is used to attach post to bottom foot and behind top fold of the panel.

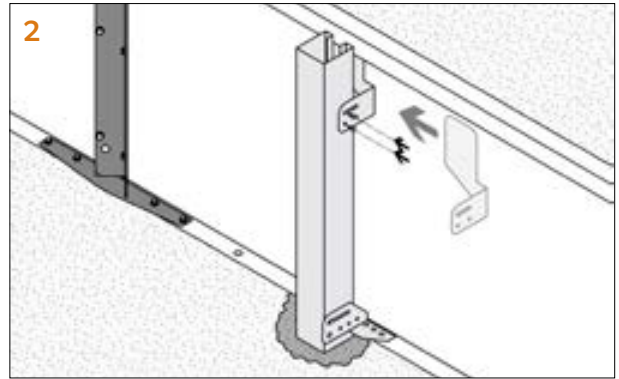
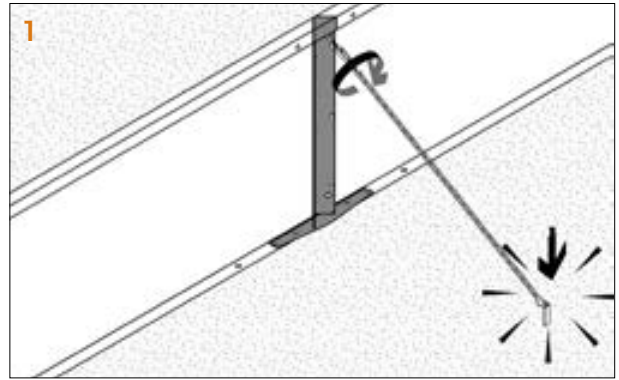

75mm

100mm

150mm

240mm

400mm

560mm

Planter boxes

HARD SURFACE BRACING & USING BRACING STRAPS

In these situations use the Universal Bracing Sets. Fit the turnbuckle with cable or chain to the straight joins through hook-in holes and anchor with the stake supplied.

1. The stake that comes with the Universal Bracing Set is of a star picket style and will penetrate very hard surfaces, as do the fixing spikes that lock in the feet.
2. On concrete, a bolt-down method can be used in place of the stake, anchoring the cable or chain with a DynaBolt™ (A). Bolt the foot holes in place with an 8mm DynaBolt™ (B), but first introduce packers to raise it slightly for drainage.
3. If you can't penetrate the surface at all you can create a free standing Raised Garden Bed or use our four panel planter boxes that require no lock down. For free standing raised garden beds with straight joins that are no wider than 1200mm, opposing straight joins can be braced with our cross bracing straps running between them. These are simply attached as crossover diagonal straps that run from the top of both straight joins to the bottom of the opposite straight join. Note that the bracing strap only works between two straight joins, so when a straight join is opposite a reverse corner (as in an L-shape design) the universal bracing set is required for that straight join.

TIP: When using the Universal Bracing Sets, securing the anchor point to alternative structures such as walls or fences is also a workable solution. Use more rather than less chain length when the install space allows this.

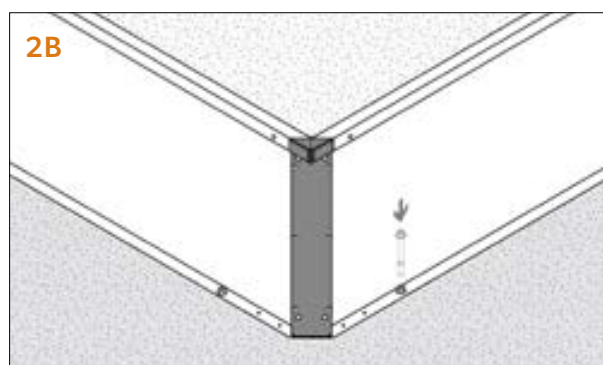
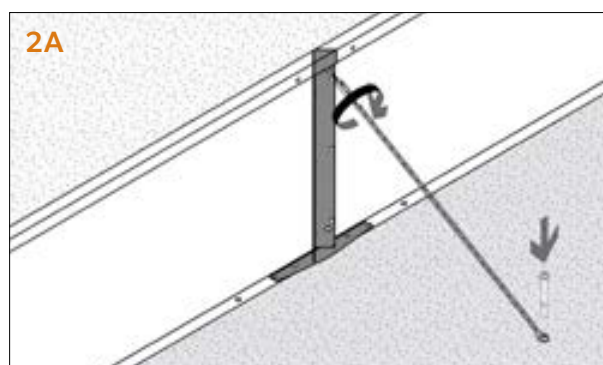
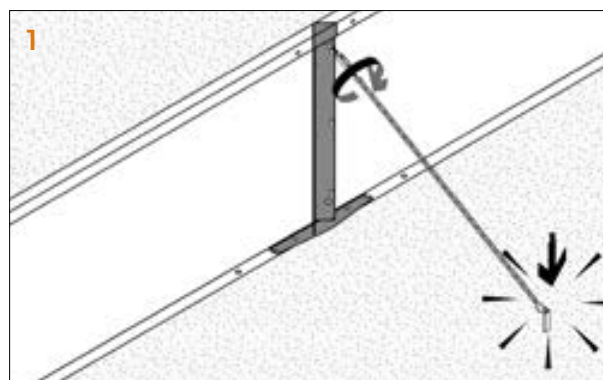

MAKING DIFFERENT HEIGHT RAISED GARDEN BEDS

The Zero-Flex raised garden beds look great in combination, with different heights placed together. They are not join compatible between heights, so the way to do this is to build them as separate raised garden beds and then butt them together or position them in proximity. A perfectly level base would be key to achieving this look.

SPECIAL CASE - USING A 2000MM PANEL

These panels are the longest available and will require a ground anchor set at the midpoint as well as where straight joins occur. If using the Universal Bracing Set at the panel midpoint, the dedicated bracing rib needs to be purchased to allow attachment of the turnbuckle.

Technical Drawings

75mm

100mm

150mm

240mm

400mm

560mm

Planter boxes

STRAIGHTCURVE® FLEX RAISED GARDEN BED PANEL - 560MM

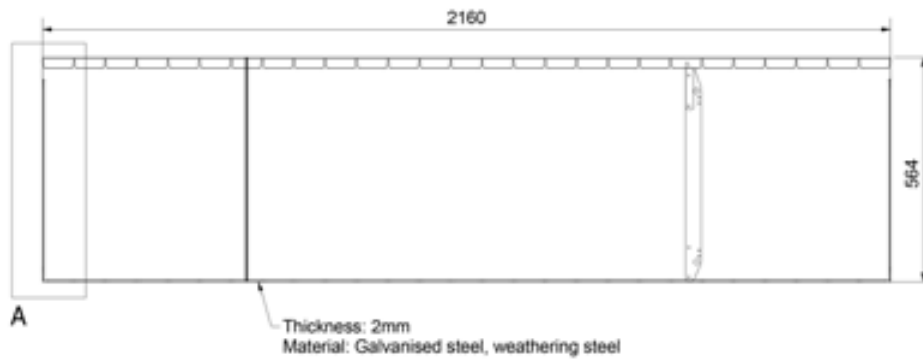

STRAIGHTCURVE® RIGID RAISED GARDEN BED PANEL - 560mm



UNIVERSAL SPECIFICATIONS

SIDE PROFILE/JOIN FLANGE

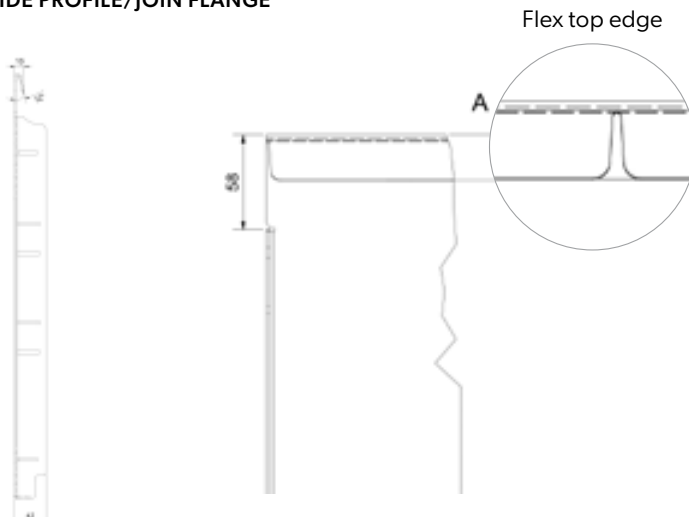



75mm

100mm

150mm

240mm

400mm

560mm

Planter boxes

STRAIGHTCURVE® ZERO-FLEX RAISED GARDEN BED PANEL - 560MM

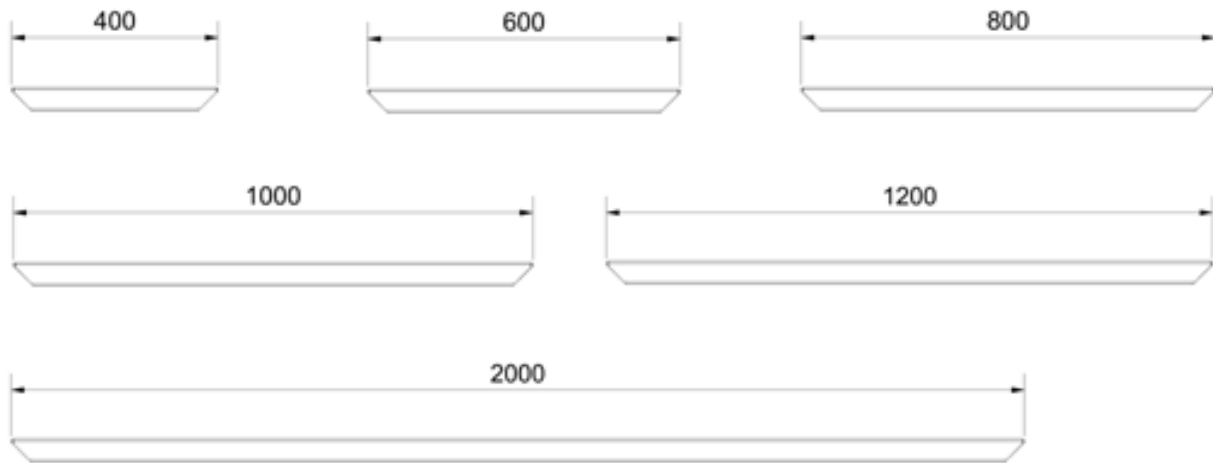

PANEL END/JOIN FLANGE

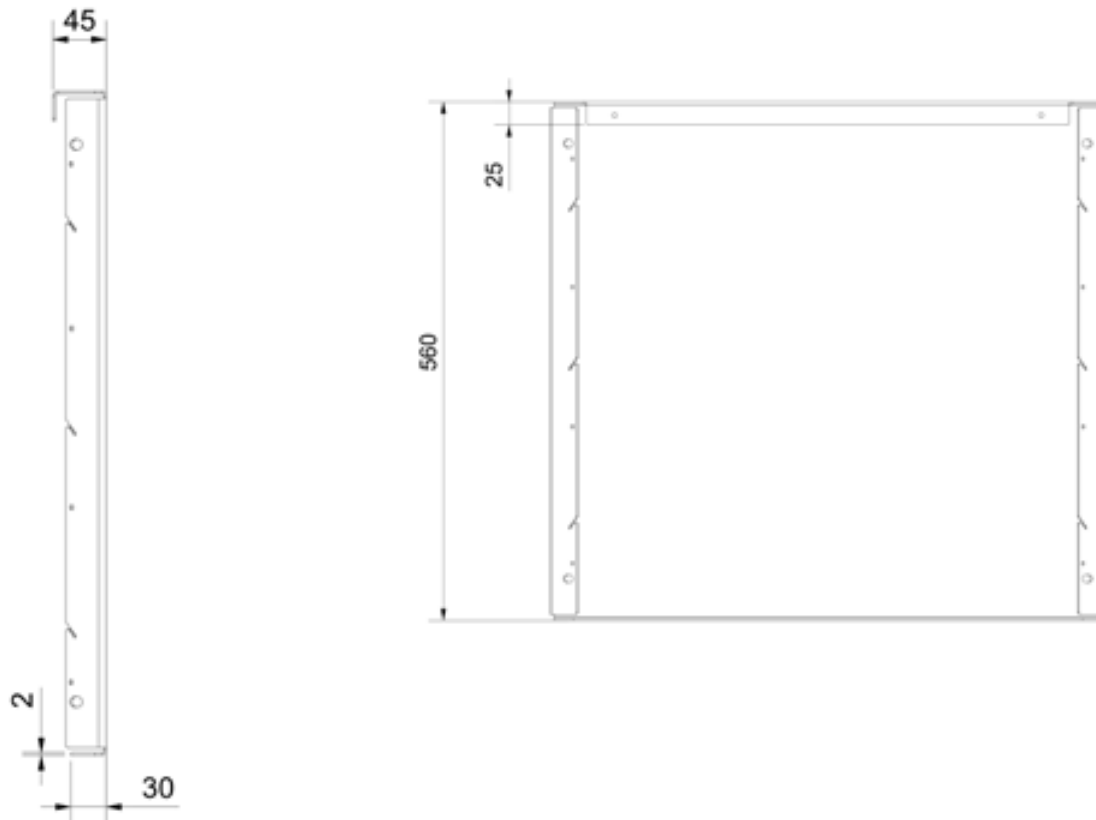

NOTE: Foot holes not shown in these diagrams are of 9mm diameter

400 & 560mm Planter Boxes

For sturdy, long lasting, precision engineered planter boxes to fit any space

Do you know what size and shape planter box you need for your project? Let's make this decision easier for you here!

Our planter boxes can be...



OR



OR



SQUARE

RECTANGULAR

CUSTOM DESIGN



Going big, or like a custom shape? Simply sketch a plan and order ...

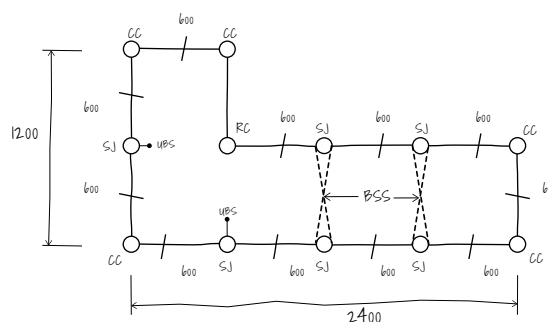
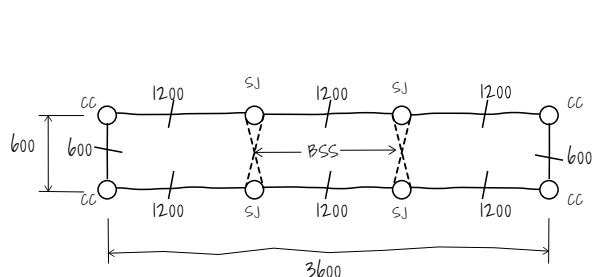

... while choosing from our 400mm or 560mm tall options

How to choose between the 400mm and 560mm planter box?

This choice is all about look and use and thinking ahead. A planter box can improve accessibility and offer protection for the plants it contains; and the 400mm may be tall enough to achieve that. It can also stand out and add presence, so if you're seeking something eye catching the 560mm may be your best choice. If it's nestled within a garden, plant to complement the planter box and consider how high any surrounding plants will grow. A planter box can also bring plants closer to your living spaces, in which case, any height will do, just pick your favourite!

Our planter boxes come with a few benefits worth noting...

Something I can do myself with no need for professional help



A super high-quality planter box that's stylish and strong



Different size and configuration choices so I can order one to fit my space beautifully



Remove the stress and cost of transporting premade planters - they come flatpacked



Easier access to difficult sites, just walk in the panels



A Planter box with precision engineered join seams - no welding marks or visible bolts



Something with a square shaped top edge making it appear boxy while adding strength



A planter box with smooth rounded edges for safety and enhanced ergonomics



A planter box with secure lockdown capabilities



How about this!? You might choose to position different height planter boxes near to each other for added design interest!

Product overview

ROUNDED TOPS AND SAFETY FEATURES

The smooth, rounded tops and edges assist safe handling. When installed, all joins/fixings are internal so that the exposed top and front present as a smooth top edge and continuous fascia.

SAFER AND CLEANER HANDLING

We recommend wearing gloves as the manufacturing process can leave residual oils/dust and our products can get hot when exposed to sunlight. Our products are shipped in bundles, when lifting bundles handlers should be mindful of their carrying capabilities. Single items are easy to carry for one person (see product weights).

ABOUT WEATHERING STEEL

The manufacturing process of weathering steel leaves the surface in a dark, almost black state. This dark 'finish' is an oxide layer that forms during the hot rolling process. The weathering process needs to break this layer down first before the desired protective patina layer can be established. You can expect some inconsistency in the patina formation because the thickness of the oxide layer varies; it'll appear spotty with some areas going orange and others still black.

The patina develops naturally with periods of wet and dry, and both phases are key for its steady formation. Do not wet continually without allowing time for thorough drying. A faster patina formation can be aided by cleaning the surface with soapy water to remove oil residue, but anything harsher is not advised as it can be detrimental to patina development and consequently, reduce product lifespan. Some rust solution products are safe to use as these 'build a surface patina' rather than just accelerating rusting.

WHAT IS A PATINA

Patina is not the same as rust. All rust is patina, but not all patina is rust. Patina is a chemical bond between various elements and usually oxygen. It can be found on most metals with the exception of 8 inert (noble) metals like gold or silver. 'Normal' rust is iron-oxide, the patina referred to above is mostly a bond between copper, phosphorus, chromium, nickel, iron and oxygen. You may wonder, how does water feature in it? Water acts as an electrolyte, but

that's a different story. In the end, the patina formed on weathering steel is a dense layer that doesn't flake or allow oxygen through. Therefore, once formed, the oxidation process slows down dramatically.

WILL THE STEEL STAIN MY PAVERS OR DECK?

This can occur in the early stages of rusting but can be avoided with care, such as by protecting nearby surfaces while the patina establishes. The worst cases of this you will see involves mild steel because the rusting carries on unabated. With weathering steel this should only happen when first developing a patina or if rushed artificially (sped up with acids/salts) to achieve faster colour change. What you can do as an excellent strategy is pre-rust the edging before installing to have a stable early phase patina there already. This doesn't need to take long if you procure a rust solution recommended for steady patina formation.

LONGEVITY

Our products are of the highest quality ensuring longevity in the given environment. For further information please refer to the "Longevity Guide" and "Product Care Guide" on our website.

PAINTING, SEALING AND POWDERCOATING

Our galvanised products are suited to painting, but the surface should be thoroughly prepared (using acetone wash), and sealed with a metal primer (etch primer is very good) to maximise topcoat adhesion.

Powdercoating is a much more durable/hardy choice, and can be requested for large projects with lead times/costings supplied. It is worth noting that not all powdercoating performs the same, we use and recommend Interpon powder from AkzoNobel for assured quality and maximum endurance and suggest you request the same. It's also worth asking first to see a sample from your chosen powdercoater specialist. Note that, as for painting, galvanised products should be used whenever powdercoating.

Another question we get relates to freezing the colour (or patina development) at a certain stage. That's possible using a transparent sealant suitable for steel. Keep in mind that the colour will change when applying a sealant, it'll get a 'wet' look. Be sure to test this in a small inconspicuous area first before fully committing. This will require reapplication once a year.

CAN I LOCKDOWN THE PLANTER BOX TO THE GROUND?

You may choose to lockdown the planter in it's final position. The foot has 9mm holes in it to allow use of fixing spikes (for penetrable ground) or bolts when on a hard surface. In that latter case, ensure adequate drainage (packers are one option) to be sure the planter is not left sitting in pooled water at anytime.

For custom design beds where straight joins require support with a brace, then concreting the anchor post may be necessary to support the join and simultaneously lockdown the planter.

A filled planter box is going to be very stable and difficult to remove though, so in most cases locking down the planter box is not required.

WHY DO WE SUPPLY AND RECOMMEND TEK SCREWS?

Tek screws are great for their self-tapping (self-drilling) abilities and the inherent strength this gives to the planter box joins. They provide an easy, fast and strong method for joining when combined with our pre-drilled guide holes . The long lasting, grey Dacromet Tek screws are best for all the buried screw locations of these products.

ADVANTAGES

- ✓ Smooth rounded edges for safety and feel
- ✓ Up to 3x faster installation
- ✓ No welding required
- ✓ Flatpack approach means more deliverable possibilities
- ✓ No Experience/training needed
- ✓ Designed for ease of use

75mm

100mm

150mm

240mm

400mm

560mm

Planter boxes

Straightcurve® Planter Box / 4-Panel Kits & Custom Panel Orders - 400mm

Made from selection of panel sizes (OR from pre made kits as sets of 4 panels with parts incl.)

FHL400-400/600/800/1000/1200WS WEATHERING STEEL

FHL400-400/600/800/1000/1200GS GALVANISED STEEL

Product features

The details that make the difference

Precision Engineered Join System
for designer seams



KNOW THE SIZE YOU NEED?

Select the right Square or Rectangle planter box kit OR choose the right size panels yourself for a four panel square or rectangle planter box.

The kits will include the 4 corner sets required. If purchasing panels separately be sure to order the four corner join sets too.



Round edge square tops with folded down inside edge for child & pet safety



Hidden fixings and whole panel sides for clean finish



Boxy top profile for both great looks and strength

75mm

100mm

150mm

240mm

400mm

560mm

Planter boxes

EDGE STYLE



FINISHES

- Galvanised Steel
- Weathering Steel

For lasting, sturdy planter boxes that look both bold and beautiful

Product specifications

TECHNICAL SPECIFICATIONS (for BOTH kits and custom planters)

Panel Lengths	400/600/800/1000/1200 mm (use set of 4 or 2+2 for 4-panel planter boxes)
Top edge thickness	46mm
Steel plate thickness	2mm
Weight per panel	3.5/5.0/6.6/8.2/9.7/15.8kg (multiply for kit weights)
BULK BUYING	
Pack quantity	10
Bulk pack weight	35/50/66/80/97/158kg



JOIN SETS ARE REQUIRED

- A** A Straight join set (for longer custom planters)*
- B** Closed corner set (standard 90°, right angle)*
4 supplied in premade kits
- B** Reverse Corner set (270°, L-shapes)*

*All require Tek screws, select from above to suit planter box design

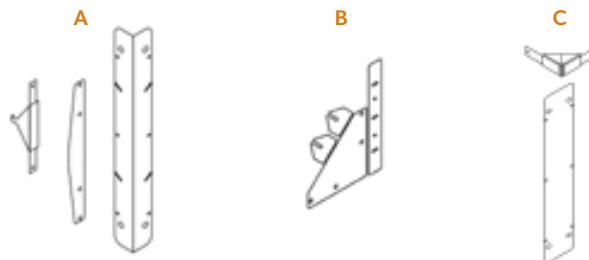

ADDITIONAL ACCESSORIES

OPTIONAL

If lockdown required :

- B** Fixing spikes, galvanised, 300mm long
 - 2 for 400/600/800mm panels
 - 3 for 1000/1200 panels

Up to three spikes required per panel



B

Planter Box 4-Panel Kit & Custom Easy-Build Planter Boxes - 400mm Installation Guide

Scan or click to watch install video



RECOMMENDED TOOLS

- Ground leveling tools
- Metal hammer
- Cordless drill and Tek screw bit
- Pliers

PREPARATIONS

Construct the bed on a clean, even area free from grit and debris. Also have the install space level and clear for install once you have made the planter box.

It can be installed on all level ground types including concrete surfaces (where packers are used to sit edge off ground to allow drainage).

Note that the corner join base part can be screwed on from underneath to avoid the screws scratching the surface for sensitive installs such as decks or paving. This planter is bottomless, so consider how you may line the planter in such situations too.

DO...

- ✔ Use corner join set parts in the stepped order recommended
- ✔ Get the top join pieces to sit just right before screwing tight
- ✔ If installing on a hard surface line the bed to prevent grit spillage
- ✔ Set drill speed to high when drilling Tek screws

DON'T...

- ✘ Set directly onto a hard surface without raising slightly with packers for drainage
- ✘ Accelerate rust with acids or salts (but soapy water is ok!)
- ✘ Try and use pop rivets, requires Tek screws for strength
- ✘ Forget the safety gloves when working with steel!

MAKING A 4 PANEL SQUARE / RECTANGULAR PLANTER BOX

JOIN PANELS TOGETHER

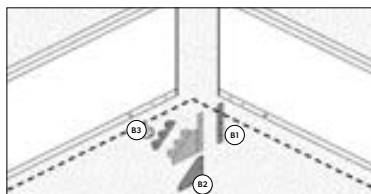

STEP 1 - Use the Corner Join Set (B). Break apart the pieces in the set.

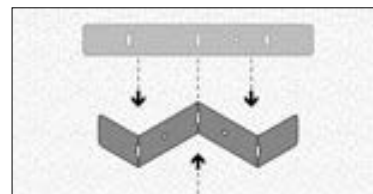

STEP 2 - Take strip piece (B1) and use pliers to shape into staircase pattern.

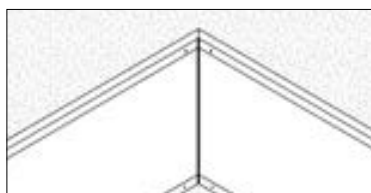

STEP 3 - Stand the two panels at right angles to each other and butt together.

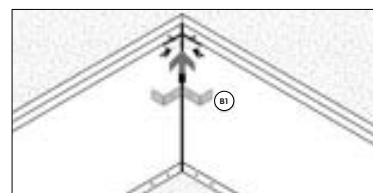

STEP 4 - To join insert top connector 'staircase' piece (B1), align guide holes and screw.

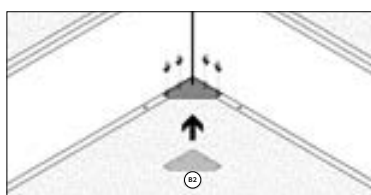

STEP 5 - Slide in foot joiner (B2), align guide holes and screw. (NB screw from below if installing on a hard surface)

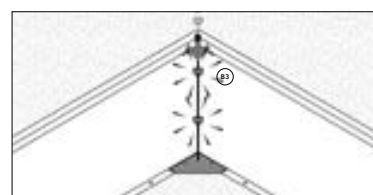

STEP 6 - Firmly grip and hammer arrow shaped wedge pieces (B3) into angled slots at back to fully secure the join.

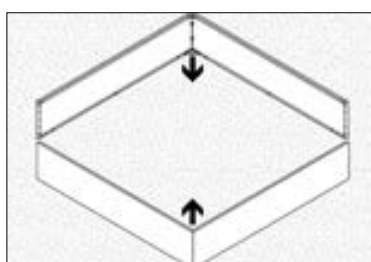

STEP 7 - Repeat above for other pair of panels and then bring them all together

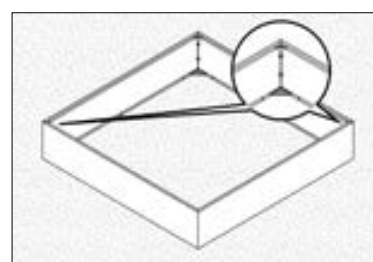

STEP 8 - Complete the last two corner joins

SECURING TO GROUND (OPTIONAL) - If you choose to do this use fixing spikes to secure base through holes in foot. Order these separately if needed.

BACKFILL - evenly to complete, lining the bed first with something like geofabric if necessary

75mm

100mm

150mm

240mm

400mm

560mm

Planter boxes

Custom Easy-Build Planter Boxes

In four easy steps

Step 1: Sketch out your raised garden bed shape including dimensions of all sides.

Step 2: Measure up - On your sketch, mark out all panel sizes required to build your design. Note: Straightcurve® planter panels are available in 400mm, 600mm, 800mm, 1000mm, 1200mm and 2000mm long lengths to make up a 'nearest to' option.

Step 3: Jot down the number of panels of each length needed for your design. Do the same for joining accessories (circle each panel join and tally the number of straight joins, closed corners, and reverse corners required)

Step 4: Brace it right - each straight join in your design will require bracing. Use one bracing strap set where two opposing joins are equal to or less than 1200mm apart. In all other situations, use one universal bracing set (or ground anchor post 1100mm + fitting set) per straight join. Make a note of how many of each type of bracing you need on your sketch.

MOST POPULAR

Panels (1200) = 6
 Panels (600) = 2
 Closed Corners = 4
 Straight joins = 4
 Bracing Straps Set (BSS) = 2

Panels (600) = 12
 Closed Corners = 5
 Reverse Corners = 1
 Straight joins = 6
 Bracing Straps Set (BSS) = 2
 Universal Bracing Set (UBS) = 2

Panels (600) = 4
 Panels (800) = 12
 Closed Corners = 6
 Reverse Corners = 2
 Straight joins = 8
 Bracing Straps Set (BSS) = 2
 Universal Bracing Set (UBS) = 4

GET FUNKY

Panels (1200) = 6
 Panels (1000) = 2
 Closed Corners = 5
 Reverse Corners = 1
 Straight joins = 2
 Universal Bracing Set (UBS) = 2

GREAT FOR CORNERS

Panels (400) = 5
 Panels (800) = 3
 Panels (1200) = 1
 Closed Corners = 4
 Reverse Corners = 3
 Straight joins = 1
 Universal Bracing Set (UBS) = 1

MAKING A CUSTOM EASY-BUILD PLANTER BOX

NOTE: ALL PANELS REQUIRE JOINING

Scan or click to watch install video



1. REFER TO MAKING A 4 PANEL SQUARE / RECTANGULAR PLANTER BOXES TO SEE THE CLOSED CORNER JOIN.

2. STRAIGHT JOINS ARE DONE LIKE SO:

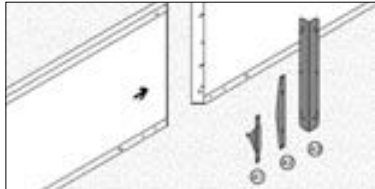

STEP 1 - For a straight join (two panels in a line) use the Straight Join Set (A). Separate the pieces in the set.

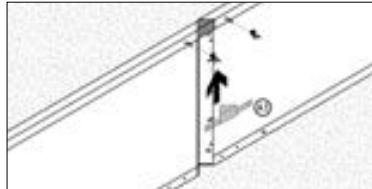

STEP 2 - Stand the first two panels together on a flat surface and insert top connector piece (A1), align guide holes and screw.

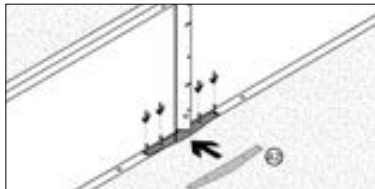

STEP 3 - Slide in foot joiner (A2), align guide holes and screw.

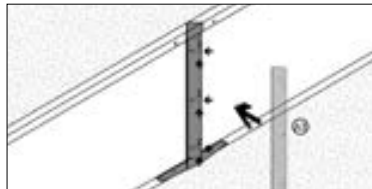

STEP 4 - Fit back rib (A3) flush to align guide holes and screw.

3. REVERSE CORNERS ARE DONE LIKE SO:

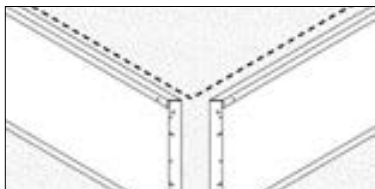

STEP 1 - For a reverse corner stand the two panels in the L shape formation and butt them together.

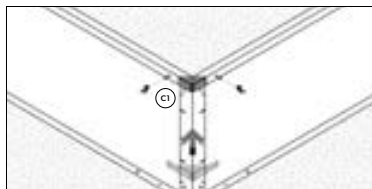

STEP 2 - From the reverse corner join set (C), insert (slide in) the top piece (C1) as shown and align guide holes and Tek screw in place.

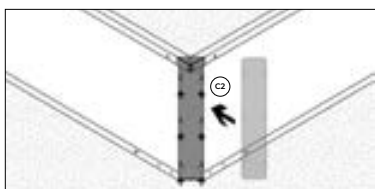

STEP 3 - Position the back fixing plate (C2) align and Tek screw through guide holes to secure.

75mm

100mm

150mm

240mm

400mm

560mm

Planter boxes

BRACING REQUIRED FOR STRAIGHT JOINS

YOU HAVE THREE OPTIONS:

A. WHERE TWO OPPOSING JOINS ARE LESS THAN 1200MM APART

- BRACING STRAP SET:** One Bracing strap set (two lengths) will span as a cross brace between the two joins as shown. The braces run diagonally from the top of both straight joins to the bottom of the opposite straight joins. These are designed to cater for different spans, simply breakaway to required span by hand, by bending back and forth, then attach with lock pins supplied.

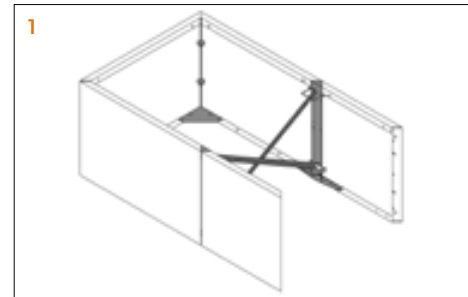

B. FOR STRAIGHT JOINS GREATER THAN 1200MM APART - if not directly opposite another straight join use either:

- UNIVERSAL BRACING SET:** The universal Bracing set will hook into top hole in join rib and anchor to the ground. Adjust final tension with the turnbuckle. This is real easy.
- THE GROUND ANCHOR SET - 1100MM:** Installed near to the straight join, installing the post first then using the fitting set to screw and secure panel to the post. This involves a little digging!

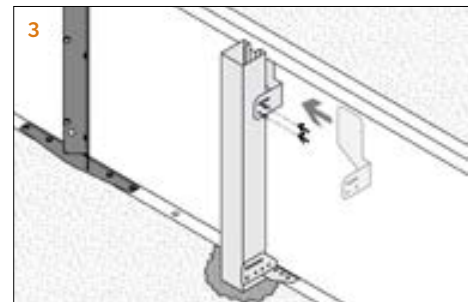
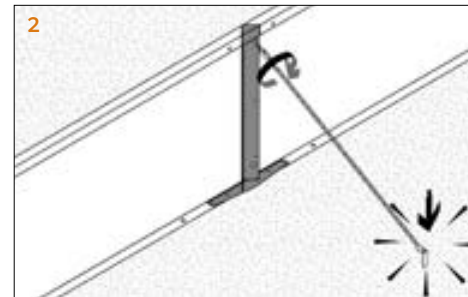

MAKING DIFFERENT HEIGHT PLANTER BOXES

The Planter Boxes will look great in combination, with different heights placed together. Note that our Zero-Flex Raised Garden Bed 240mm product has the same profile/look, if you'd like to add that height to the mix! Setting all planters perfectly level is key to achieving this look.

SPECIAL CASE - USING A 2000MM PANEL

These panels are not listed here but can be found in the Zero-Flex Raised Garden Beds product pages. Investigate there if you want to build an XL four panel planter and note the bracing requirements for that size.

Straightcurve® Planter Box / 4-Panel Kits & Custom Panel Orders - 560mm

Made from selection of panel sizes (OR from pre made kits as sets of 4 panels with parts incl.)

FHL560-400/600/800/1000/1200WS WEATHERING STEEL

FHL560-400/600/800/1000/1200GS GALVANISED STEEL

Product features

The details that make the difference

KNOW THE SIZE YOU NEED?

Select the right Square or Rectangle planter box kit OR choose the right size panels yourself for a four panel square or rectangle planter box.

The kits will include the 4 corner sets required. If purchasing panels separately be sure to order the four corner join sets too.

For an even more custom approach, read on!

Boxy top profile for both great looks and strength



Round edge square tops with folded down inside edge for child & pet safety



Hidden fixings and whole panel sides for clean finish





Precision Engineered Join System for designer seams

EDGE STYLE



FINISHES

-  Galvanised Steel
-  Weathering Steel

For lasting, sturdy planter boxes that look both bold and beautiful

Product specifications

TECHNICAL SPECIFICATIONS (for BOTH kits and custom planters)

Panel Lengths	400/600/800/1000/1200 mm (use set of 4 or 2+2 for 4-panel planter boxes)
Top edge thickness	46mm
Steel plate thickness	2mm
Weight per panel	3.5/5.0/6.6/8.2/9.7/15.8kg (multiply for kit weights)
BULK BUYING	
Pack quantity	10
Bulk pack weight	35/50/66/80/97/158kg



JOIN SETS ARE REQUIRED

- A** A Straight join set (for longer custom planters)*
- B** Closed corner set (standard 90°, right angle)*
4 supplied in premade kits
- B** Reverse Corner set (270°, L-shapes)*

*All require Tek screws, select from above to suit planter box design

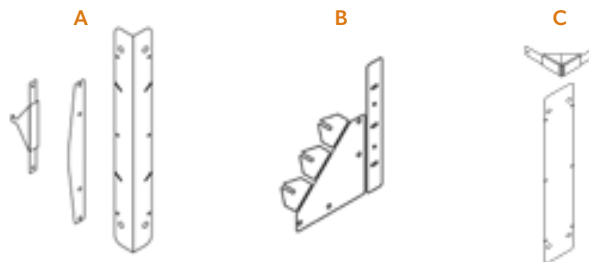

ADDITIONAL ACCESSORIES

OPTIONAL

If lockdown required :

- B** Fixing spikes, galvanised, 300mm long
 - 2 for 400/600/800mm panels
 - 3 for 1000/1200mm panels

Up to three spikes required per panel



B

Planter Box 4-Panel Kit & Custom Easy-Build Planter Boxes - 560mm Installation Guide

Scan or click to watch install video



RECOMMENDED TOOLS

- Ground leveling tools
- Metal hammer
- Cordless drill and Tek screw bit
- Pliers

PREPARATIONS

Construct the bed on a clean, even area free from grit and debris. Also have the install space level and clear for install once you have made the planter box.

It can be installed on all level ground types including concrete surfaces (where packers are used to sit edge off ground to allow drainage).

Note that the corner join base part can be screwed on from underneath to avoid the screws scratching the surface for sensitive installs such as decks or paving. This planter is bottomless, so consider how you may line the planter in such situations too.

DO...

- ✔ Use corner join set parts in the stepped order recommended
- ✔ Get the top join pieces to sit just right before screwing tight
- ✔ If installing on a hard surface line the bed to prevent grit spillage
- ✔ Set drill speed to high when drilling Tek screws

DON'T...

- ✘ Set directly onto a hard surface without raising slightly with packers for drainage
- ✘ Accelerate rust with acids or salts (but soapy water is ok!)
- ✘ Try and use pop rivets, requires Tek screws for strength
- ✘ Forget the safety gloves when working with steel!

MAKING A 4 PANEL SQUARE / RECTANGULAR PLANTER BOX

JOIN PANELS TOGETHER

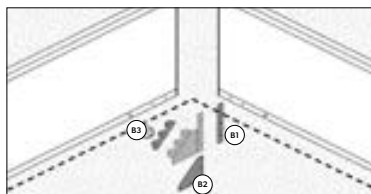

STEP 1 - Use the Corner Join Set (B). Break apart the pieces in the set.

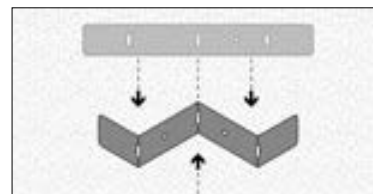

STEP 2 - Take strip piece (B1) and use pliers to shape into staircase pattern.

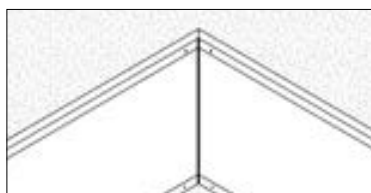

STEP 3 - Stand the two panels at right angles to each other and butt together.

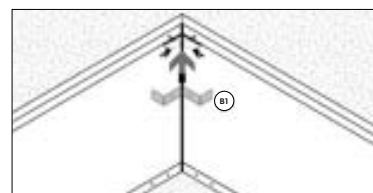

STEP 4 - To join insert top connector 'staircase' piece (B1), align guide holes and screw.

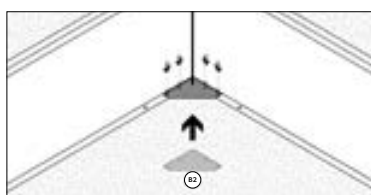

STEP 5 - Slide in foot joiner (B2), align guide holes and screw. (NB screw from below if installing on a hard surface)

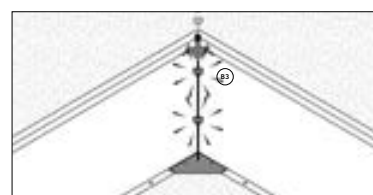

STEP 6 - Firmly grip and hammer arrow shaped wedge pieces (B3) into angled slots at back to fully secure the join.

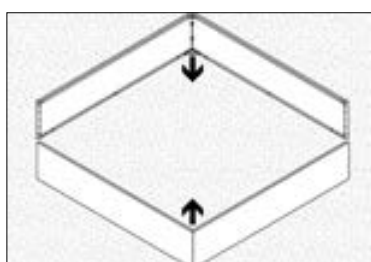

STEP 7 - Repeat above for other pair of panels and then bring them all together

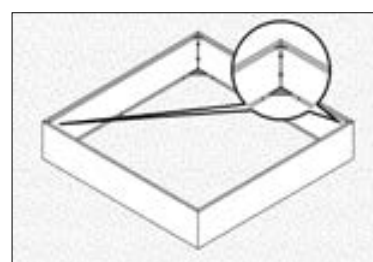

STEP 8 - Complete the last two corner joins

SECURING TO GROUND (OPTIONAL) - If you choose to do this use fixing spikes to secure base through holes in foot. Order these separately if needed.

BACKFILL - evenly to complete, lining the bed first with something like geofabric if necessary

75mm

100mm

150mm

240mm

400mm

560mm

Planter boxes

Custom Easy-Build Planter Boxes

In four easy steps

Step 1: Sketch out your raised garden bed shape including dimensions of all sides.

Step 2: Measure up - On your sketch, mark out all panel sizes required to build your design. Note: Straightcurve® planter panels are available in 400mm, 600mm, 800mm, 1000mm, 1200mm and 2000mm long lengths to make up a 'nearest to' option.

Step 3: Jot down the number of panels of each length needed for your design. Do the same for joining accessories (circle each panel join and tally the number of straight joins, closed corners, and reverse corners required)

Step 4: Brace it right - each straight join in your design will require bracing. Use one bracing strap set where two opposing joins are equal to or less than 1200mm apart. In all other situations, use one universal bracing set (or ground anchor post 1100mm + fitting set) per straight join. Make a note of how many of each type of bracing you need on your sketch.

MOST POPULAR

Panels (1200) = 6
 Panels (600) = 2
 Closed Corners = 4
 Straight joins = 4
 Bracing Straps Set (BSS) = 2

Panels (600) = 12
 Closed Corners = 5
 Reverse Corners = 1
 Straight joins = 6
 Bracing Straps Set (BSS) = 2
 Universal Bracing Set (UBS) = 2

Panels (600) = 4
 Panels (800) = 12
 Closed Corners = 6
 Reverse Corners = 2
 Straight joins = 8
 Bracing Straps Set (BSS) = 2
 Universal Bracing Set (UBS) = 4

GET FUNKY

Panels (1200) = 6
 Panels (1000) = 2
 Closed Corners = 5
 Reverse Corners = 1
 Straight joins = 2
 Universal Bracing Set (UBS) = 2

GREAT FOR CORNERS

Panels (400) = 5
 Panels (800) = 3
 Panels (1200) = 1
 Closed Corners = 4
 Reverse Corners = 3
 Straight joins = 1
 Universal Bracing Set (UBS) = 1

MAKING A CUSTOM EASY-BUILD PLANTER BOX

Scan or click to watch install video



▶ INSTALL GUIDE

NOTE: ALL PANELS REQUIRE JOINING

1. REFER TO MAKING A 4 PANEL SQUARE / RECTANGULAR PLANTER BOXES TO SEE THE CLOSED CORNER JOIN.

2. STRAIGHT JOINS ARE DONE LIKE SO:

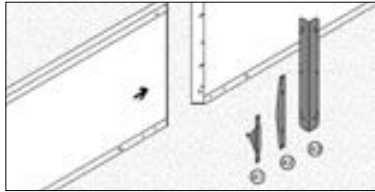

STEP 1 - For a straight join (two panels in a line) use the Straight Join Set (A). Separate the pieces in the set.

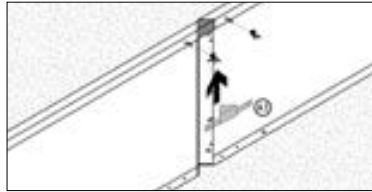

STEP 2 - Stand the first two panels together on a flat surface and insert top connector piece (A1), align guide holes and screw.

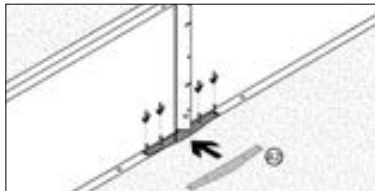

STEP 3 - Slide in foot joiner (A2), align guide holes and screw.

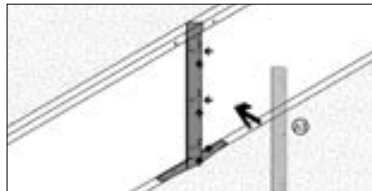

STEP 4 - Fit back rib (A3) flush to align guide holes and screw.

3. REVERSE CORNERS ARE DONE LIKE SO:

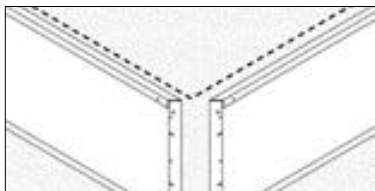

STEP 1 - For a reverse corner stand the two panels in the L shape formation and butt them together.

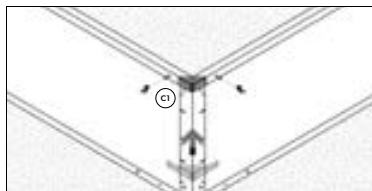

STEP 2 - From the reverse corner join set (C), insert (slide in) the top piece (C1) as shown and align guide holes and Tek screw in place.

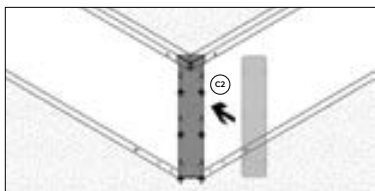

STEP 3 - Position the back fixing plate (C2) align and Tek screw through guide holes to secure.

75mm

100mm

150mm

240mm

400mm

560mm

Planter boxes

BRACING REQUIRED FOR STRAIGHT JOINS

YOU HAVE THREE OPTIONS:

A. WHERE TWO OPPOSING JOINS ARE LESS THAN 1200MM APART

- BRACING STRAP SET:** One Bracing strap set (two lengths) will span as a cross brace between the two joins as shown. The braces run diagonally from the top of both straight joins to the bottom of the opposite straight joins. These are designed to cater for different spans, simply breakaway to required span by hand, by bending back and forth, then attach with lock pins supplied.

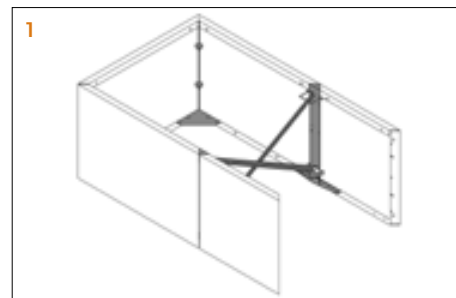

B. FOR STRAIGHT JOINS GREATER THAN 1200MM APART - if not directly opposite another straight join use either:

- UNIVERSAL BRACING SET:** The universal Bracing set will hook into top hole in join rib and anchor to the ground. Adjust final tension with the turnbuckle. This is real easy.
- THE GROUND ANCHOR SET - 1100MM:** Installed near to the straight join, installing the post first then using the fitting set to screw and secure panel to the post. This involves a little digging!

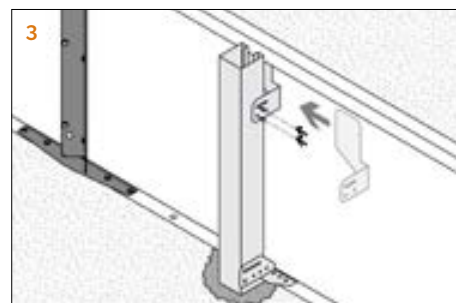
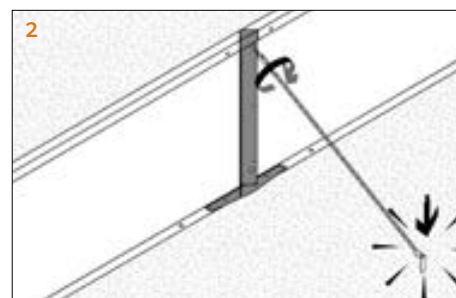

MAKING DIFFERENT HEIGHT PLANTER BOXES

The Planter Boxes will look great in combination, with different heights placed together. Note that our Zero-Flex Raised Garden Bed 240mm product has the same profile/look, if you'd like to add that height to the mix! Setting all planters perfectly level is key to achieving this look.

SPECIAL CASE - USING A 2000MM PANEL

These panels are not listed here but can be found in the Zero-Flex Raised Garden Beds product pages. Investigate there if you want to build an XL four panel planter and note the bracing requirements for that size.

Technical Drawings

75mm

100mm

150mm

240mm

400mm

560mm

Planter boxes

STRAIGHTCURVE® ZERO-FLEX RAISED GARDEN BED PANEL - 400MM

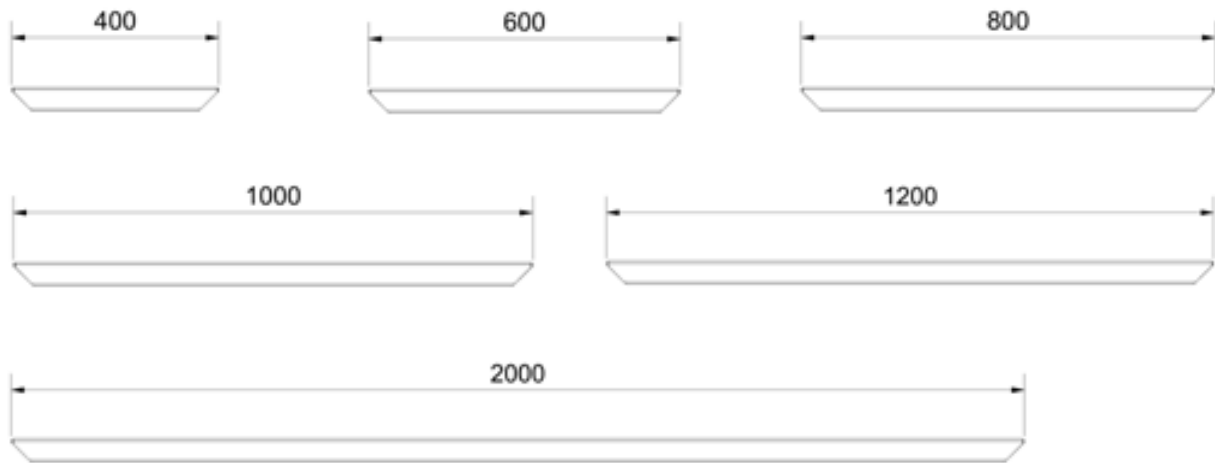

PANEL END/JOIN FLANGE

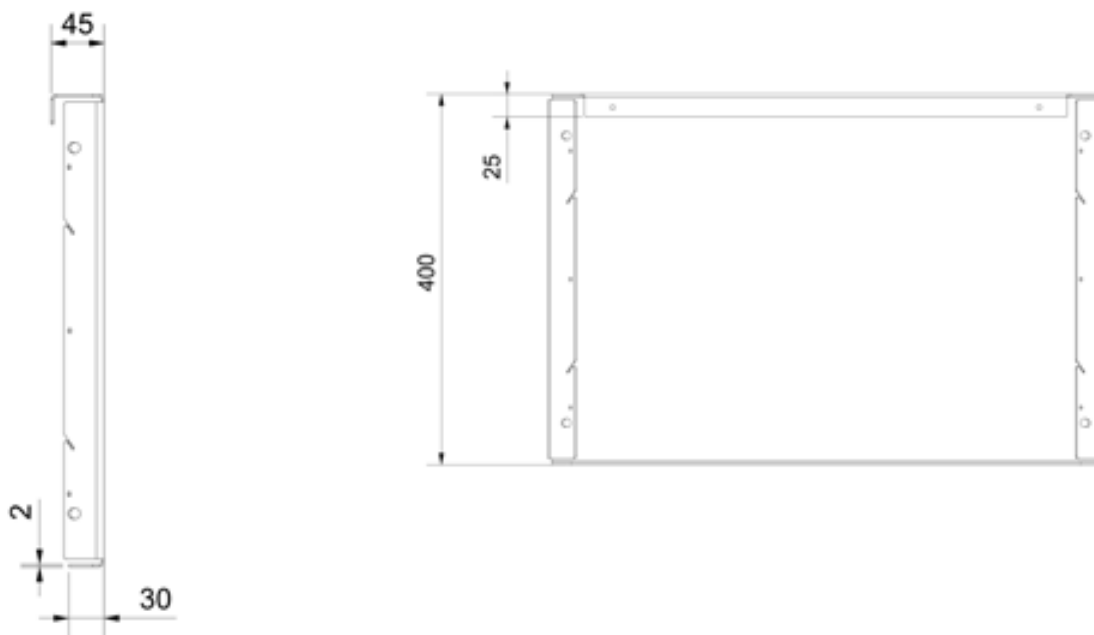

NOTE: Foot holes not shown in these diagrams are of 9mm diameter



75mm

100mm

150mm

240mm

400mm

560mm

Planter boxes

STRAIGHTCURVE® ZERO-FLEX RAISED GARDEN BED PANEL - 560MM

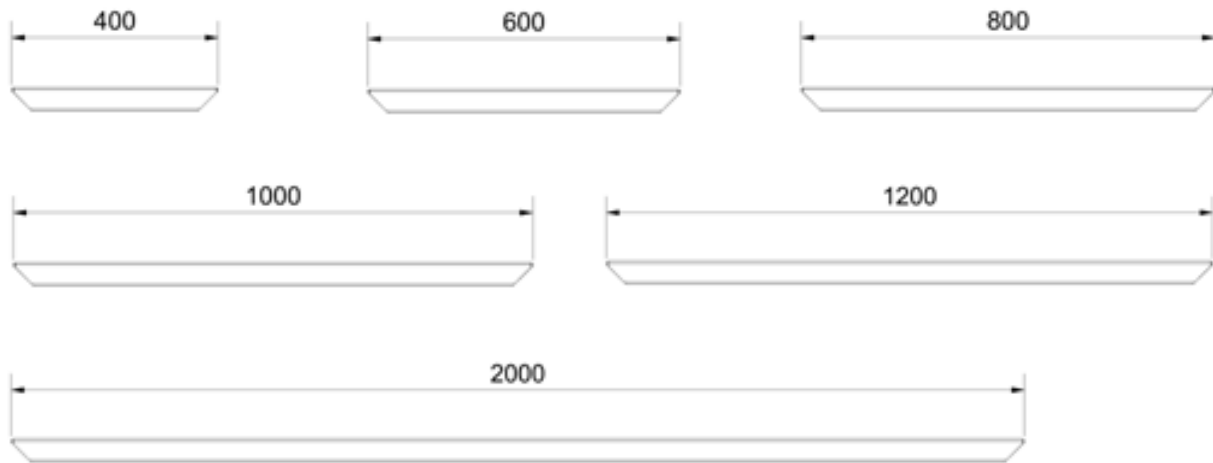

PANEL END/JOIN FLANGE

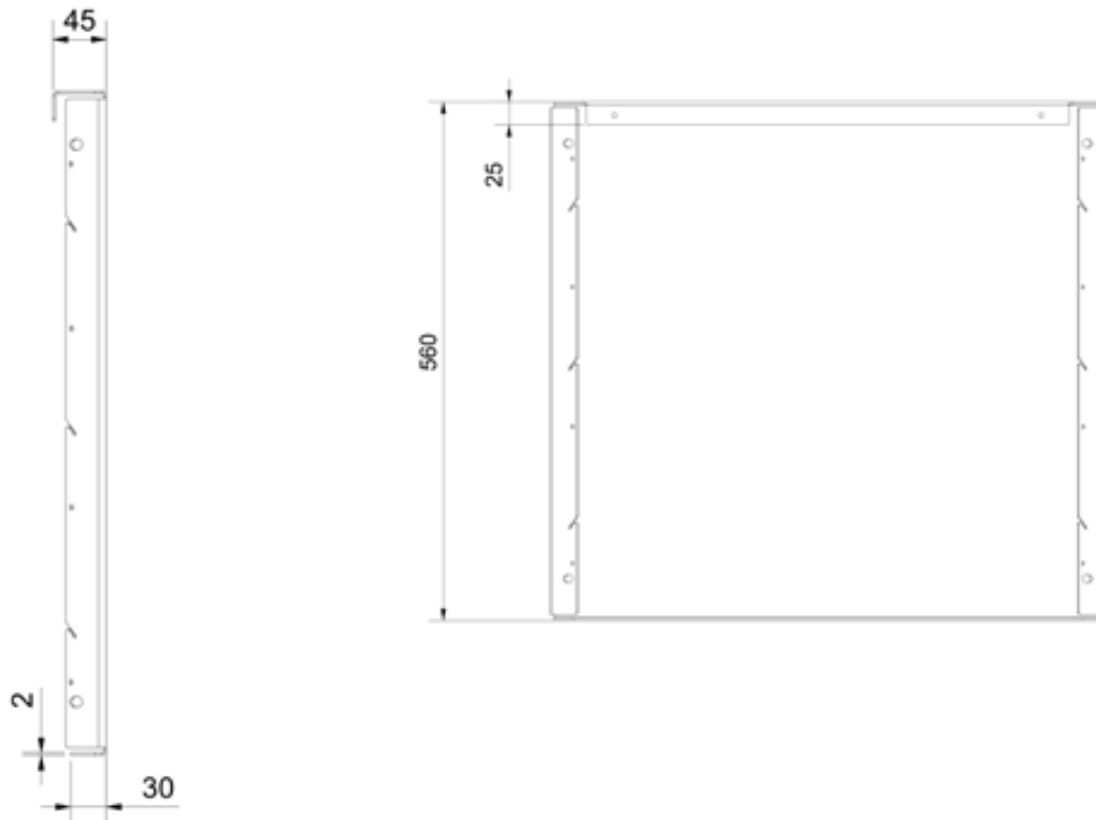

NOTE: Foot holes not shown in these diagrams are of 9mm diameter

Section 2:

Knowledge Builder



More Knowledge
Builder Content
Coming Soon...
here's a taster!

1. How quickly does the weathering steel change colour & how long will it last?



ABOUT THAT COLOUR

The change of colour occurs because of the natural process of patina formation upon the surface giving it the timeless rusty look. This process is a result of exposure to the elements; in particular moisture and air. It's difficult to predict the pace of this colouration as it depends on various local circumstances and the season of installation. In more humid conditions or wetter seasons, you can see a change occurring within days and weeks though it can still take months for a solid even patina to develop.

SOMETHING YOU CAN DO TO ASSIST PATINA DEVELOPMENT

To move it along, use soapy water and rub the surface down a few times allowing a significant dry time in between applications. This assists even patina development by dispersing residual oils on the surface. Do not be tempted to use acids or salts to speed things along, this will prevent the formation of a healthy patina and can be detrimental to lifespan. By the way, some people buy early and pre-rust before installation. If doing this make sure it's unstacked and can air dry well with no pooling of water on any surfaces.

A COATING OF PROTECTION

Weathering steel is always changing slowly in terms of colour, further darkening as the years pass. The patina you see not only looks good but is also the weathering steels protective coat, that continually regenerates on the surface to prevent the aggressive, unsightly rusting you see with mild steel. This is why weathering steel is used so much in outside locations.

WHAT THIS MEANS FOR LIFESPAN

In terms of lifespan, it's impossible to adopt a one size fits all promise with the variety of soil and atmospherics that can impact this natural process of corrosion at work. We know weathering steel edging can last decades and hold its structural integrity even as it corrodes. This is a product deserving of its long-lasting credential, but not one to carry a fixed guarantee due to all the factors in play.

SOME MORE INFO & TIPS

We have a Longevity Guide and Product Care Guide on our website footer where you can learn more and take some actions if you choose to prior to installation.

As an aside...

Weathering Steel is known by various brand names, most notably Corten. The abbreviation of the original brand name Cor-Ten, highlights its corrosion resistance and tensile strength as key qualities. All Weathering Steel regardless of brand, whether this is Corten, Redcor, SSAB or others have very similar composition in line with the used standard for Weathering Steel (ASTM, EN ISO, BS ISO, DIN, etc) with the same performance expectations. The unique properties of Weathering Steel are what see it perform very differently from typical Mild Steel.

Straightcurve® weathering steel is simply better for those who love an organic and natural looking finish for their garden scape.

Does this bring up another question for you? Feel free to further the discussion with your Straightcurve® goto person

Section 3:

Straightcurve[®] Terminology









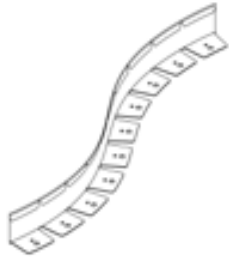

Straightcurve® Terminology



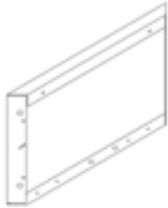

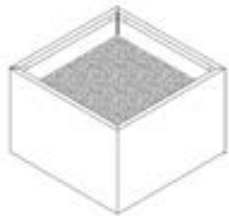
A handy guide to Straightcurve® language

This guide includes;

- correct terminology for our range, products and accessories
- numbered terms with one illustrated example shown
- basic description and key for where the term is used and/or found







RANGE	ONE EXAMPLE	DESCRIPTION	REFERENCE KEY
Flex		Naturally flexible to easily make smooth, even curves (product code prefixes used are FL)	
Rigid		Rigid for firm straights. The 100/150mm heights have a little give for subtle curves (product code prefixes used are RL)	
Zero-Flex		Not flexible, use for unmovable straight lines (product code prefixes used are RL/FHL/HL)	
Planter box		Panels purchased in kits or custom selected with their join types	

- ★ Most or all
- ⬠ F FL075
- ⬠ Z ZF(RL)075
- ⬠ F FL100/150
- ⬠ R RL100/150
- ⬠ Z ZF(HL)100/150
- ⬠ F FL240
- ⬠ R RL240
- ⬠ Z ZF(FHL)240
- ⬠ F FL400/560
- ⬠ R RL400/560
- ⬠ Z ZF(FHL)400/560
- ⬠ P Planter box(FHL)400/650





TERM	ONE EXAMPLE	DESCRIPTION	USED WITH
1 Discreet joins		Near seamless joins everytime due to guide hole precision	★
2 Pre-attached		Connector plates are attached at the factory with heavy duty rivets	⬠ F ⬠ Z ⬠ F ⬠ R ⬠ Z
3 Installed length		Stated length equals installed length	★
4 Guide holes		Precision 4mm guide holes for exact alignment of joins	★
5 Fixing spikes		300mm galvanised fixing spikes	★

Straightcurve® Terminology

A handy guide to Straightcurve® language

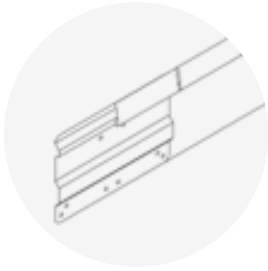



TERM	ONE EXAMPLE	DESCRIPTION	USED WITH
6 Tek screws		12G x 16mm Dacromet or Zinc colour hex head screws	★
7 Driver bit		To suit our hex head self tapping Tek screws	★
8 Rolled top		Descriptor for single and double rolled rounded tops	★
9 Stabilising foot/feet		One or two-sided continuous grounding foot/feet	★
10 Notches		Evenly spaced gaps in back of top lip to allow even flex	

- ★ Most or all
- F** FL100/150
- F** FL240
- F** FL400/560
- F** FL075
- R** RL100/150
- R** RL240
- R** RL400/560
- Z** ZF(RL)075
- Z** ZF(HL)100/150
- Z** ZF(FHL)240
- Z** ZF(FHL)400/560
- P** Planter box(FHL)400/650



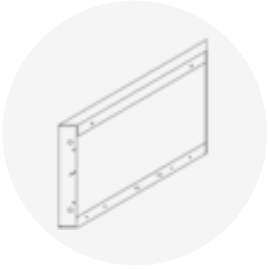

TERM	ONE EXAMPLE	DESCRIPTION	USED WITH
11 Connector plate		Pre-attached plate, with strengthening rib and guide holes	F Z F R Z
12 Pop rivets		4mm shaft stainless steel pop rivets for garden edging only	F Z F R Z
13 500mm Corner piece		Comes straight with 250mm arms and fold lines cut in	Z F R Z
14 Fixing pegs		350mm peg with strengthening rib and lock in tab	F R
15 Heavy duty peg (HDP)		300mm extra strong peg with shoulder for hammering	F R

Straightcurve[®] Terminology

A handy guide to Straightcurve[®] language



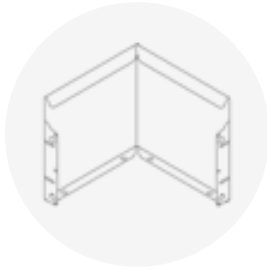
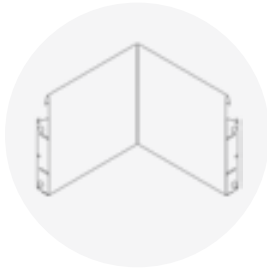

TERM	ONE EXAMPLE	DESCRIPTION	USED WITH
16 Hard surface fixing bracket (HSFB)		Angle set on ground for the edge to hammer onto	F R
17 Panel		Describes raised garden bed/planter box lengths	★
18 Bracing ribs		Prefitted movable bracing ribs for bracing system attachment	F R F R
19 Bracing Rib ZF		Bracing rib to fit to 2000mm ZF(FHL) panel	Z P
20 Join set		Breakaway parts include join bracket, sliders and wedges for joining panels	F R F R

- ★ Most or all
- ⬢ F FL075
- ⬢ Z ZF(RL)075
- ⬢ F FL100/150
- ⬢ R RL100/150
- ⬢ Z ZF(HL)100/150
- ⬢ F FL240
- ⬢ R RL240
- ⬢ Z ZF(FHL)240
- ⬢ F FL400/560
- ⬢ R RL400/560
- ⬢ Z ZF(FHL)400/560
- ⬢ P Planter box(FHL)400/650



TERM	ONE EXAMPLE	DESCRIPTION	USED WITH
21 Join bracket		Inserts under top lip and above join flanges when joining	F R F R
22 Slider & wedge		Work in with join slots to lock panels together	F R F R
23 Corner piece		Pre-made 90 degree corner for right angles with 255mm arms	F R F R
24 Reverse Corner piece		Pre-made reverse L-shape corner with 255mm arms	F R F R
25 Join part for offcuts		For joining offcuts of panels together, fit to face by screwing through guide holes	F R F R

Straightcurve[®] Terminology

A handy guide to Straightcurve[®] language



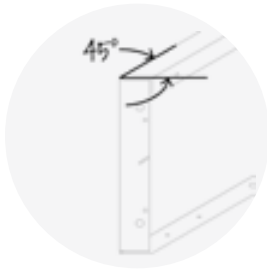
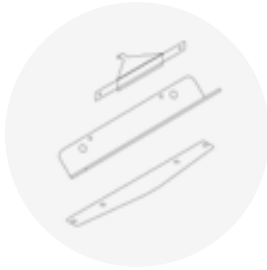

TERM	ONE EXAMPLE	DESCRIPTION	USED WITH
26 Ground anchor post -470mm		470mm Post to attach to 240mm bracing rib with screws	F R
27 Ground anchor set -470mm		U-shape profile post and fitting lip	Z
28 Fitting lip		Fitting lip that screws to anchor post once positioned	Z
29 Universal bracing set		Includes turnbuckle, T-stake and cable or chain with carabiner style clip.	F R Z F R Z P
30 Join flange FL/RL		Folded back panel ends with join slots and guide holes	F R F R

- ★ Most or all
- ⬢ F FL075
- ⬢ Z ZF(RL)075
- ⬢ F FL100/150
- ⬢ R RL100/150
- ⬢ Z ZF(HL)100/150
- ⬢ F FL240
- ⬢ R RL240
- ⬢ Z ZF(FHL)240
- ⬢ F FL400/560
- ⬢ R RL400/560
- ⬢ Z ZF(FHL)400/560
- ⬢ P Planter box(FHL)400/650

TERM	ONE EXAMPLE	DESCRIPTION	USED WITH
31 Join flange join slots		Align snug for slider and wedge join system to lock into	F R F R
32 Join Flange ZF		45 degree fold back on panel ends (ZF/FHL products)	Z Z P
33 Straight join set		Join set includes top joiner, foot plate and back plate	Z Z P
34 Closed corner set		Join set includes top joiner, foot plate and arrow clasp piece(s)	Z Z P
35 Reverse Corner set		Join set includes top joiner and back plate	Z Z P

Straightcurve® Terminology

A handy guide to Straightcurve® language

TERM	ONE EXAMPLE	DESCRIPTION	USED WITH
36 Ground anchor post - 1100mm		1100mm U-shape profile galvanised post	FR
37 Ground anchor set - 1100mm		1100mm U-shape profile galvanised post with fitting set	FRZ P
38 Fitting Set		Two parts for top and foot attachment of post to panel	FRZ P
39 Bracing strap set		Snap to span crossover brace straps with lockpins	ZP