

100mm Garden Edging

For curved and straight edging situations.

Do you know what edging product is best for your project? Let's figure that out together here!

Firstly, what are you trying to do?



LAWN EDGE

Lawn edge for non-invasive grasses and ground covers

OR



PATHWAYS/RETAINING

Paving, stone and crush retainer edge

OR



DIVIDER

Divider between gravels/ woodchips/ mulches etc

Perhaps it looks something like these?



Straightcurve® Flex Garden Edging - 100mm



Straightcurve® Zero-Flex Garden Edging - 100mm

How do you choose from our three 100mm edging options?

We have solutions for curved and straight edging situations. Consider what matters to you so you can be sure of selecting the best option from our range. It's your call and we hope this selection table makes it easier!

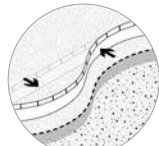
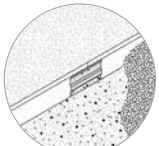
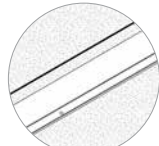
I'm looking for...	We recommend for this ...		
			
	Flex - 100	Rigid - 100	Zero-Flex - 100
Something I can do myself	✓	✓	✓
Something flexible enough to make tight curves with ease	✓	✗	✗
Tree rings	✓	✗	✗
An edge that creates a strong gentle curve, for a radius exceeding 4m	✗	✓	✗
Something rigid that helps me to create a straight run	✗	✓	✓
A straight edge that will stay true and won't waver	✗	✗	✓
An edge ideally suited to run pavers up to, instead of a concrete haunch	✗	✗	✓

Did you know? It's also possible to combine styles, as our Flex Garden Edging and Rigid Garden Edging are join and profile compatible. Flex edging can also be modified to join the Zero-Flex edge neatly.

Product overview

ROUNDED TOPS AND SAFETY FEATURES

The smooth, rolled tops and rounded connector plate corners assist safe handling. When installed, all joins/fixings are internal so that the exposed top and front present as a smooth top edge and continuous fascia.

SAFER AND CLEANER HANDLING

We recommend wearing gloves as the manufacturing process can leave residual oils/dust and our products can get hot when exposed to sunlight. Our products are shipped in bundles, when lifting bundles handlers should be mindful of their carrying capabilities. Single items are easy to carry for one person (see product weights).

ABOUT WEATHERING STEEL

The manufacturing process of weathering steel leaves the surface in a dark, almost black state. This dark 'finish' is an oxide layer that forms during the hot rolling process. The weathering process needs to break this layer down first before the desired protective patina layer can be established. You can expect some inconsistency in the patina formation because the thickness of the oxide layer varies; it'll appear spotty with some areas going orange and others still black.

The patina develops naturally with periods of wet and dry, and both phases are key for its steady formation. Do not wet continually without allowing time for thorough drying. A faster patina formation can be aided by cleaning the surface with soapy water to remove oil residue, but anything harsher is not advised as it can be detrimental to patina development and consequently, reduce product lifespan. Some rust solution products are safe to use as these 'build a surface patina' rather than just accelerating rusting.

WHAT IS A PATINA

Patina is not the same as rust. All rust is patina, but not all patina is rust. Patina is a chemical bond between various elements and usually oxygen. It can be found on most metals with the exception of 8 inert (noble) metals like gold or silver. 'Normal' rust is iron-oxide, the patina referred to above is mostly a bond between copper, phosphorus, chromium, nickel, iron and oxygen. You may wonder, how does water feature in it? Water acts as an electrolyte, but

that's a different story. In the end, the patina formed on weathering steel is a dense layer that doesn't flake or allow oxygen through. Therefore, once formed, the oxidation process slows down dramatically.

LONGEVITY

Our products are of the highest quality ensuring longevity in the given environment. For further information please refer to the "Longevity Guide" and "Product Care Guide" on our website.

PAINTING, SEALING AND POWDERCOATING

Our galvanised products are suited to painting, but the surface should be thoroughly prepared (using acetone wash), and sealed with a metal primer (etch primer is very good) to maximise topcoat adhesion.

Powdercoating is a much more durable/hardy choice, and can be requested for large projects with lead times/costings supplied. It is worth noting that not all powdercoating performs the same, we use and recommend Interpon powder from AkzoNobel for assured quality and maximum endurance and suggest you request the same. It's also worth asking first to see a sample from your chosen powdercoater specialist.

Another question we get relates to freezing the colour (or patina development) at a certain stage. That's possible using a transparent sealant suitable for steel. Keep in mind that the colour will change when applying a sealant, it'll get a 'wet' look. Be sure to test this in a small inconspicuous area first before fully committing. This will require reapplication once a year.

HOW TO POSITION THE EDGE

The Flex and Rigid Garden Edging have a back and a front facing side. Consider which side will be the most visible in situ, based on your garden design and likely use of the area. For example, in a lawn edging install the smooth side would often face the lawn side so a smooth top portion presents with the neatly clipped lawn. These two edge styles do not have a foot which makes them ideal for retrofits along slightly crowded garden bed edges.

The Zero-Flex Garden Edging has no back or front facing side, so it looks smooth from both directions. The fixing screws and galvanised nails are used in the foot portion only, so they are hidden by the fill material used.

Fills such as mulch and stone may settle at lower than the install level and so require topping up later to maintain the look initially achieved. This top up practice can also increase lifespan, as the protective patina formation may be inconsistent in previously buried portions.

HOW DEEP DO I BURY THE EDGE?

The Flex and Rigid Garden Edging is designed to be mostly buried both in terms of the aesthetic finish and to maximise its strength and durability. Curved installs do generate a strength of their own so some layouts allow Flex to be set higher and still maintain its line well. Not burying the edge at all will leave join systems visible and see the edge more vulnerable to damage.

The Zero Flex Garden edging only requires partial burying to hide the foot, but when mostly buried its strength and durability are greatest of all. Installed on a firm base and with fill near flush to the top of the edge it is impressively strong.

You may choose to leave a portion of the edge proud to help with material separation and containment, or for lawn maintenance practices of strimming against the edge itself.

NO MORE TEK SCREWS FOR FLEX AND RIGID?

You can now experience the improved connector plate for Flex and Rigid Garden Edging with the unique click-connect system. Intuitive, even faster to install, no tools needed and maintaining strength throughout.

TEK SCREWS FOR ZERO-FLEX

You will see the pre-attached connector plate is fixed to the edge with rivets. This is the best method in the factory but when installing Zero-Flex Tek screws are a faster and stronger. We recommend using the long lasting, grey Dacromet® Tek screws for all internal (buried) screw locations. With a weathering steel install, and on the rare occasions when the screws are visible the zinc colour Tek screws are used as they rust over, making them less aesthetically intrusive. However, if you choose to use rivets be sure to use stainless steel and not aluminium. Aluminium, like zinc, is a sacrificial anode that protects the steel by sacrificing itself and will disappear within a year.

ADVANTAGES

- ✓ Strong click-connect system
- ✓ Continuous smooth rolled tops
- ✓ Corners available or easily made in situ
- ✓ Up to 3x faster installation
- ✓ No welding required
- ✓ No Experience/training needed
- ✓ Designed for ease of use

Straightcurve® Flex Garden Edging - 100mm

2024
VERSION

FL100WS WEATHERING STEEL | FL100GS GALVANISED STEEL

Product features

The details that make the difference



Click-Connect plate for quick and easy installation with discreet joins



4 mm rounded tops for child and pet safety

Double Rolled, Notched Top and Bottom for more smoothness and even curves



Discreet presence for retrofits and design integrity



Moveable Spike and Holder for easy obstacle avoidance and strong hold for top and bottom

EDGE STYLE



FINISHES

- Galvanised Steel
- Weathering Steel

For smoothly curving edging applications that hold position once shaped and installed.

100mm

Product specifications

TECHNICAL SPECIFICATIONS

Length (Installed)	1800mm
Top edge thickness	4mm
Steel plate thickness	1.6mm
Weight per length	2.9kg

SINGLE SET INCLUDED

Connector plate	Pre-attached
Spike + holder	Set of 3

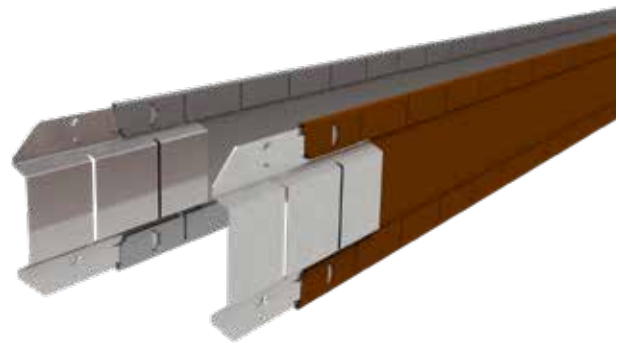

SOLD AS BOX SET INCLUDING

- 4 x 1800 mm length (7.2 m)
- 4 x Click-Connector plate
- 12 x Stainless Steel Spike holder
- 12 x Galvanised Fixing Spikes, 300mm long

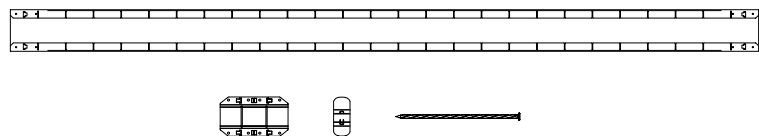

ALTERNATIVE LENGTHS

Short set 800 mm

- 2 x 800 mm length (1.6 m)
- 2 x Click-Connector plate
- 2 x Stainless Steel Spike holder
- 2 x Galvanised Fixing Spike, 300mm long

Filler pack 400 / 200 mm

- 1 x 400 mm length
- 2 x 200 mm length
- 3 x Click-Connector plate
- 1 x Stainless Steel Spike holder
- 1 x Galvanised Fixing Spike, 300mm long

ADDITIONAL ACCESSORIES

- 400mm Corner piece (200 + 200mm arms, bend to desired angle)

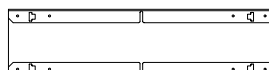

100mm Flex Installation Guide

Scan to watch the installation video



RECOMMENDED TOOLS

- Ground leveling tools
- Hammer
- Rubber mallet
- Angle grinder (only required if modifying lengths or fashioning ends)

PREPARATIONS

Mark the intended line on the ground and measure what length of edge is needed. Making a trench to set the edge into is usually necessary. This will dictate the amount of edge that finishes proud and visible for your buried edge. For a retrofit, where surrounding heights are set, trench relative to these. For a new garden where surrounding materials may be added, the edge is sometimes installed without a trench, and then materials are filled up to and around it. Either way, burying the edge more deeply adds strength and assists curve support.

Note: This edge allows gentle sloping. Corners can be made or purchased as accessories. Length excess is cut away with angle grinder tool.

DO...

- ✓ Consider the best edge orientation in terms of smooth face/top edge viewing
- ✓ Join all lengths in place and perfect the line before finally fixing in position
- ✓ Use some spikes to hold partially in place while reviewing position
- ✓ Flex rather than bend, especially if creating rings

DON'T...

- ✗ Use for straight lines, instead use Rigid or Zero-Flex
- ✗ Forcibly bend. Take care and gently flex the edge to shape
- ✗ Accelerate rust with acids or salts, that's harmful to patina development
- ✗ Leave a square top corner unsafely protruding at an end, cap or round it off with a grinder instead

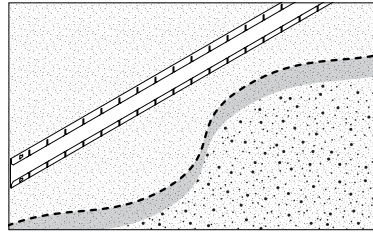

STEP 1 - Mark edge line on ground or by trenching and lay edge pieces nearby.

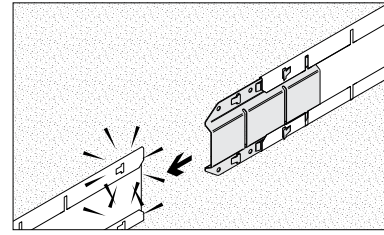

STEP 2 - Slide connector plate into one end of a strip until it clicks in. Connect multiple lengths and attach all in the same way.

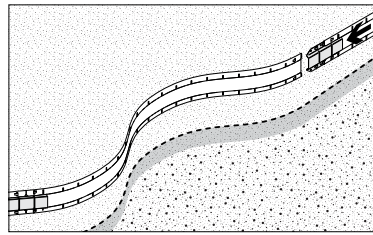

STEP 3 - Set the edges upright, connect further lengths and shape as required.

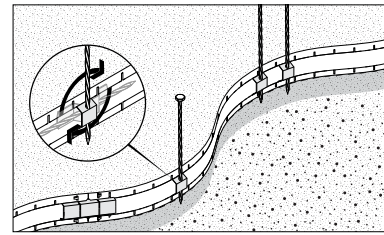

STEP 4 - Push the spikes in the spike plates. Slide and rotate them together under the folded lips at a desired location.

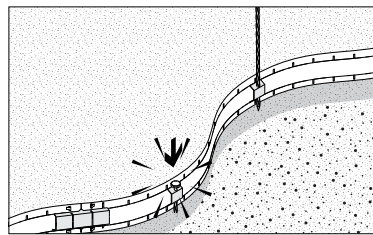

STEP 5 - Secure your edge in place by hammering the spike into the ground. Adjust shape and spike location where necessary.

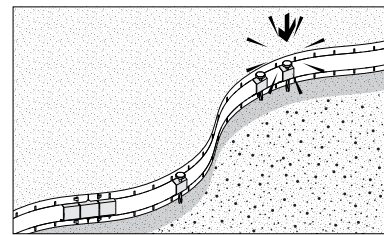

STEP 6 - Repeat this until all spikes have been used up. As a tip: concentrate spikes where tension is the highest.

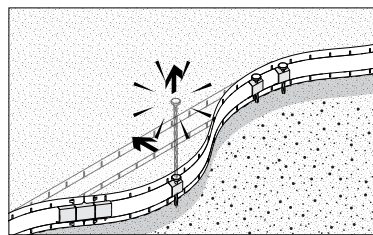

STEP 7 - If you found the shape isn't quite right or you need to move the spike for unforeseen reasons, use a clawhammer to pull the spike out and reposition the edge or move the spike to a better suited location.

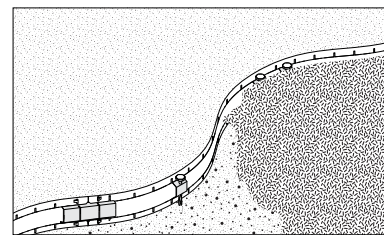

STEP 8 - Backfill to finish.

CORNERS

Standard corners are available for purchase, but you can choose to make your own. Making your own corners will likely mean less waste, as the corners are simply made where they are needed with no offcuts created.

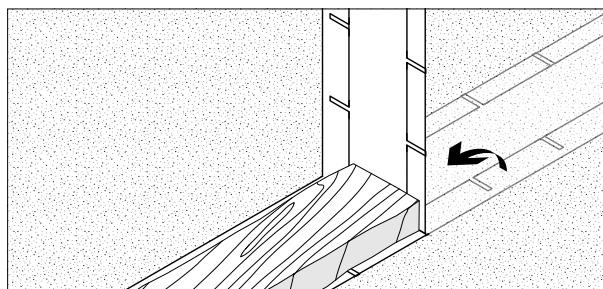

Bend in the corner by hand and finish shaping with a rubber mallet. Placing a block of wood close to the fold improves the result.

JOINING EDGE TO A SURFACE OR ROCK

A join tab can be made using an angle grinder. This involves cutting away the top lip portion and scoring a fragmented fold line for the remaining tab piece. The tab is then bent as required for fixing and screwing to the surface it joins.

If butting up to a rock, using a diamond tip blade to cut a slot in the rock itself allows the edge to sit into it snugly, or just use the rock to hide the edge end safely behind it.

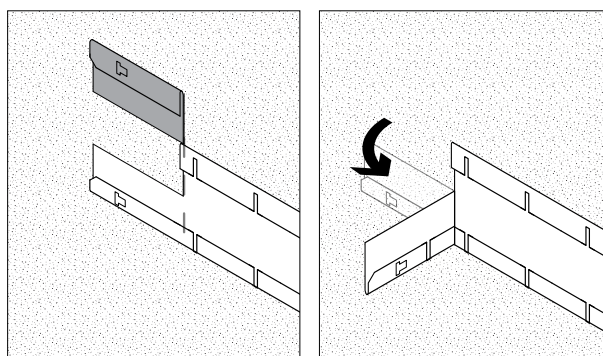

INSTALLING ON HARD SURFACES

Where ground conditions are too hard for standard spikes to penetrate, you can use a drill to make holes where you would like to fix your edge in place. Create 9 mm holes for a snug fit or 8.5 mm holes to hammer the spike stuck. To suit your situation you can adjust the length of the spike with a grinder.

Alternatively on impermeable surfaces such as concrete, use DynaBolts™ or other concrete screws with the spike holder to fix your edge in place. Make sure to use packers to elevate the edge slightly; allowing drainage away from edge.

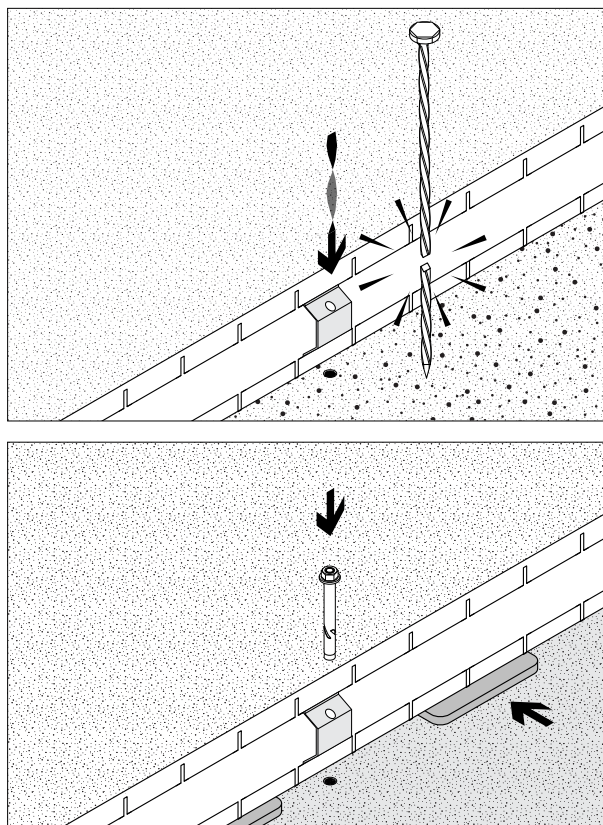

CIRCLES AND TIGHT CURVES

One length makes a tight 57 cm diameter circle. Take care to gently flex the edge (i.e. do not bend) when forming the ring. Once the connector plate is aligned, click and connect, then carefully adjust ring shape to your liking and fix to ground.

The tight ring made with one length is not completely smooth on the inside. You can add part of a length or shorter lengths to get a smoother result. Using whole lengths only the diameters increase with each additional length, i.e. 114cm, 172cm, 229cm and so on.

As a guide the tightest curves without kinking the steel is equivalent to a radius of around 29cm. A further tip to achieve a tighter curve is to use your angle grinder to cut additional notches into the top and bottom lip in the section where it's needed.

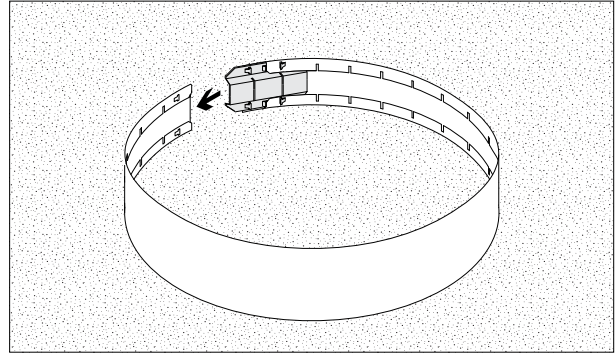

COMPATIBILITY

The 100mm Flex is compatible with the 100mm Rigid, because the joining plates and edge profile are exactly the same. This means you can use both together on the same project!

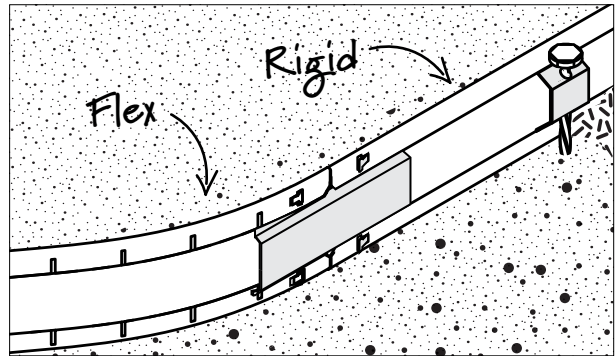

Straightcurve® Rigid Garden Edging - 100mm

2024
VERSION

RL100WS WEATHERING STEEL | RL100GS GALVANISED STEEL

Product features

The details that make the difference



Click-Connect plate for quick and easy installation with discreet joins



4 mm rounded tops for child and pet safety

Double Rolled, Notched Top and Bottom for more smoothness and even curves



Discreet presence for retrofits and design integrity





Moveable Spike and Holder for easy obstacle avoidance and strong hold for top and bottom

EDGE STYLE



FINISHES

-  Galvanised Steel
-  Weathering Steel

For creating straight or slightly curving lines

100mm

Product specifications

TECHNICAL SPECIFICATIONS

Length (Installed)	1800mm
Top edge thickness	4mm
Steel plate thickness	1.6mm
Weight per length	3.0kg

SINGLE SET INCLUDED

Connector plate	pre-attached
Spike + holder	set of 3



SOLD AS BOX SET INCLUDING

- 4 x 1800 mm length (7.2 m)
- 4 x Click-Connector plate
- 12 x Stainless Steel Spike holder
- 12 x Galvanised Fixing Spikes, 300mm long

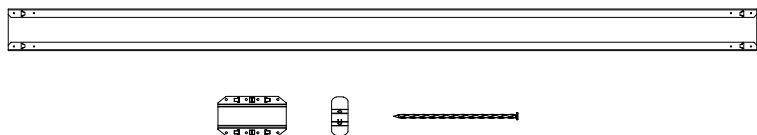

ALTERNATIVE LENGTHS

Short set 800 mm

- 2 x 800 mm length (1.6 m)
- 2 x Click-Connector plate
- 2 x Stainless Steel Spike holder
- 2 x Galvanised Fixing Spike, 300mm long

Filler pack 400 / 200 mm

- 1 x 400 mm length
- 2 x 200 mm length
- 3 x Click-Connector plate
- 1 x Stainless Steel Spike holder
- 1 x Galvanised Fixing Spike, 300mm long

ADDITIONAL ACCESSORIES

- 400mm Corner piece (200 + 200mm arms, bend to desired angle)

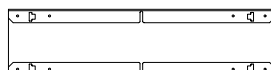

100mm Rigid Installation Guide

Scan to watch the installation video



RECOMMENDED TOOLS

- Ground leveling tools
- Hammer
- Rubber mallet
- Angle grinder (only required if modifying lengths or fashioning ends)

PREPARATIONS

Mark the intended line on the ground and measure what length of edge is needed. Making a trench to set the edge into is usually necessary. This will dictate the amount of edge that finishes proud and visible for your buried edge. For a retrofit, where surrounding heights are set, trench relative to these. For a new garden where surrounding materials may be added, the edge is sometimes installed without a trench, and then materials are filled up to and around it. Either way, burying the edge more deeply adds strength and assists support. Consider the 240mm edge if more visibility of edge face is desired.

Note: This edge allows gentle sloping. Corners can be made or purchased as accessories. Length excess is cut away with angle grinder tool.

DO...

- ✓ Use for straight lines or very slight curves
- ✓ Consider the best edge orientation in terms of smooth face/top edge viewing
- ✓ Take care to position spikes exactly in line
- ✓ Use some Flex lengths if your design has some curved sections, they're compatible!

DON'T...

- ✗ Use for very long straight lines, instead use Zero-Flex
- ✗ Forcibly bend. Rigid lengths will shape gently for a slight curve only
- ✗ Accelerate rust with acids or salts, that's harmful to patina development
- ✗ Leave a square top corner unsafely protruding at an end, cap or round it off with a grinder instead

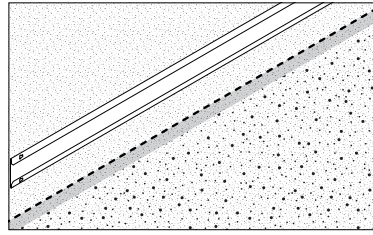

STEP 1 - Mark edge line on ground or by trenching and lay edge pieces nearby.

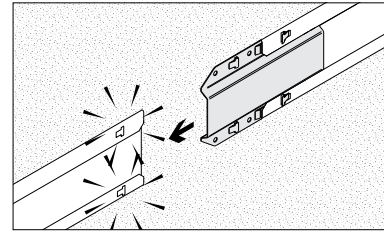

STEP 2 - Slide connector plate into one end of a strip until it clicks in. Connect multiple lengths and attach all in the same way.

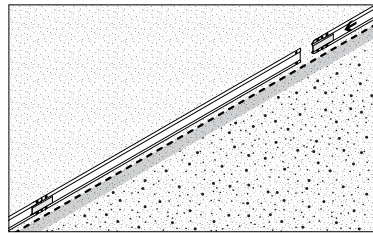

STEP 3 - Set the edges upright, connect further lengths and shape as required.

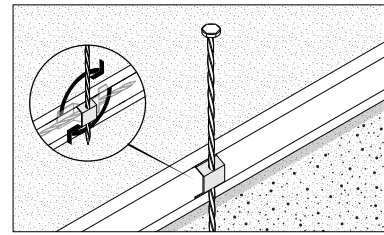

STEP 4 - Push the spikes in the spike plates. Slide and rotate them together under the folded lips at a desired location.

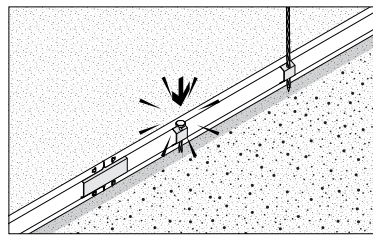

STEP 5 - Secure your edge in place by hammering the spike into the ground. Adjust shape and spike location where necessary.

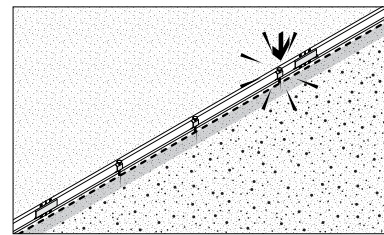

STEP 6 - Repeat this until all spikes have been used up. As a tip: concentrate spikes where tension is the highest

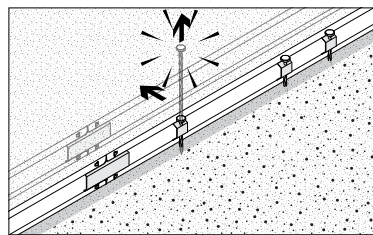

STEP 7 - If you found the shape isn't quite right or you need to move the spike for unforeseen reasons, use a clawhammer to pull the spike out and reposition the edge or move the spike to a better suited location.

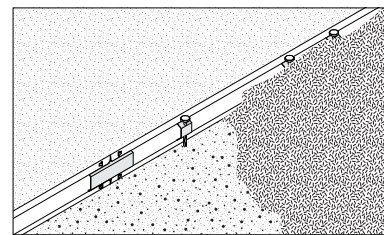

STEP 8 - Backfill to finish.

CORNERS

Standard corners are available for purchase, but you can choose to make your own. Making your own corners will likely mean less waste, as the corners are simply made where they are needed with no offcuts created.

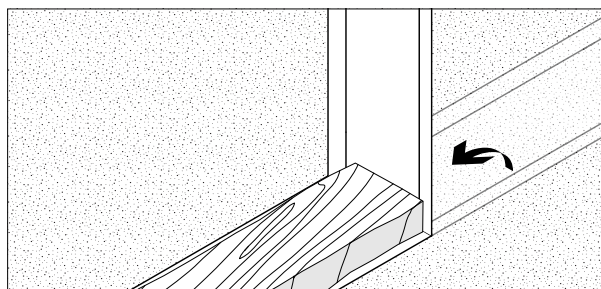

Bend in the corner by hand and finish shaping with a rubber mallet. Placing a block of wood close to the fold improves the result.

GEOMETRIC SHAPES

You may look to create the likes of rectangles or squares such as for tree surrounds. To do so measure carefully and create the corners where needed. Alternatively purchase four corners for an exact 400mm square shape.

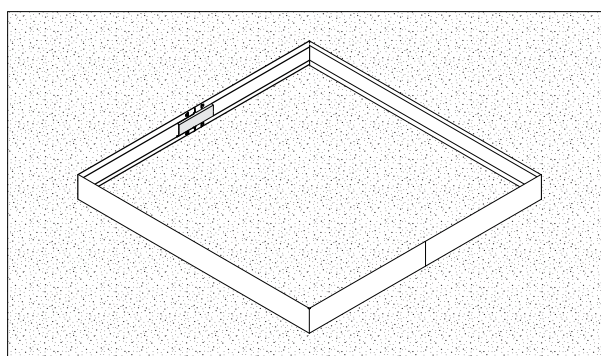

INSTALLING ON HARD SURFACES

Where ground conditions are too hard for standard spikes to penetrate, you can use a drill to make holes where you would to fix your edge in place. Create 9 mm holes for a snug fit or 8.5 mm hole to hammer the spike stuck. To suit your situation you can adjust the length of the spike with a grinder.

Alternatively on impermeable surfaces such as concrete, use DynaBolts™ or other concrete screws with the spike holder to fix your edge in place. Make sure to use packers to elevate the edge slightly; allowing drainage away from edge.

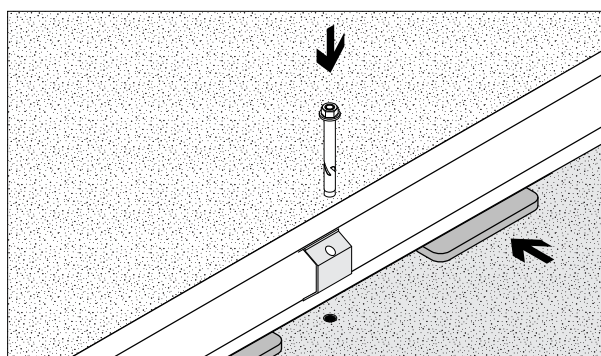
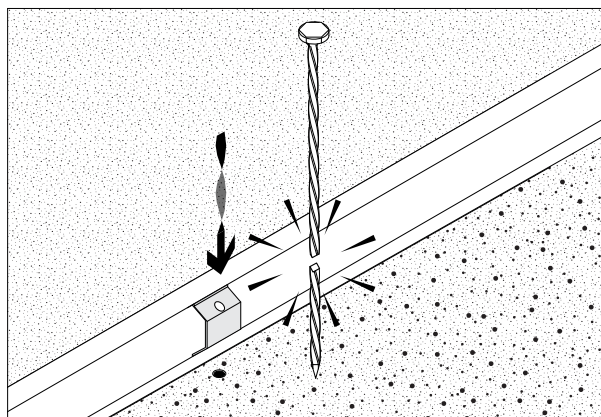

JOINING EDGE TO A SURFACE OR ROCK

A join tab can be made using an angle grinder. This involves cutting away the top lip portion and scoring a fragmented fold line for the remaining tab piece. The tab is then bent as required for fixing and screwing to the surface it joins.

If butting up to a rock, using a diamond tip blade to cut a slot in the rock itself allows the edge to sit into it snugly, or just use the rock to hide the edge end safely behind it.

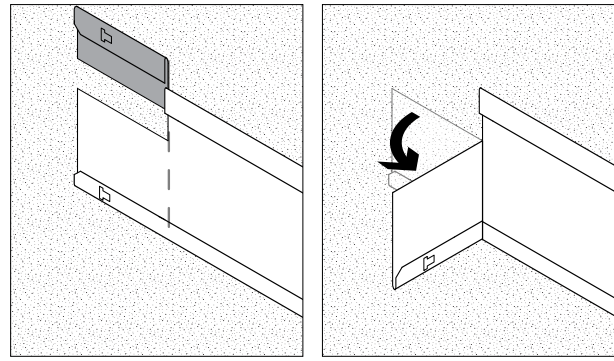

COMPATIBILITY

The 100mm Rigid is compatible with the 100mm Flex, because the joining plates and edge profile are exactly the same. This means you can use both together on the same project!

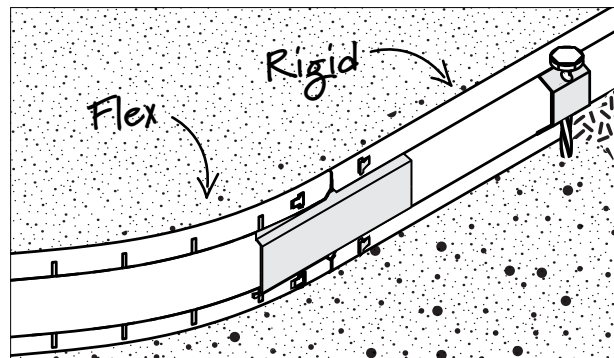

Straightcurve® Zero-Flex Garden Edging - 100mm

HL100WS WEATHERING STEEL | HL100GS GALVANISED STEEL

Product features

The details that make the difference

Connector plate and guide holes for precise and discreet joins



Two-way Continuous Foot for holding straight lines



Double wall and rolled top for structural strength



7mm rounded tops for child and pet safety

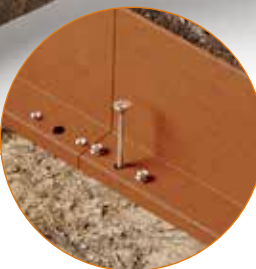

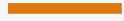

Moveable fixing spikes for easy obstacle avoidance

EDGE STYLE



FINISHES

-  Galvanised Steel
-  Weathering Steel

For lasting, perfectly straight unmovable lines

100mm

Product specifications

TECHNICAL SPECIFICATIONS

Length (Installed)	2200mm
Top edge thickness	7mm
Steel plate thickness	1.6mm
Weight per length	6.4kg

BULK BUYING

Pack quantity	22
Bulk pack weight inc. pallet	160kg

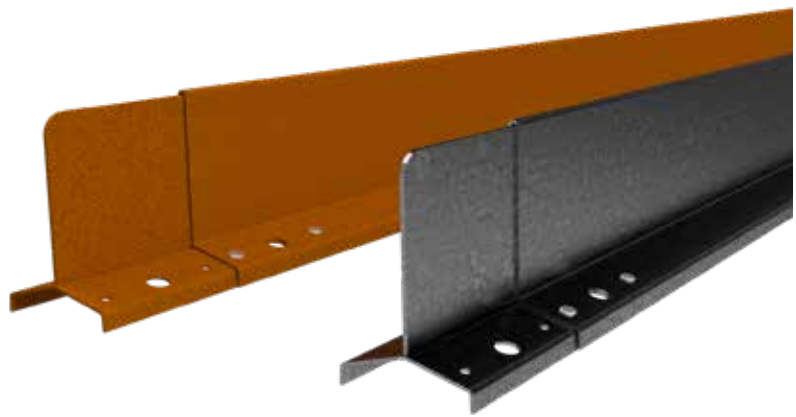

SOLD AS SET INCLUDING

- 1 x Connector plate (pre-attached)
- 4 x Galvanised spikes, 300mm long



ADDITIONAL ACCESSORIES

- 500mm (250mm + 250mm) Corner piece (reversible) (bend to desired angle)

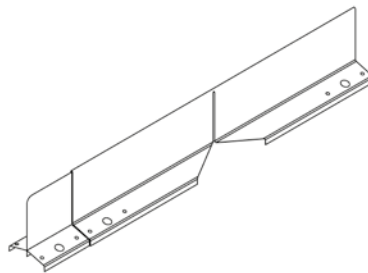

100mm Zero-Flex Installation Guide

Scan to watch the installation video



REQUIRED FIXINGS

- 4 x Tek Screws (12G x 16mm) or
- 4 x pop rivets (4mm shaft)

RECOMMENDED TOOLS

- Ground leveling tools
- Rubber mallet
- Cordless drill and Tek screw bit
- Angle grinder (only required if modifying lengths or fashioning ends)

PREPARATIONS

Mark the intended line on the ground to measure what length of edge is needed.

A firmer, compacted base is best for installing Zero-Flex and may need to be prepared first. This foundation is key for the edges strength and line holding capability.

For a retrofit, where surrounding heights are set, trench relative to these. For a new garden where surrounding materials may be added, the edge is sometimes installed without a trench, and then materials are filled up to and around it. The trench depth dictates the amount of edge that finishes proud and visible. Burying the edge more deeply adds strength, as does having firm flat ground as the foundation. Consider the 150mm Zero-Flex if more visibility of edge face is desired.

DO...

- ✓ Pay attention to best ground preparation for a firm foundation
- ✓ Get the depth of trench right the first time
- ✓ Join all lengths and corners in place and perfect the line before finally fixing in position

DON'T...

- ✗ Use all galvanised spikes on one side only
- ✗ Skip the screwing stage, these lock in the seamless join
- ✗ Accelerate rust with acids or salts, that's harmful to patina development
- ✗ Leave a square top corner unsafely protruding at an end, cap or round it off with a grinder instead

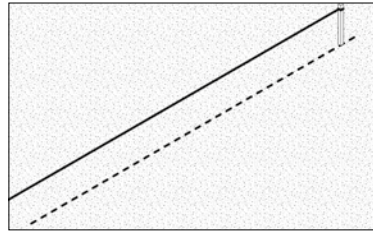

STEP 1 - Use string line or mark edge line on a firm base.

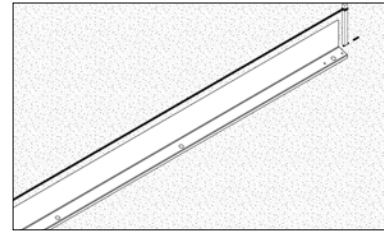

STEP 2 - Position first edges along the desired line.

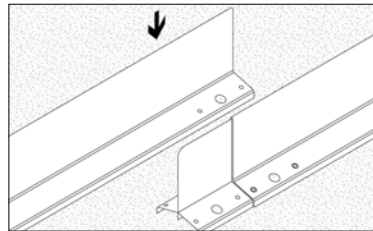

STEP 3 - Slide connector plate of one edge into the next to connect.

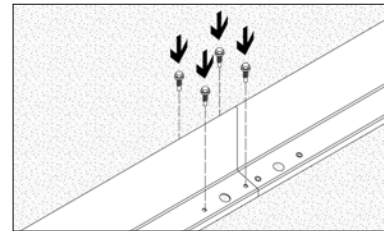

STEP 4 - Secure together with Tek screw through aligned guide holes.

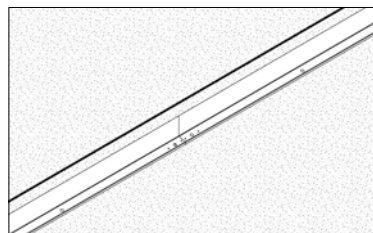

STEP 5 - Introduce further lengths, connecting them as you go along the install line.

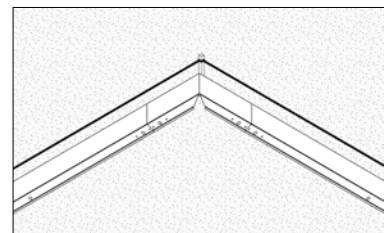

STEP 6 - Form and introduce corners where needed (lengths may need to be cut with grinder).

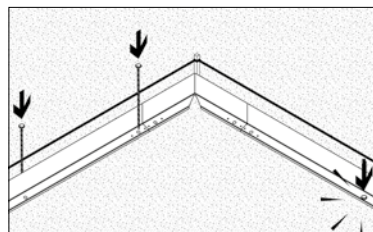

STEP 7 - Check position then hammer four galvanised spikes per length through foot holes, either side and evenly spaced.

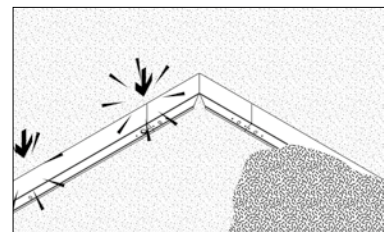

STEP 8 - Firming can be done with the rubber mallet, then backfill to finish

Bonus Tip! When is adding concrete footings a good idea?

For a Zero-Flex install on soft/sandy/shifting ground conditions consider setting the galvanised fixing spikes and the join sections into some concrete. Fill materials on both sides also add strength and can remove the need for concrete, but the foundation the edge sits on is always key to Zero-Flex's strength.

CORNERS

Standard corners are available for purchase, and their direction can be reversed when required by moving the connector plate to the other arm. Alternatively, you can choose to make your own corners. Making your own corners will likely mean less waste, as the corners are simply made where they are needed with no offcuts created.

Suggestion: Purchase one corner, and use that as a template for cutting in corners in other whole lengths where needed.

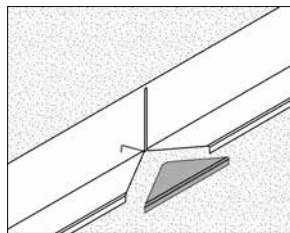

STEP 1 - Cut down the vertical wall (not to the very top) and cut away a V in the shoulder foot (at least 120 degrees) on the side where you will bend it in.

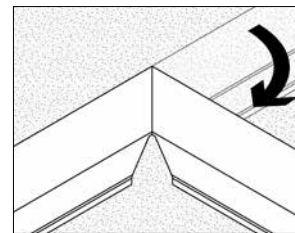

STEP 2 - Make a single cut on the opposing side shoulder (see step 1 diagram) then bend in the corner.

RECTANGLES & SQUARES

To create rectangles or squares be precise with your marking out before cutting. It's possible to join four corner pieces to easily make a 500mm x 500mm square. Similarly corners could be utilised with full lengths or part thereof, to make larger square or rectangular beds.

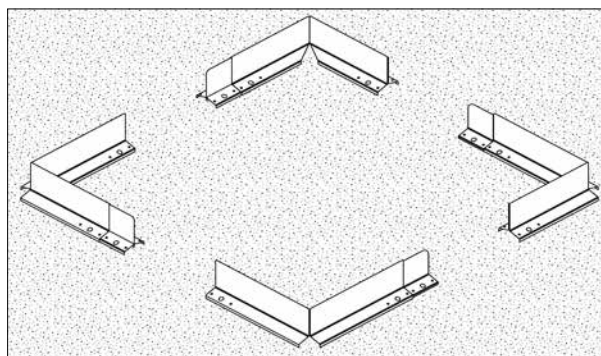

INSTALLING ON HARD SURFACES

The edge can be installed on a hard surface. When the surface is very hard but penetrable, use the galvanised spikes supplied. If the surface is impenetrable, such as with concrete, a bolt down approach (purchase separately) can be applied. Utilise the same fixing holes but use packers to raise the edge slightly to allow drainage away from the edge.

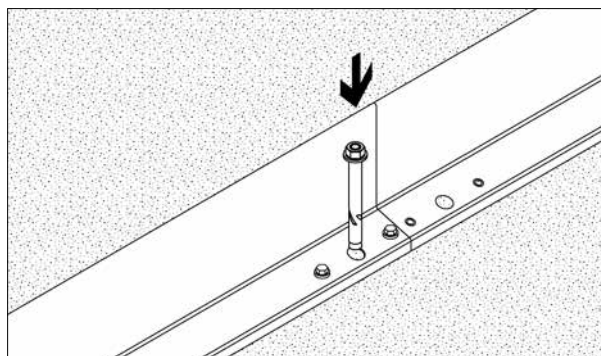

COMPATIBILITY

The Zero-Flex can have the equivalent height Flex product connected to it if a curved section is required. The top profiles are not exactly the same, but very similar when butted together. The Flex connector plate will slot into the Zero-Flex and would then need custom securing down low with some Tek screws.

Where the non-connector plate end of the flexline meets Zero-Flex Garden Edging (see adjacent pics), cut out a lower portion of the Flex edge to allow it to sit neatly onto the Zero-Flex edge connector plate and secure with screws.

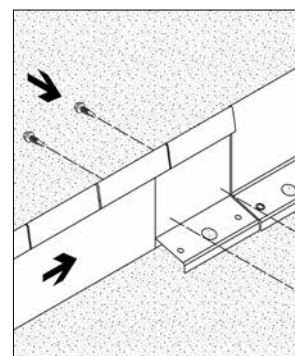
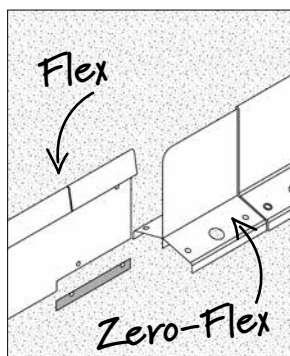

Technical Drawings

100mm

STRAIGHTCURVE® FLEX GARDEN EDGING - 100MM

Thickness: 1.6mm

Material: Galvanised, Weathering Steel

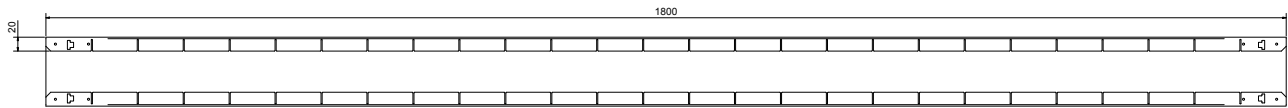

STRAIGHTCURVE® RIGID GARDEN EDGING - 100MM

Thickness: 1.6mm

Material: Galvanised, Weathering Steel

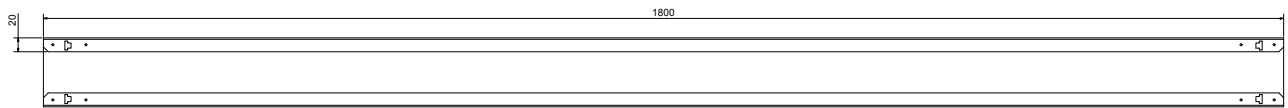

CONNECTOR PLATE FLEX

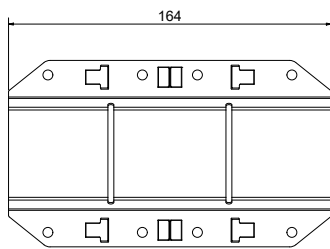

CONNECTOR PLATE RIGID

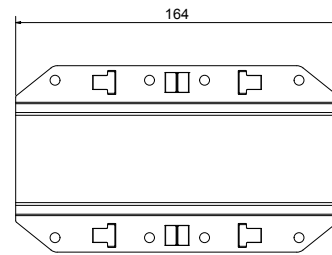

UNIVERSAL SIDE PROFILE

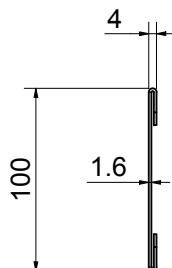



100mm

STRAIGHTCURVE® ZERO-FLEX GARDEN EDGING - 100MM

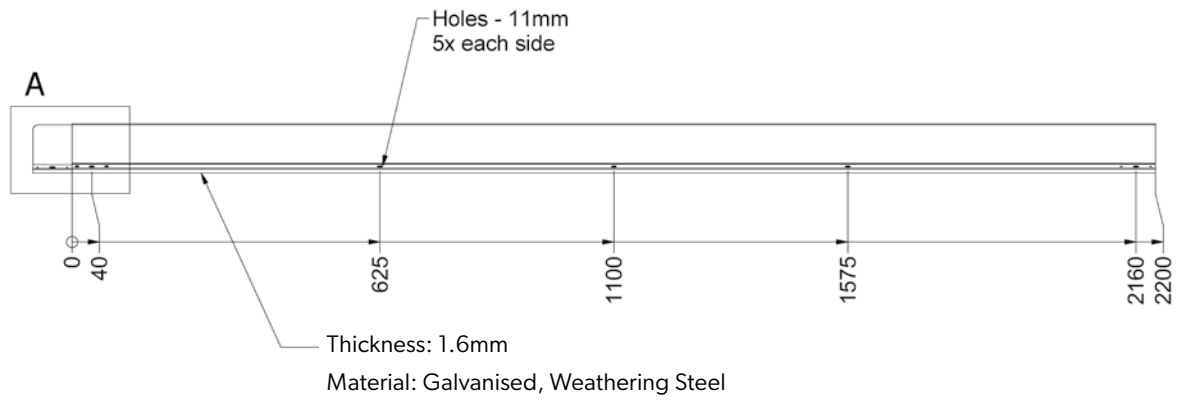

SIDE PROFILE

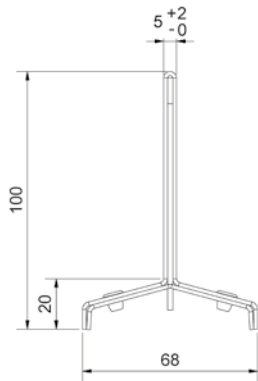

CONNECTORPLATE

